

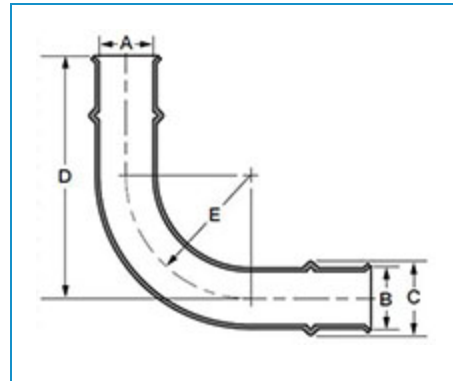

RLS LLC
833-RLS-FAST (833-757-3278)

Part Number 3031121200111, 3031 - 90° Elbow - Press x Press

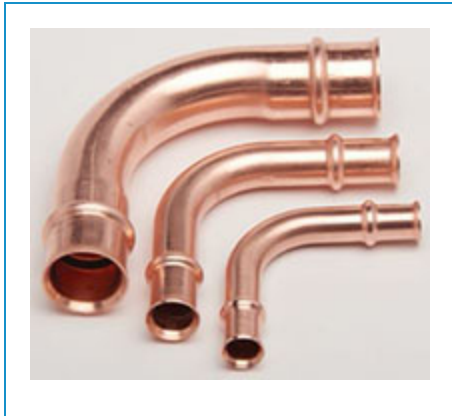

[Specifications](#) | [Dimensions](#)

Specifications

Size 1	3/4
Size 2	3/4
Fitting Body Material	Refrigerant Grade Copper, per ASTM-B75 or ASTM-B743
O-Ring Material	HNBR
Maximum Rated Pressure (MRP)	700 psi
Continuous Operating Temperature	250 °F
End Type	Press End
Weight	0.308 lb

Dimensions

Angle	90 °
A	0.76 in
B	0.88 in
C	1.07 in
D	3.47 in
E	1.76 in