







Location:



Origins™

9605-PLR
Shower/Hand Shower System
Specification Submittal



Model Numbers	Specification
<p><input type="checkbox"/> 9605-PLR <i>Origins Shower/Hand Shower System</i></p>	<p>Shower/hand shower system powered by the Temptrol® Pressure Balancing valve. Features 36" slide bar, separate two function diverter, in-line vacuum breaker, 60" flexible metal hose, ADA hand shower, 1 mode showerhead with easy to clean rubber nozzles and standard 2.5 gpm (9.5 L/min) flow restrictors. Components made from metal and nonmetallic materials plated in standard polished chrome finish.</p>
<p>Modifications</p> <ul style="list-style-type: none"> <input type="checkbox"/> -1.5  1.5 gpm (5.7 L/min) flow restrictor <input type="checkbox"/> -2.0  2.0 gpm (7.6 L/min) flow restrictor <input type="checkbox"/> -231 Super showerhead in place of Clear-Flo <input type="checkbox"/> -295 Institutional showerhead in place of Clear-Flo <input type="checkbox"/> -X Integral service stops <input type="checkbox"/> -CHKS Integral check stops <input type="checkbox"/> -IPS 1/2" female IPS connections <input type="checkbox"/> -REV Reverse coring for back to back installations <input type="checkbox"/> -LP Loop handle <input type="checkbox"/> -B Chrome brass escutcheon <input type="checkbox"/> -D Chrome brass dome cover <input type="checkbox"/> -VP Vandal proof escutcheon screws <input type="checkbox"/> -QD Quick disconnect on hand shower units <input type="checkbox"/> -R White vinyl hose in place of metal hose <input type="checkbox"/> -VB Elevated vacuum breaker <input type="checkbox"/> -OP 13" oval plate <input type="checkbox"/> -L/HD Less showerhead <input type="checkbox"/> -72 6' hose in place of 5' standard <input type="checkbox"/> -TRM Trim only, valve not included <input type="checkbox"/> -STN Satin Nickel finish 	<div style="text-align: right;">   </div> <hr/> <p>Compliance</p> <ul style="list-style-type: none"> -ASME A112.18.1/CSA B125.1 -WaterSense 1.5 gpm (5.7 L/min) 2.0 gpm (7.6 L/min) <p>(Compliance pending)</p> <div style="text-align: right;">   </div> <hr/> <p>Warranty</p> <p>Limited Lifetime - to the original end purchaser in consumer/residential installations. 5 Years - for industrial/commercial installations. Refer to www.symmons.com/warranty for complete warranty information.</p>
<p>Note: Append appropriate -suffix to model number.</p>	

Dimensions

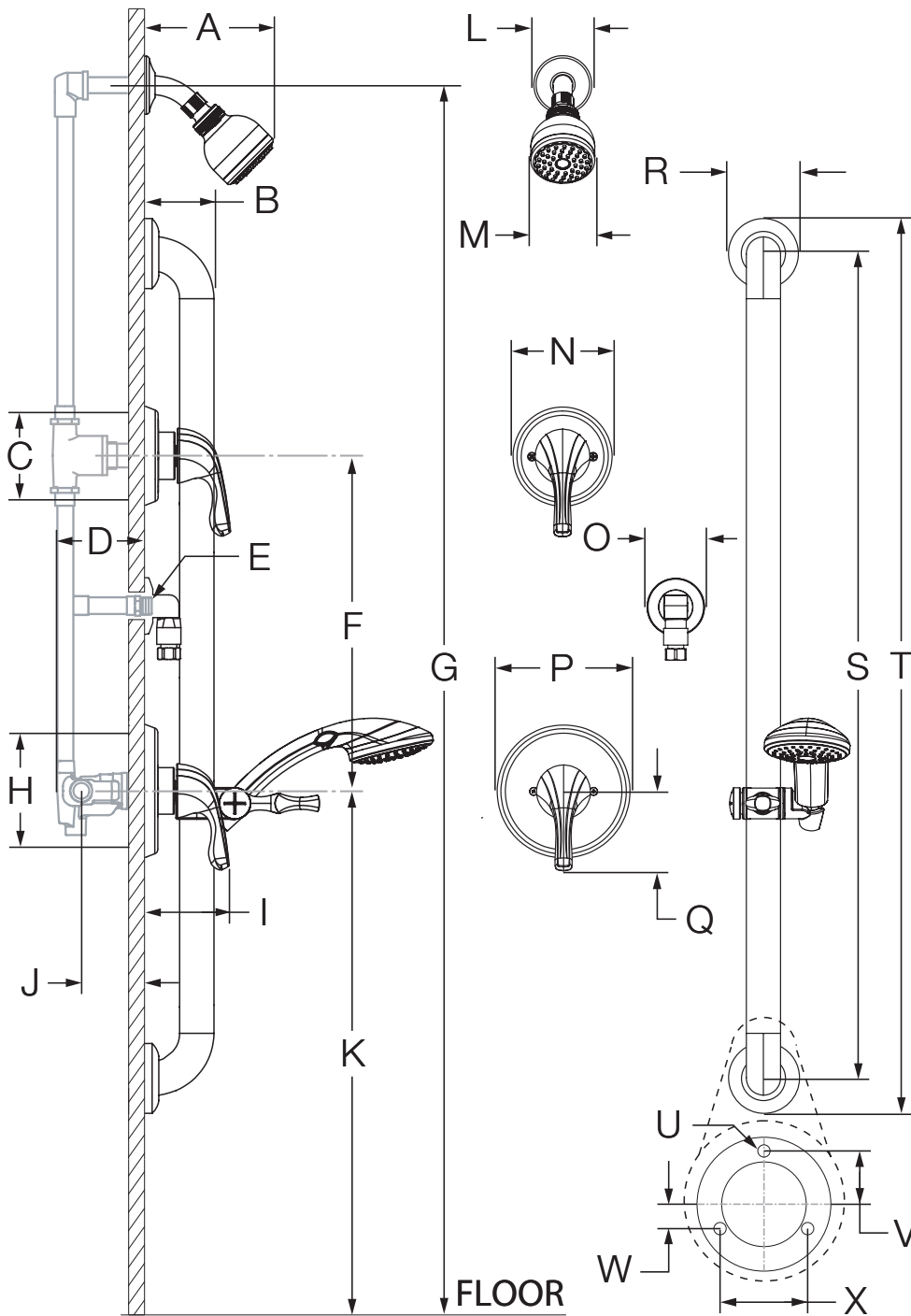

Measurements	
A	6 3/8", 162 mm
B	3", 76 mm
C	Diverter Valve Hole Size Min. Ø 3", 76 mm Max. Ø 3 1/4", 83 mm
D	3 1/2", 89 mm
E	Male 1/2" NPT fitting must protrude 3/8" from finished wall
F	Ref. 10", 254 mm
G	Ref. 77", 1956 mm
H	Shower Valve Hole Size Min. Ø 3", 76 mm Max. Ø 4", 102 mm
I	3 5/8", 92 mm
J	Rough-in 2 3/8" ± 1/2", 60 mm ± 13 mm
K	Ref. 42", 1067 mm
L	Ø 2 1/2", 64 mm
M	Ø 2 3/4", 70 mm
N	Ø 4 1/4", 108 mm
O	Ø 2 1/2", 64 mm
P	Ø 5 3/4", 146 mm
Q	3 3/8", 86 mm
R	Ø 3 1/8", 79 mm
S	36", 914 mm
T	39", 991 mm
U	(6x) Hole Size Ø 5/16", 8 mm
V	1", 25 mm
W	1/2", 13 mm
X	1", 25 mm

Notes:

- 1) All dimensions measured from nominal rough-in (see J as reference).
- 2) Dimensions subject to change without notice.