

Air conditioner

User manual

AR**TSFY**

- Thank you for purchasing this Samsung air conditioner.
- Before operating this unit, please read this user manual carefully and retain it for future reference.



SAMSUNG

Contents

Safety Information	4
Safety Information	4
At a Glance	11
Indoor Unit Overview	11
Display	12
Remote Control Overview	13
Replacing the remote control batteries	13
Remote Control Operation	14
Selecting an operation mode	14
To set the temperature • To adjust the fan speed • To adjust the airflow direction	15
Setting the Current time	16
Smart Features	17
Power Smart Features	17
AI Auto mode	17
Auto mode • Cool mode	18
Dry mode • Fan mode	19
Heat mode • Automatic defrost	20
Variety Smart Features	21
Fast function	21
Quiet function • Beep function	22
Display lighting function • Wi-Fi function (SmartThings app)	23
Energy-Saving Features	24
Electricity consumption check • Usage time check	24
Eco function	25
Timed on/ Timed off function	26
good'sleep function	27

Cleaning and Maintenance	28
Schedule	28
Cleaning	29
Appendix	33
Troubleshooting	33
SmartThings app	35

Safety Information



WARNING: Read This Manual

Read and follow all safety information and instructions before installation, use, or maintenance of this appliance. Incorrect installation, use, or maintenance of this appliance can result in death, serious injury, or property damage. Keep these instructions with this appliance. This manual is subject to change. For the latest version, www.samsunghvac.com.

Because the instructions in this manual cover various models, the characteristics of your air conditioner may differ slightly from those described. If you have any questions, please contact your service provider or visit www.samsunghvac.com.

This device complies with Industry Canada license exempt RSS standard(s). Operation is subject to the following two conditions: (1) this device may not cause harmful interference and (2) this device must accept any interference received, including interference that may cause undesired operation. This Class B digital apparatus complies with Canadian ICES-003.

Notices and notes

To make you aware of safety messages and highlighted information, we use the following notices and notes throughout this manual:



WARNING

Hazards or unsafe practices that may result in severe personal injury or death.



CAUTION

Hazards or unsafe practices that may result in minor personal injury or property damage.



IMPORTANT

Information of special interest



NOTE

Supplementary information that may be useful

FOR GENERAL

California Proposition 65 Warning (US)

 **WARNING:** Cancer and Reproductive Harm - www.P65Warnings.ca.gov.

FOR INSTALLATION

 **WARNING**

Use a power cord with this product's power specifications or higher and use the power cord for this appliance only. In addition, do not use an extension cord.

- Extending the power cord may result in electric shock or fire.
- Do not use an electric transformer. This may result in electric shock or fire.
- If the voltage/frequency/rated current condition is different, it may cause fire.

The installation of this appliance must be performed by a qualified technician or service company.

- Failing to do so may result in electric shock, fire, explosion, problems with the product, or injury and may also void warranty on the installed product.

Install an Isolation Switch next to the Air Conditioner (but not on the panels of the Air Conditioner) and circuit breaker dedicated to the air conditioner.

- Failing to do so may result in electric shock or fire.

Fix the outdoor unit firmly so that the electric part of the outdoor unit is not exposed.

- Failing to do so may result in electric shock, fire, explosion, or problems with the product.

Do not install this appliance near a heater, or inflammable material. Do not install this appliance in a humid, oily or dusty location, in a location exposed to direct sunlight and water (or rain). Do not install this appliance in a location where gas may leak.

- This may result in electric shock or fire.

Never install the outdoor unit in a location such as on a high external wall where it could fall.

- If the outdoor unit falls, it may result in injury, death or property damage.

This appliance must be properly grounded. Do not ground the appliance to a gas pipe, plastic, water pipe, or telephone line.

- Failing to do so may result in electric shock, fire, and explosion.
- Make sure to use a socket-outlet with ground.

Safety Information



CAUTION

Install your appliance on a level and hard floor that can support its weight.

- Failing to do so may result in abnormal vibrations, noise, or problems with the product.

Install the drain hose properly so that water drains correctly.

- Failing to do so may result in water overflowing and property damage. Avoid adding drain to waste pipes as odours may arise in the future.

When installing the outdoor unit, make sure to connect the drain hose so that draining is performed correctly.

- The water generated during heating by the outdoor unit may overflow and result in property damage.
In particular, in winter, if a block of ice falls, it may result in injury, death or property damage.

Do not install the product in a place where thermo-hygrostat is needed (such as server room, machinery room, computer room, etc.)

- Those places do not provide guaranteed operation condition of the product therefore performance can be poor in these places.

FOR POWER SUPPLY



WARNING

When the circuit breaker is damaged, contact a qualified installer or HVAC service company.

Do not pull or excessively bend the power line. Do not twist or tie the power line. Do not hook the power line over a metal object, place a heavy object on the power line, insert the power line between objects, or push the power line into the space behind the appliance.

- This may result in electric shock or fire.

If the supply cord is damaged, it must be replaced by the manufacturer, its service agent or similarly qualified persons in order to avoid a hazard.



CAUTION

When not using the air conditioner for a long period of time or during a thunder/lightning storm, cut the power at the circuit breaker.

- Failing to do so may result in electric shock or fire.

FOR USING



WARNING

If the appliance is flooded, please contact a qualified installer or HVAC service company.

- Failing to do so may result in electric shock or fire.

If the appliance generates a strange noise, a burning smell or smoke, cut off the power supply immediately and contact a qualified installer or HVAC service company.

- Failing to do so may result in electric shock or fire.

In the event of a gas leak (such as propane gas, LP gas, etc.), ventilate immediately without touching the power line. Do not touch the appliance or power line.

- Do not use a ventilating fan.
- A spark may result in an explosion or fire.

Safety Information

To reinstall the air conditioner, please contact a qualified installer or HVAC service company.

- Failing to do so may result in problems with the product, water leakage, electric shock, or fire.
- Delivery service for the product is not provided. If you reinstall the product in another location, additional construction expenses and an installation fee will be charged.
- Especially, when you wish to install the product in an unusual location such as in an industrial area or near the seaside where it is exposed to salt in the air, please contact a qualified installer or HVAC service company.

Do not touch the circuit breaker with wet hands.

- This may result in electric shock.

Do not turn the air conditioner off with the circuit breaker while it is operating.

- Turning the air conditioner off and then on again with the circuit breaker may cause a spark and result in electric shock or fire.

After unpacking the air conditioner, keep all packaging materials well out of the reach of children, as packaging materials can be dangerous to children.

- If a child places a bag over its head, it may result in suffocation.

Do not touch the airflow blade with your hands or fingers during heating.

- This may result in electric shock or burns.

Do not insert your fingers or foreign substances into the air inlet/outlet of the air conditioner.

- Take special care that children do not injure themselves by inserting their fingers into the product.

Do not strike or pull the air conditioner with excessive force.

- This may result in fire, injury, or problems with the product.

Do not place an object near the outdoor unit that allows children to climb onto the machine.

- This may result in children seriously injuring themselves.

Do not use this air conditioner for long periods of time in badly ventilated locations or near infirm people.

- Since this may be dangerous due to a lack of oxygen, open a window at least once an hour.

If any foreign substance such as water has entered the appliance, cut off the power supply and contact a qualified installer or HVAC service company.

- Failing to do so may result in electric shock or fire.

Do not attempt to repair, disassemble, or modify the appliance yourself.

- Do not use any fuse (such as copper, steel wire, etc.) other than the standard fuse.
- Failing to do so may result in electric shock, fire, problems with the product, or injury.

**CAUTION**

Do not place objects or devices under the indoor unit.

- Water dripping from the indoor unit may result in fire or property damage.

Check that the installation frame of the outdoor unit is not broken at least once a year.

- Failing to do so may result in injury, death or property damage.

To prevent personal injury, make sure that you change the directions of the horizontal airflowblades after stopping the movements of the vertical airflowblade. (In case of adjusting the horizontal airflow manually)

Do not install the product in a ship or a vehicle (such as a campervan).

- Salt, vibration or other environmental factor may cause the product malfunction, electric shock or fire.

Do not stand on top of the appliance or place objects (such as laundry, lighted candles, lighted cigarettes, dishes, chemicals, metal objects, etc.) on the appliance.

- This may result in electric shock, fire, problems with the product, or injury.

Do not operate the appliance with wet hands.

- This may result in electric shock.

Do not spray volatile material such as insecticide onto the surface of the appliance.

- As well as being harmful to humans, it may also result in electric shock, fire or problems with the product.

Do not drink the water from the air conditioner.

- The water may be harmful to humans.

Do not hit, shake, drop, or attempt to disassemble the remote control.

When replacing the remote control batteries, keep them out of the reach of infants.

- If an infant eats batteries, contact a doctor immediately.

When replacing the remote control batteries, be careful not to get the battery fluid on your skin.

- Battery fluid is harmful to humans.

Safety Information

Do not touch the pipes connected with the product.

- This may result in burns or injury.

Do not use this air conditioner to preserve precision equipment, food, animals, plants or cosmetics, or for any other unusual purposes.

- This may result in property damage.

Avoid directly exposing humans, animals or plants to the airflow from the air conditioner for long periods of time.

- This may result in harm to humans, animals or plants.

FOR CLEANING



WARNING

Do not clean the appliance by spraying water directly onto it. Do not use benzene, thinner or alcohol to clean the appliance.

- This may result in discolouration, deformation, damage, electric shock or fire.

Before cleaning or performing maintenance, cut off the power supply and wait until the fan stops.

- Failing to do so may result in electric shock or fire.



CAUTION

Take care when cleaning the surface of the heat exchanger of the outdoor unit since it has sharp edges.

- This should be done by a qualified technician. Please contact a qualified installer or HVAC service company.

Do not clean the inside of the air conditioner by yourself.

- For cleaning inside the appliance, contact a qualified installer or HVAC service company.
- When cleaning the filter, refer to the descriptions in the 'Cleaning' section.
- Failing to do so may result in damage, electric shock or fire.
- Make sure to prevent any injury from sharp edges of the surface when handling the heat exchanger.

Indoor Unit Overview

The appearance of the actual product may differ slightly from the image below.

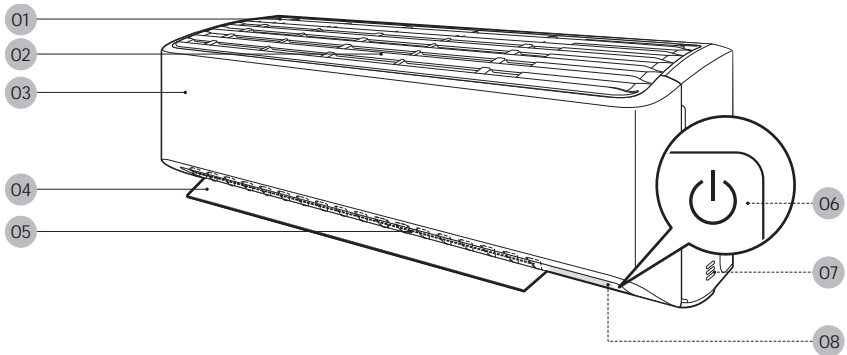

- | | |
|--------------------------------|---|
| 01 Air intake | 05 Airflow blade (left and right) |
| 02 Air filter | 06 Power button/Remote control receiver |
| 03 Front panel | 07 Room temperature sensor |
| 04 Airflow blade (up and down) | 08 Display |

Indoor Unit Overview

Display

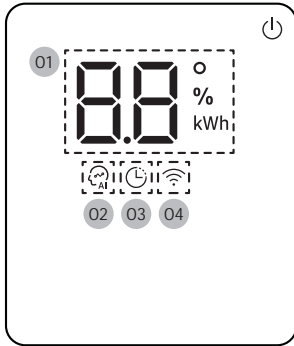

- 01 Temperature indicator (numeric)
Filter reset indicator (⏏ F)
Electricity consumption indicator (numeric)
Auto clean indicator (⏏ i)
Defrost indicator (dF)
- 02 AI Auto indicator
- 03 Timer indicator
good'sleep indicator
- 04 Wi-Fi indicator

NOTE

- If the Wi-Fi indicator blinks for 10 seconds when operation starts, it means that the air conditioner is not connected to Wi-Fi. See "SmartThings app" on page 35 and connect the air conditioner to Wi-Fi.
- When connected to Wi-Fi, the air conditioner can gather and learn your user patterns so that it can run in AI Auto mode.

Remote Control Overview

Most operating instructions in this manual require using the remote control.

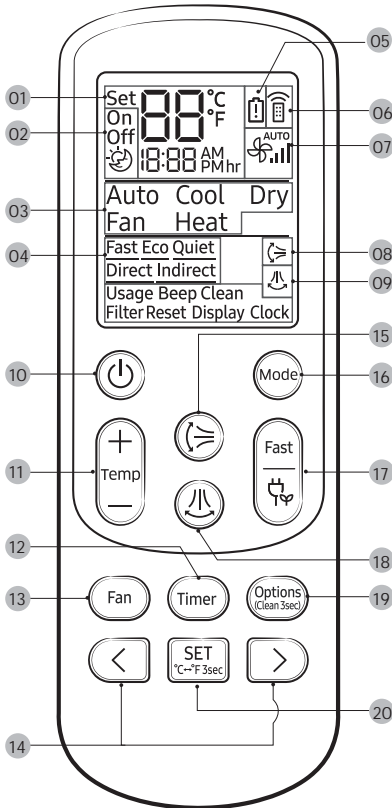

- 01 Set temperature indicator
 - 02 Timer option indicator
 - 03 Operation mode indicator
 - 04 Options indicator
 - 05 Low battery indicator
 - 06 Transmit indicator
 - 07 Fan speed indicator
 - 08 Vertical air swing indicator
 - 09 Horizontal air swing indicator
 - 10 Power button
 - 11 Temperature button
 - 12 Timer button
 - 13 Fan speed button
 - 14 Direction button/Selection button
 - 15 Vertical air swing button
 - 16 Mode button
 - 17 Fast/Eco button
 - 18 Horizontal air swing button
 - 19 Options/Clean button
 - 20 SET button/Temperature type button(°C↔°F)
- The horizontal air swing function is not available for this model. Horizontal airflow can be adjusted manually.

NOTE

- Although **Purify**,  (Horizontal air swing), **Direct** and **Indirect** appear on the remote control display, they are not available on this model.

Replacing the remote control batteries

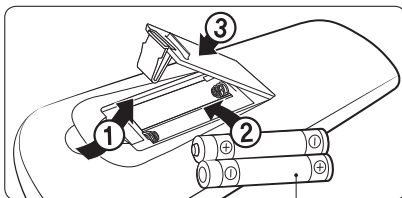

Two 1.5V AAA batteries

Remote Control Operation

You can use the air conditioner easily by selecting a mode and then by controlling the temperature, fan speed, and air direction.

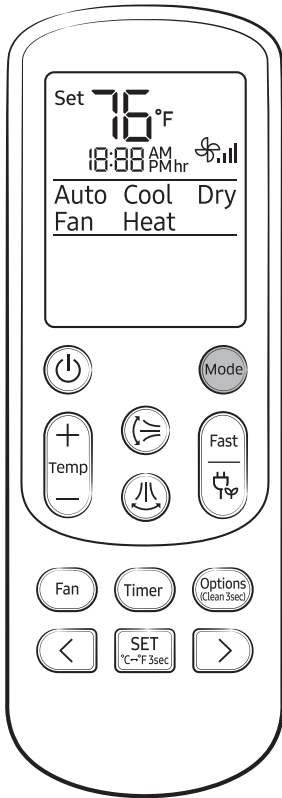

At a Glance

Selecting an operation mode

To change the current mode between Auto, Cool, Dry, Fan, and Heat, press the **Mode** (Mode) button.

You can use AI Auto mode after Wi-Fi is connected.

NOTE

You can use the Cool, Dry, and Heat modes in the following operation range.

Mode	Cool	Dry	Heat
Indoor temperature	61 °F to 90 °F (16 °C to 32 °C)	65 °F to 90 °F (18 °C to 32 °C)	81 °F or less (27 °C or less)
Outdoor temperature	14 °F to 115 °F (-10 °C to 46 °C)	14 °F to 115 °F (-10 °C to 46 °C)	-5.1 °F to 75 °F ¹⁾ (-20.6 °C to 24 °C)
Indoor humidity	Relative humidity of 80 % or less ²⁾	—	—

¹⁾ If the outdoor temperature drops to -5.1 °F (-20.6 °C), the heating capacity may decrease by as much as 60-70 %.

²⁾ If the air conditioner operates in Cool mode in a high-humidity environment for an extended period of time, condensation may occur.

You can switch between Celsius and Fahrenheit indications on the remote control.



▶ Press and hold for 3 or more seconds.

NOTE

- The temperature indications on the indoor unit are not switched.
- This function is canceled when the remote control batteries are replaced. In this case, run this function again.

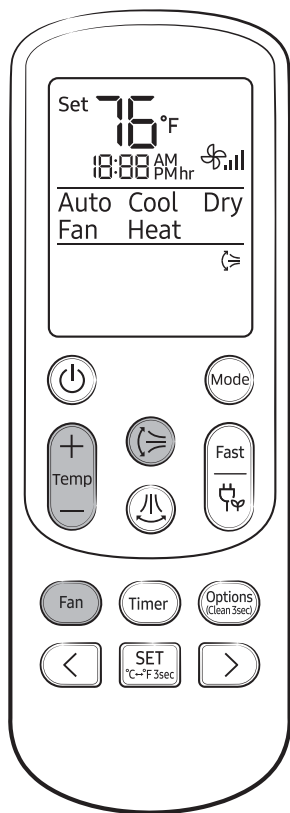











To set the temperature

To control the temperature in each mode, press the  (Temperature) button:

Mode	Temperature control
AI Auto/Auto/Cool	Adjust by 1 °F from 61 °F to 86 °F (16 °C to 30 °C).
Heat	Adjust by 1 °F from 47 °F to 86 °F (8 °C to 30 °C).
Dry	Adjust by 1 °F from 65 °F to 86 °F (18 °C to 30 °C).
Fan	No temperature control.

To adjust the fan speed

Select from the following fan speeds in each mode:

Mode	Available fan speeds
AI Auto/Auto/Dry	 (Auto)
Cool/Heat	 (Auto),  (Low),  (Med),  (High),  (Turbo)
Fan	 (Low),  (Med),  (High),  (Turbo)

To adjust the airflow direction

Keep the airflow in a constant direction by stopping the movements of the vertical airflow blades.

In operation ► 

NOTE

- If you adjust the vertical airflow blade manually, it may not close completely when you turn off the air conditioner.
- Always use the remote control to adjust the airflow blades. Do not move the blades by hand. They may not operate normally.
- You cannot control the vertical airflow direction in Cool mode when the good'sleep function is on.

Remote Control Operation

At a Glance

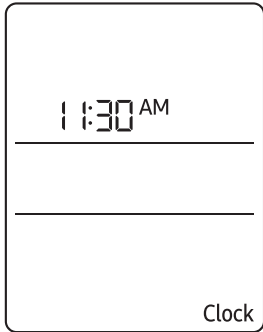

Setting the Current time

Before using the functions of the air-conditioner, set the current time.



NOTE

- You can set the time in hourly units from 1 hour to 12 hours according to AM, PM and in minute units from 0 to 59 minutes.
- Current time setting will be cancelled if you don't press the  (SET) button within 10 seconds after setting the time. Therefore, check for the current time on the remote controller display.

Power Smart Features

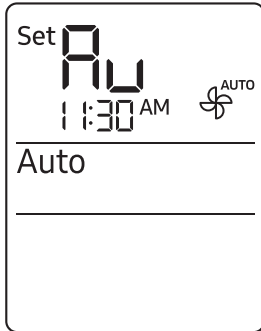



AI Auto mode

Use AI Auto mode to automatically operate any of Cool, Dry and Heat modes depending on the learned user patterns gathered from an external server via Wi-Fi module. The favourite temperature and operation mode are also set based on the current temperatures (indoor/outdoor) and the gathered user patterns.



NOTE

- You can use this mode after Wi-Fi is connected. Otherwise, Auto mode is activated.
- In AI Auto mode, the  (AI Auto) and  (Wi-Fi) indicators appears on the display of the indoor unit.
- If the gathered user patterns are not sufficient, the set temperature is set to 75 °F(24 °C).
- The set temperature is controlled within the range of 72 °F to 79 °F(22 °C to 26 °C) in AI Auto mode. You can also change it manually.
- When you press  (Mode) in AI Auto mode, the mode is cancelled.
- If you change the set temperature in AI Auto mode, it automatically changes back to the AI comfort temperature after 1 hour.

Power Smart Features

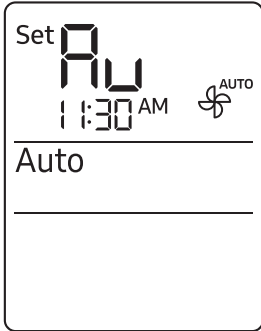

Auto mode

Use Auto mode to perform the powerful cooling or heating function to automatically reach the desired temperature. When the difference between the room temperature and the set temperature decreases, the air conditioner controls the fan speed and airflow direction.



NOTE

- If Wi-Fi cannot be connected or the Wi-Fi function is not supported, this Auto mode is automatically activated instead of AI Auto mode.
- When the room temperature is higher than the set temperature, the air conditioner automatically produces cool air.
- When the room temperature is lower than the set temperature, the air conditioner automatically produces warm air.

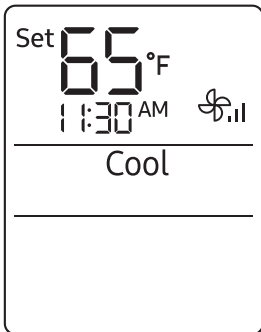

Cool mode

Use Cool mode to stay cool in hot weather.



NOTE

- For comfort, keep the temperature difference between the indoor and outdoor air within 9 °F (5 °C).
- After selecting Cool mode, select the desired function, temperature, and fan speed.
 - To cool more quickly, select a lower temperature and a faster fan speed.
 - To save energy, select a higher temperature and a slower fan speed.
 - As the room temperature nears the set temperature, the compressor motor will slow down to save energy.

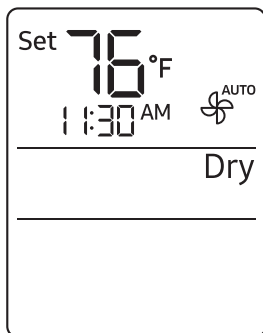

Dry mode

Use Dry mode in rainy or humid weather.



Select Dry.

NOTE

- The proper set temperature range for dehumidifying operation is 75 °F to 79 °F (24 °C to 26 °C). If you feel that the current humidity seems high, use a lower set temperature.
- You cannot use Dry mode for heating. Dry mode is designed to produce a cooling side-effect.

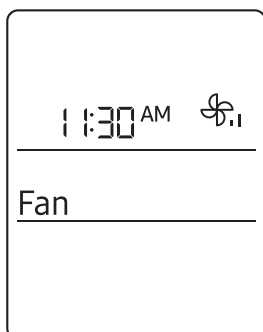

Fan mode

Use Fan mode to run the air conditioner like a floor fan, providing a breeze without heating or cooling.



Select Fan.

NOTE

- If the air conditioner will not be used for an extended period of time, run it in Fan mode for 3 to 4 hours to dry the internal components.
- The outdoor unit does not operate in Fan mode. This is normal and not a fault with the air conditioner.

Power Smart Features

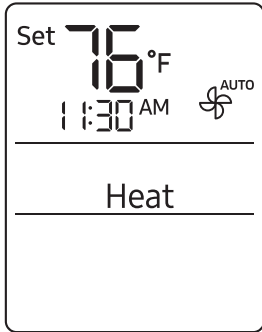

Heat mode

Use Heat mode to stay warm.



NOTE

- While the air conditioner warms up, the fan may not operate for about 3 to 5 minutes at the beginning to prevent cold blasts.
- If the air conditioner heats insufficiently, use an additional heating appliance in combination with the air conditioner.

Automatic defrost

When the outdoor temperature is low and the humidity is high, frost may develop on the outdoor heat exchanger, which may decrease heating efficiency. When these conditions are met while Heat mode is on, the air conditioner runs the Defrost function for 5 to 12 minutes to remove frost from the outdoor heat exchanger.

NOTE

- When the Defrost function is on, the **df** (Defrost) indicator appears on the indoor unit display, steam is produced on the outdoor unit, the air conditioner moves the airflow blades to the lowest position to prevent cold air from coming out from the indoor unit.
- You cannot select other functions with the remote control until the Defrost function is finished.

Variety Smart Features

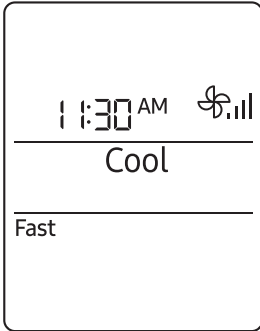

Fast function

Use the Fast function to quickly cool or heat your room. This function is the most powerful cooling and heating function provided by the air conditioner. You can select this function in Cool or Heat mode.

In Cool or Heat mode ► 

NOTE

- You can change the airflow direction, but you cannot change the set temperature and the fan speed.
- When you select the Fast function in Heat mode, you may not be able to increase the fan speed for 3 to 5 minutes while the unit heats up.
- Selecting the Fast function cancels the Eco, good'sleep, and Quiet functions.
- You can also start the Fast function from the Options menu:

In Cool or Heat mode ►  ►   ►

Select Fast. ► 

Variety Smart Features

Smart Features

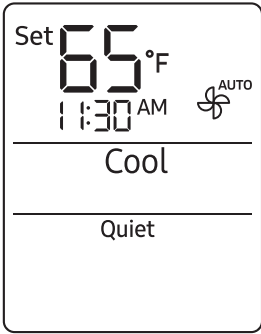

Quiet function

Use the Quiet function to reduce the unit's operating noise. You can select this function in Cool or Heat mode.



NOTE

- You can change the set temperature and the airflow direction, but you cannot change the fan speed.
- Selecting the Quiet function cancels the Eco, good'sleep, and Fast functions.

Beep function

Use the Beep function to turn on or off the beep that sounds when you press a button on the remote control.



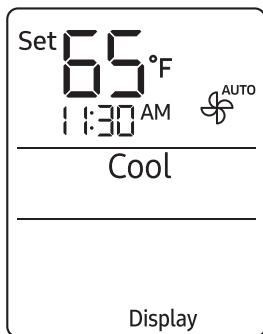

Display lighting function

Use the Display lighting function to turn on or off the lighting of the indoor unit display.



NOTE

- If you change the current mode or function when the Display lighting function is on, the display lighting turns on for 5 seconds and then turns off again.
- To turn off the Display lighting function, run the method above again or turn the product off and on.

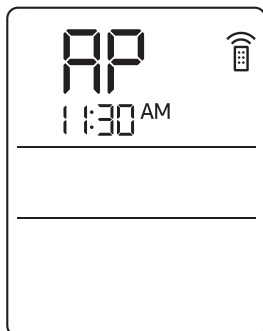

Wi-Fi function (SmartThings app)

Turn on the Wi-Fi function to pair your smartphone with the air conditioner.

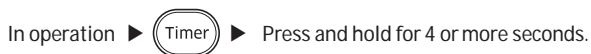

NOTE

- When you turn on the Wi-Fi function, your smartphone pairs with the air conditioner, the  (Transmit) indicator blinks, and **AP** appears on the remote control display for a few seconds.
- Once your smartphone is connected with the air conditioner, you can control it via the wireless Internet using the SmartThings app installed on your smartphone.
- For more information about how to prepare your smartphone for connection and how to control the air conditioner using the SmartThings app, see "SmartThings app" on page 35.

Energy-Saving Features

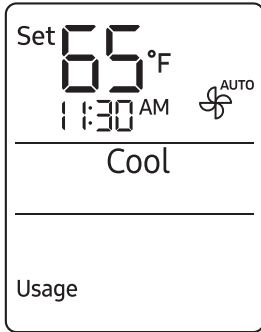

Electricity consumption check

For the multi system, this function is not supported.

Use the Usage function to check the amount of electricity consumed by using the air conditioner. The amount consumed is displayed on the indoor unit display for a few seconds, and the set temperature appears.

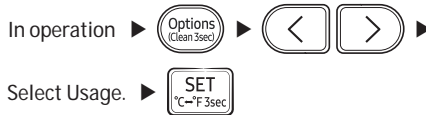

The value range displayed is between 0.1 kWh and 99 kWh. Electricity consumption is calculated from the moment the air conditioner turns on. The value is reset when the air conditioner turns off.

NOTE

- The usage shown on the indoor unit display may slightly differ from the amount of electricity actually consumed.
- You can view electricity consumption only when the air conditioner is operating.

Usage time check

For the single system, this function is not supported.

Use the Usage time function to check the operation duration from the moment when the air conditioner is turned on to the moment when the Usage time function is selected. The usage time is displayed on the indoor unit display for a few seconds, and the set indoor temperature appears.

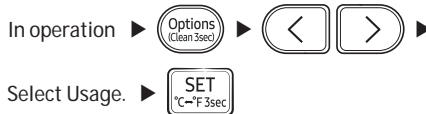

The usage time is displayed in units of hour. For example, 0.1 is equivalent to 6 minutes; 2.5, 2 hours and 30 minutes; 3.7, 3 hours and 42 minutes. The value range displayed is between 0.0 and 99. The value is reset when the air conditioner turns off.

NOTE

- The usage time shown on the indoor unit display may a little differ from the actual operation time of the air conditioner.
- You can view the usage time only when the air conditioner is operating.

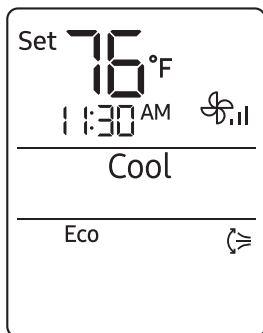

Eco function

For the multi system, this function is not supported.

Use the Eco function to reduce electricity consumption while staying cool or warm. You can select this function in Cool or Heat mode.

In Cool or Heat mode ▶

NOTE

- When the Eco function starts, the pattern appears on the remote control for a few seconds and vertical air swing begins.
- You can change the set temperature, airflow direction, and fan speed.
- The allowed set temperatures while the Eco function is on are:

Mode	Minumum set temperature	Maximum set temperature
Cool	76 °F (24 °C)	86 °F (30 °C)
Heat	47 °F (8 °C)	86 °F (30 °C)

- If you change the set temperature to be outside the allowed range for the current mode, the set temperature is automatically reset to be within the range.
- When you turn off the Eco function, the air swing continues. Use the (Vertical air swing) button to turn it off.
- Selecting the Eco function cancels the good'sleep, Fast, and Quiet functions.
- You can also start the Eco function from the Options menu:

In Cool or Heat mode ▶ ▶ ▶

Select Eco. ▶

Energy-Saving Features

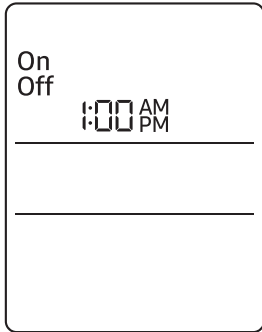

Timed on/ Timed off function

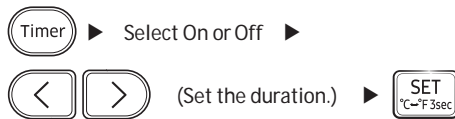

Use the Timed on/off function to turn the air conditioner on or off after a duration. Scheduling durations before the air conditioner turns on or off helps use the air conditioner economically.

- Check the current time on the remote controller before using this function.
- The default time is 1 AM on the remote controller. The current time is reset to default time after changing the batteries.



NOTE

- You can set the time in hourly units from 1 hour to 12 hours according to AM, PM and in minute units from 0 to 59 minutes. Set the time interval to - : - - to cancel the Timed on/off function.
- When you start the Timed on/off function, the ⌚ (Timer) indicator appears on the indoor unit display.
- After starting the Timed on function, you can change the mode and the set temperature. You cannot change the set temperature while the Fan mode is running.
- You cannot set the same duration for both Timed on and Timed off functions.

Combining Timed on and Timed off	
When the air conditioner is off	Example: Timed on 3 hours, Timed off 5 hours The air conditioner turns on 3 hours after the last time you press the  (SET) button to start the Timed on/off function, remains on for 2 hours, then turns off again.
When the air conditioner is on	Example: Timed on 3 hours, Timed off 1 hour The air conditioner turns off 1 hour after the last time you press the  (SET) button to start the Timed on/off function, remains off for 2 hours, then turns on again.

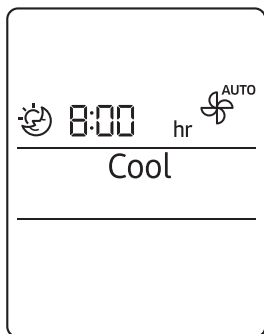

good'sleep function

Use the good'sleep function to save energy while you are sleeping. You can select this function in Cool or Heat mode.

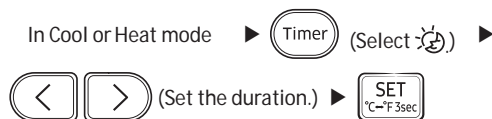

NOTE

- You can adjust the set temperature by 1 °F between 61 °F(16 °C) and 86 °F(30 °C) (Cool) / 47 °F(8 °C) and 86 °F(30 °C) (Heat).
- When you start the good'sleep function, the ⌚ (Timer) indicator appears on the indoor unit display.
- You can set the time in half hour unit from 30 minutes to 3 hours and hour unit from 3 to 12 hours. Set the operation time to - : - - to cancel the good'sleep function.
- The recommended set temperatures while the good'sleep function is on are:

Mode	Recommended set temperature	Optimal set temperature
Cool	77 °F to 81 °F (25 °C to 27 °C)	79 °F (26 °C)
Heat	70 °F to 73 °F (21 °C to 23 °C)	72 °F (22 °C)

- The default operation time for the good'sleep function is 8 hours. If the operation time is set to over 5 hours, the Wake up function begins 1 hour before the set time. The air conditioner stops automatically when the operation time expires in the cool mode, the air conditioner will run the function that you have started most recently in the heat mode.
- When the Timed on, Timed off, and good'sleep functions are overlapped, the air conditioner operates its timer with only the function that you have started most recently.
- Selecting the good'sleep function cancels Eco, Fast, and Quiet functions.

Schedule

Task	How often	By whom	Instruction
Run the Auto clean function.	As needed	Owner	"Auto clean function" on page 29.
Clean the filter.	Once every two weeks	Owner	"Cleaning the filter" on page 32.
Clean the exterior of the indoor unit.	As needed	Owner	"Cleaning the outside of the indoor unit" on page 31.
Clean the exterior of the outdoor unit.	At least once a year	Owner	"Cleaning the heat exchanger on the outdoor unit" on page 31.
Replace the remote control batteries	As needed	Owner	"Replacing the remote control batteries" on page 13.
Apply corrosion inhibitor on outdoor unit. (Only if installed near salt water such as an ocean)	At least once a year	Qualified technician	Contact your service provider.
Clean inside the indoor or outdoor unit.	Once a year	Qualified technician	Contact your service provider.
Inspect the units, electrical connections, refrigerant tubes, and protections.	Once a year	Qualified technician	Contact your service provider.

Cleaning

Auto clean function

Use the Auto clean function if the indoor unit produces odors.

Activating Auto clean

To activate Auto clean, press the  (Options) button for at least 3 seconds.

The indoor unit display shows:



If the air conditioner is off, Auto clean starts immediately. If the air conditioner is running, Auto clean starts as soon as the air conditioner turns off.

NOTE

- You can also activate Auto clean from the Options menu:



- Once Auto clean is selected, it is always activated whenever the air conditioner turns off.
- Auto clean runs for 10 to up to 30 minutes depending on internal dry conditions. The indoor unit display shows the cleaning progress from 1% to 99%.
- If you start another function while Auto clean is progressing, Auto clean pauses and will resume when the other function stops.
- When Auto clean completes, the air conditioner turns off.
- Auto clean does not run after Heat or Fan mode.

Cleaning

Canceling Auto clean

To cancel Auto clean while it is running, follow the procedure below:

 ► Press and hold for 3 or more seconds.

OR

 ►   ► Select Clean. ► 

NOTE

- Canceling Auto clean does not deactivate it.

Deactivating Auto clean

To deactivate Auto clean, follow the procedure below while the air conditioner is in operation or turned off:

 ►   ► Select Clean. ► 

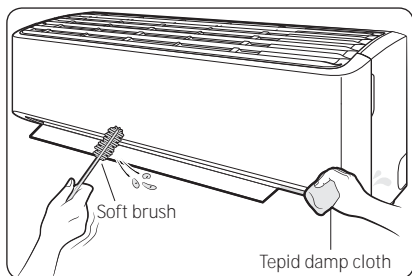

Cleaning the outside of the indoor unit

- 1 Turn off the air conditioner and wait until the fan stops.
- 2 Disconnect the power supply.
- 3 Use a soft brush or tepid damp cloth to clean the exterior.

WARNING

- Do not clean the appliance by spraying water directly onto it. Water entering the unit may result in electric shock or fire that could cause death, serious injury, or property damage:

CAUTION

- Do not use an alkaline detergent to clean the indoor unit display.
- Do not use sulphuric acid, hydrochloric acid, or organic solvents such as paint thinner, kerosene, acetone, benzene, or alcohol to clean the unit surfaces.

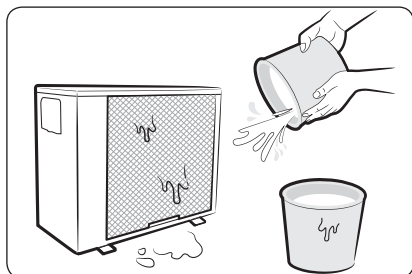

Cleaning the heat exchanger on the outdoor unit

- 1 Turn off the air conditioner and wait until the fan stops.
- 2 Disconnect the power supply.
- 3 Spray water on the heat exchanger to remove dust and other debris.

CAUTION

- Do not use sulphuric acid, hydrochloric acid, or organic solvents such as paint thinner, kerosene, acetone, benzene, or alcohol to clean the unit surfaces.
- If you need to inspect or clean the inside of the heat exchanger on the outdoor unit, contact a local service centre for help.

Cleaning

Cleaning the filter

Clean the air filter every two weeks or when the **F** (filter-cleaning reminder) appears on the indoor unit display. The time between cleanings may vary, depending on the usage and environmental conditions.

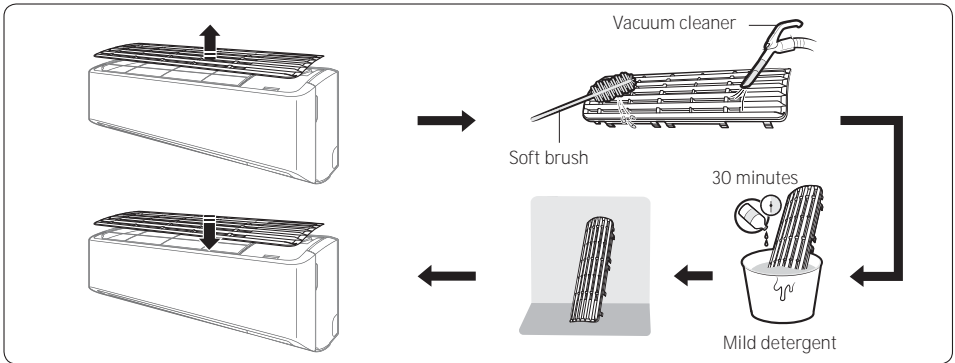

- 1 Slide the filter off of the unit.
- 2 Use a soft brush or vacuum cleaner to remove any dust or debris on the filter.
- 3 Soak the filter in a solution of water and mild detergent for 30 minutes.
- 4 Rinse the filter and let it air dry in a well-ventilated area that is out of direct sunlight.
- 5 Reinstall the filter.
- 6 Reset the filter-cleaning reminder:

In operation ▶ **Options** (Clean 3sec) ▶ **<** **>** ▶ Select Filter Reset. ▶ **SET** °C-°F 3sec

⚠ CAUTION



- Take care not to damage the filter during cleaning.
- Do not scrub the air filter with a hard-bristle brush or another cleaning utensil.
- Do not expose the air filter to direct sunlight when drying it.

Troubleshooting

If the air conditioner is not operating normally, refer to the troubleshooting guide below.

Problem	Solution
The air conditioner stops working.	<ul style="list-style-type: none"> • Make sure the unit is receiving power. • Check the circuit breaker. If it is flipped off, flip it on again and restart the unit. If the problem persists, contact your service provider. • The Timed off function may have turned off the unit. Turn on the unit again.
Cannot change the temperature.	<ul style="list-style-type: none"> • Check if the unit is in Fan or Fast mode. If so, you cannot change the set temperature; the unit automatically controls the set temperature.
Improper airflow temperature.	<ul style="list-style-type: none"> • Check the set temperature. In Cool mode, cooling occurs only when the set temperature is lower than the current temperature. In Heat mode, heating occurs only when the set temperature is higher than the current temperature. • Use the  (Temperature) button on the remote control to change the set temperature. • Check if the air filter is blocked with dirt or debris. If the air filter is blocked, the cooling and heating performance may decrease. Clean the air filter regularly (page 32). • Check if the outdoor unit is covered or is installed near obstacles. Remove the coverings and obstacles. • Check if the Defrost function is on (page 20). During defrost, the fan stops and warm air does not come out. • Check if doors or windows are open. This may cause poor circulation or performance. Close all doors and windows. • Check if the pipe length between the units exceeds the maximum pipe length (see "Typical installation" in the Installation manual). If so, the cooling and heating performance may decrease.
Cannot change the airflow direction.	<ul style="list-style-type: none"> • Check if the good'sleep function is on in Cool mode. If so, you cannot control the airflow direction.
Cannot change the fan speed.	<ul style="list-style-type: none"> • Check if the unit is in Auto, Dry, or Fast mode or the good'sleep function is on in Cool mode. In these conditions, you cannot control the fan speed; the unit automatically controls the fan speed.

Troubleshooting

Problem	Solution
The remote control does not work.	<ul style="list-style-type: none"> • Replace the batteries in the remote control. • Make sure the remote control can send an unobstructed signal to the unit. • Keep bright lights away from the unit. Light from fluorescent bulbs or neon signs may interrupt the signal from the remote control.
The Timed on/off function does not work.	<ul style="list-style-type: none"> • Make sure to press the  (SET) button on the remote control when setting the timer.
The indicator on the remote control blinks continuously.	<ul style="list-style-type: none"> • Press the  (Power) button to turn off the unit, or disconnect the power plug. • If the indicator light on the remote control continues blinking, contact your service provider.
Odors are coming from the unit during regular operation.	<ul style="list-style-type: none"> • If the unit is operating in a smoky area, ventilate the room or operate the unit in Fan mode for 3 to 4 hours. There are no components in the unit that produce a strong odor. • Check if the drain lines are clean. Clean them regularly.
The remote control display shows an error message.	<ul style="list-style-type: none"> • If the indoor unit indicator blinks, write down the error code. Contact your service provider and provide them with the error code.
The unit is generating noise.	<ul style="list-style-type: none"> • It is normal for the unit to generate some noise while operating. If the pipe length between the units is less than 3 m and no coil was used (see "Typical installation" in the Installation manual), additional noise may be transmitted from the outdoor unit to the indoor unit via the piping.
Smoke is coming from the outdoor unit.	<ul style="list-style-type: none"> • In winter, most likely this is steam coming from the outdoor heat exchanger while the Defrost function is on.
Water drips from the pipe connections on the outdoor unit.	<ul style="list-style-type: none"> • Condensation may develop when the ambient temperature or humidity changes significantly. This is normal.

SmartThings app

The SmartThings app may change without prior notice to improve product usability and performance. Use the SmartThings app on your smartphone to control the air conditioner via the wireless Internet. To remotely control the air conditioner, you need to connect your smartphone to the air conditioner. If already connected, skip to "Step 6. Controlling the air conditioner with your smartphone" on page 36.

Step 1. Checking the requirements for connection

Before connecting your smartphone with the air conditioner, make sure that the following requirements are met:

- Wi-Fi access point: 2.4 GHz Wi-Fi access point only
- The air conditioner and your smartphone must be within the coverage of the same Wi-Fi access point and connected to it. After the connection, you can control the air conditioner from any place via various wireless networks such as Wi-Fi, 3G, LTE and 5G.
- Recommended Android phones: Android 6.0 or later, at least 2 GB RAM
- Supported Apple phones: iOS 10.0 or later, iPhone 6 or later
- Android tablets and iPads are not supported.

Step 2. Connecting your smartphone to the Wi-Fi network

- 1 Turn on the Wi-Fi access point.
- 2 Tap **Settings** → **Wi-Fi** on your smartphone.
- 3 Tap the **Wi-Fi** switch to activate it, and then select the 2.4 GHz Wi-Fi access point to connect to.
- 4 If needed, enter the password for the access point.
- 5 Tap **Advanced**.
- 6 Top the **Switch to mobile data** switch to deactivate it.

Step 3. Installing the SmartThings app

If the SmartThings app is not installed on your smartphone, follow the procedure below. If installed, skip to "Step 4. Configuring the SmartThings app" on page 35.

- 1 Launch **Play Store** or **App Store**.
- 2 Tap the search field, and then search for "SmartThings".
- 3 Tap **INSTALL** for the found SmartThings app item.
- 4 Select **Agree**.

Step 4. Configuring the SmartThings app



After the SmartThings app is installed, follow the procedure below to configure it. If already configured, skip to "Step 5. Connecting your smartphone to the air conditioner" on page 36.

- 1 Launch the **SmartThings** app.
- 2 When you see pop-up windows asking for location, Wi-Fi, Bluetooth permissions, tap **Start**.
- 3 Tap **Log In**.
- 4 If you have no Samsung account, tap **Add account** to create your Samsung account.
- 5 Log in to your Samsung account.
- 6 Consent to **TERMS AND CONDITIONS**.
- 7 When you see a pop-up window asking for access permission to location information, tap **ALLOW**.

SmartThings app

Step 5. Connecting your smartphone to the air conditioner

- 1 Plug in the power cord of the air conditioner, and then turn on the power.
- 2 Launch the **SmartThings** app.
- 3 Tap **Add device** on the home screen of the SmartThings app.
- 4 Tap **ADD DEVICE MANUALLY**.
- 5 Tap **Air conditioner > Room air conditioner**.
- 6 Press the  (Timer) button on the remote control for at least 4 seconds.

To notify that registration of the selected air conditioner to your Samsung account is in progress, the  (Transmit) indicator blinks for several seconds and **RF** appears on the remote control display. When the connection is finished, the  (Transmit) indicator turns off and **RF** disappears. A new device card for the selected air conditioner is added to the home screen of the SmartThings app.

Step 6. Controlling the air conditioner with your smartphone

- 1 Launch the **SmartThings** app.
- 2 On the home screen of the SmartThings app, tap the device card for the air conditioner, which was added when you proceeded with "Step 5. Connecting your smartphone to the air conditioner" on page 36.
- 3 Refer to the table on the next page and remotely control the air conditioner with your smartphone.

WARNING

- RF exposure warning statement – for keeping 20cm distance when installing this module.
- Warning that this module should not be installed and operating simultaneously with other radio without additional evaluation or FCC filing.

- Instruction for host system labeling, the host system should have proper label showing that it "Contains FCC ID : A3LSWL-B70F"
- Your device uses non-harmonised frequency and is intended for use in all European countries. The WLAN can be operated in the EU without restriction indoors, but cannot be operated outdoors in France.

Specifications

Wi-Fi	
Frequency Range	Transmitter Power(Max)
2412 - 2472 MHz	20 dBm

Open Source Announcement

The software included in this product contains open source software. You may obtain the complete corresponding source code for a period of three years after the last shipment of this product by sending an email to mailto:oss.request@samsung.com.

It is also possible to obtain the complete corresponding source code in a physical medium such as a CD-ROM; a minimal charge will be required.

The following URL http://opensource.samsung.com/opensource/SMART_AT_051/seq/0 leads to the download page of the source code made available and open source license information as related to this product. This offer is valid to anyone in receipt of this information.



Category	Function	Description
Monitoring	Set temperature	Displays the set temperature.
	Current temperature	Displays the current temperature.
Control	Power	Turns the air conditioner on or off.
	Mode	Selects the desired operation.
	Temperature	Adjusts the indoor set temperature.
	Fan Speed	Sets the fan speed of operation mode.
	Wind direction	Sets the fan directions of operation mode.
	Schedule	<p>Sets the Timed on/off function.</p> <ul style="list-style-type: none"> The maximum number of schedules you can set using the Timed on/off function is 10. The set times for the Timed on and Timed off functions must be different. Once the Timed on/off function is set, the setting remains even if you unplug the air conditioner and plug in it again.
	Options	<p>Selects an option function of operation mode.</p> <ul style="list-style-type: none"> The available options might be different depending on the air conditioner model. The fan speed and airflow direction are set automatically according to the selected options. For detailed information on the options of the product, see page 17 – 23.
Settings	<p>Sets additional functions.</p> <ul style="list-style-type: none"> Press the Settings button on the control screen to check or set detailed information of air conditioner. The functions of Clean, Filter, and Beep can be set. <ul style="list-style-type: none"> When the Beep function is off, the beep sound from the device will be mute. 	

SAMSUNG