

Location:









# Origins™

S-9601-PLR  
Shower System

## Specification Submittal



Model Numbers	Specification
<input type="checkbox"/> <b>S-9601-PLR</b> <i>Origins Shower System</i>	<p>Shower system powered by the Temptrol® Pressure Balancing valve. Features integrated volume control, 1 mode showerhead with easy to clean rubber nozzles and standard 2.5 gpm (9.5 L/min) flow restrictor. Components made from metal and nonmetallic materials plated in standard polished chrome finish.</p>
<p><b>Modifications</b></p> <ul style="list-style-type: none"> <li><input type="checkbox"/> <b>-1.5</b>  1.5 gpm (5.7 L/min) flow restrictor</li> <li><input type="checkbox"/> <b>-2.0</b>  2.0 gpm (7.6 L/min) flow restrictor</li> <li><input type="checkbox"/> <b>-231</b> Super showerhead in place of Clear-Flo</li> <li><input type="checkbox"/> <b>-295</b> Institutional showerhead in place of Clear-Flo</li> <li><input type="checkbox"/> <b>-X</b> Integral service stops</li> <li><input type="checkbox"/> <b>-CHKS</b> Integral check stops</li> <li><input type="checkbox"/> <b>-IPS</b> 1/2" female IPS connections</li> <li><input type="checkbox"/> <b>-REV</b> Reverse coring for back to back installations</li> <li><input type="checkbox"/> <b>-LP</b> Loop handle</li> <li><input type="checkbox"/> <b>-B</b> Chrome brass escutcheon</li> <li><input type="checkbox"/> <b>-D</b> Chrome brass dome cover</li> <li><input type="checkbox"/> <b>-VP</b> Vandal proof escutcheon screws</li> <li><input type="checkbox"/> <b>-OP</b> 13" oval plate</li> <li><input type="checkbox"/> <b>-L/HD</b> Less showerhead</li> <li><input type="checkbox"/> <b>-TRM</b> Trim only, valve not included</li> <li><input type="checkbox"/> <b>-STN</b> Satin Nickel finish</li> </ul>	<div style="text-align: right;">   </div> <hr/> <p><b>Compliance</b></p> <ul style="list-style-type: none"> <li>-ASME A112.18.1/CSA B125.1</li> <li>-WaterSense 1.5 gpm (5.7 L/min) 2.0 gpm (7.6 L/min)</li> </ul> <p>(Compliance pending)</p> <div style="text-align: right;">   </div> <hr/> <p><b>Warranty</b></p> <p><b>Limited Lifetime</b> - to the original end purchaser in consumer/residential installations.  <b>5 Years</b> - for industrial/commercial installations.  Refer to <a href="http://www.symmons.com/warranty">www.symmons.com/warranty</a> for complete warranty information.</p>
<p><b>Note:</b> Append appropriate -suffix to model number.</p>	

## Dimensions

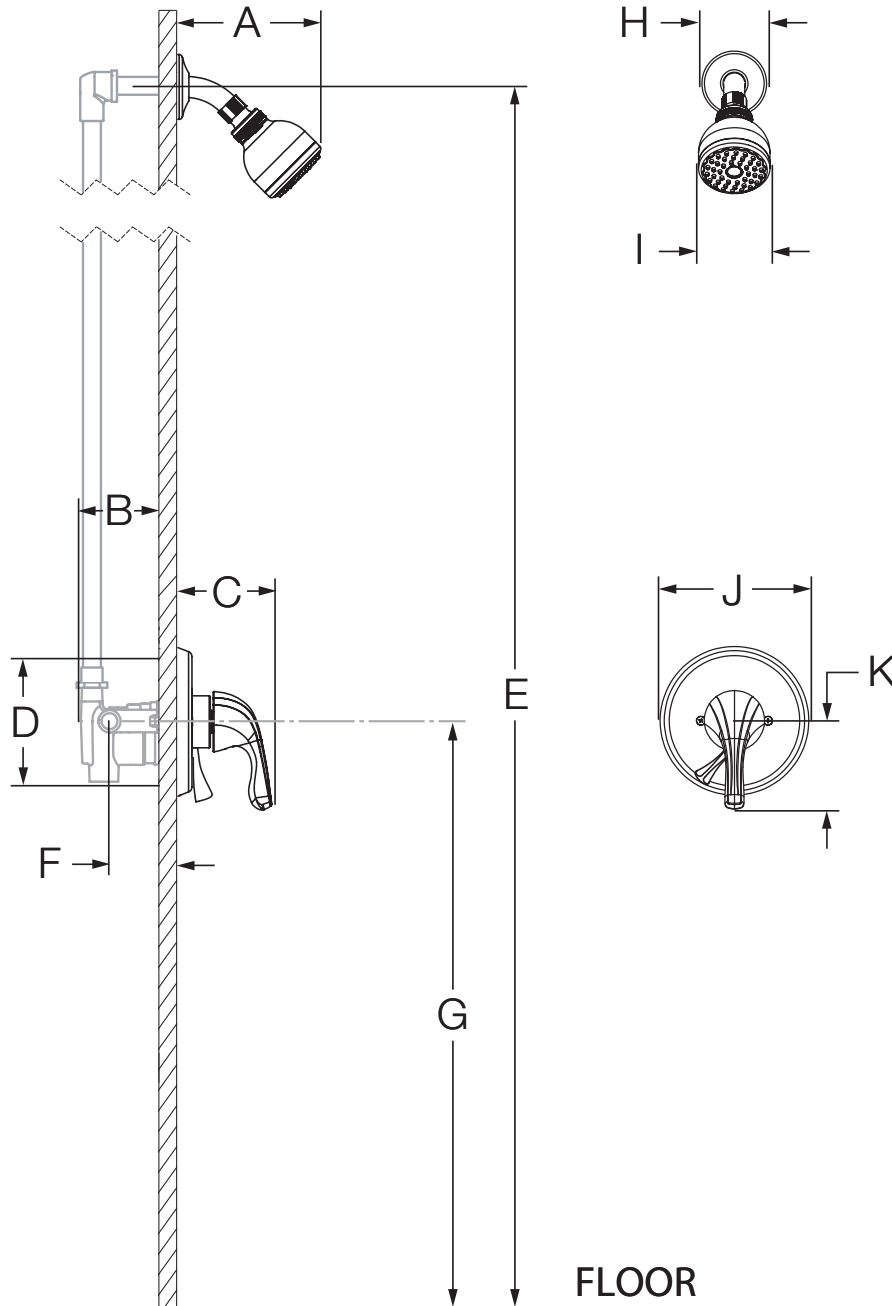

Measurements	
A	6 3/8", 162 mm
B	3 1/2", 89 mm
C	3 5/8", 92 mm
D	Shower Valve Hole Size Min. Ø 3", 76 mm Max. Ø 4", 102 mm
E	Ref. 77", 1956 mm
F	Rough-in 2 3/8" ± 1/2", 60 mm ± 13 mm
G	Ref. 42", 1067 mm
H	Ø 2 1/2", 64 mm
I	Ø 2 3/4", 70 mm
J	Ø 5 3/4", 146 mm
K	3 3/8", 86 mm

### Notes:

- 1) All dimensions measured from nominal rough-in (see F as reference).
- 2) Dimensions subject to change without notice.