

Location:









# SYMMONS<sup>®</sup> Origins<sup>™</sup>

the smart choice<sup>™</sup>

S-9606-PLR  
Tub/Shower/Hand Shower System  
**Specification Submittal**



Model Numbers	Specification
<input type="checkbox"/> <b>S-9606-PLR</b> <i>Origins Tub/Shower/Hand Shower System</i>	<p>Tub/shower/hand shower system powered by the Temptrol<sup>®</sup> Pressure Balancing valve. Features integrated volume control, 36" slide bar, separate three function diverter, non-diverter tub spout, in-line vacuum breaker, 60" flexible metal hose, ADA hand shower, 1 mode showerhead with easy to clean rubber nozzles and standard 2.5 gpm (9.5 L/min) flow restrictors. Components made from metal and nonmetallic materials plated in standard polished chrome finish.</p>
<p><b>Modifications</b></p> <ul style="list-style-type: none"> <li><input type="checkbox"/> <b>-1.5</b>  1.5 gpm (5.7 L/min) flow restrictor</li> <li><input type="checkbox"/> <b>-2.0</b>  2.0 gpm (7.6 L/min) flow restrictor</li> <li><input type="checkbox"/> <b>-231</b> Super showerhead in place of Clear-Flo</li> <li><input type="checkbox"/> <b>-295</b> Institutional showerhead in place of Clear-Flo</li> <li><input type="checkbox"/> <b>-SS</b> Slip spout on any tub/shower unit</li> <li><input type="checkbox"/> <b>-X</b> Integral service stops</li> <li><input type="checkbox"/> <b>-CHKS</b> Integral check stops</li> <li><input type="checkbox"/> <b>-IPS</b> 1/2" female IPS connections</li> <li><input type="checkbox"/> <b>-REV</b> Reverse coring for back to back installations</li> <li><input type="checkbox"/> <b>-LP</b> Loop handle</li> <li><input type="checkbox"/> <b>-B</b> Chrome brass escutcheon</li> <li><input type="checkbox"/> <b>-D</b> Chrome brass dome cover</li> <li><input type="checkbox"/> <b>-VP</b> Vandal proof escutcheon screws</li> <li><input type="checkbox"/> <b>-QD</b> Quick disconnect on hand shower units</li> <li><input type="checkbox"/> <b>-R</b> White vinyl hose in place of metal hose</li> <li><input type="checkbox"/> <b>-VB</b> Elevated vacuum breaker</li> <li><input type="checkbox"/> <b>-OP</b> 13" oval plate</li> <li><input type="checkbox"/> <b>-L/HD</b> Less showerhead</li> <li><input type="checkbox"/> <b>-72</b> 6' hose in place of 5' standard</li> <li><input type="checkbox"/> <b>-TRM</b> Trim only, valve not included</li> <li><input type="checkbox"/> <b>-STN</b> Satin Nickel finish</li> </ul>	<div style="text-align: right;">   </div> <hr/> <p><b>Compliance</b></p> <p>-ASME A112.18.1/CSA B125.1          -WaterSense 1.5 gpm (5.7 L/min)                            2.0 gpm (7.6 L/min)          (Compliance pending)</p> <div style="text-align: right;">   </div> <hr/> <p><b>Warranty</b></p> <p><b>Limited Lifetime</b> - to the original end purchaser in consumer/residential installations.  <b>5 Years</b> - for industrial/commercial installations.          Refer to <a href="http://www.symmons.com/warranty">www.symmons.com/warranty</a> for complete warranty information.</p>
<p><b>Note:</b> Append appropriate -suffix to model number.</p>	

## Dimensions

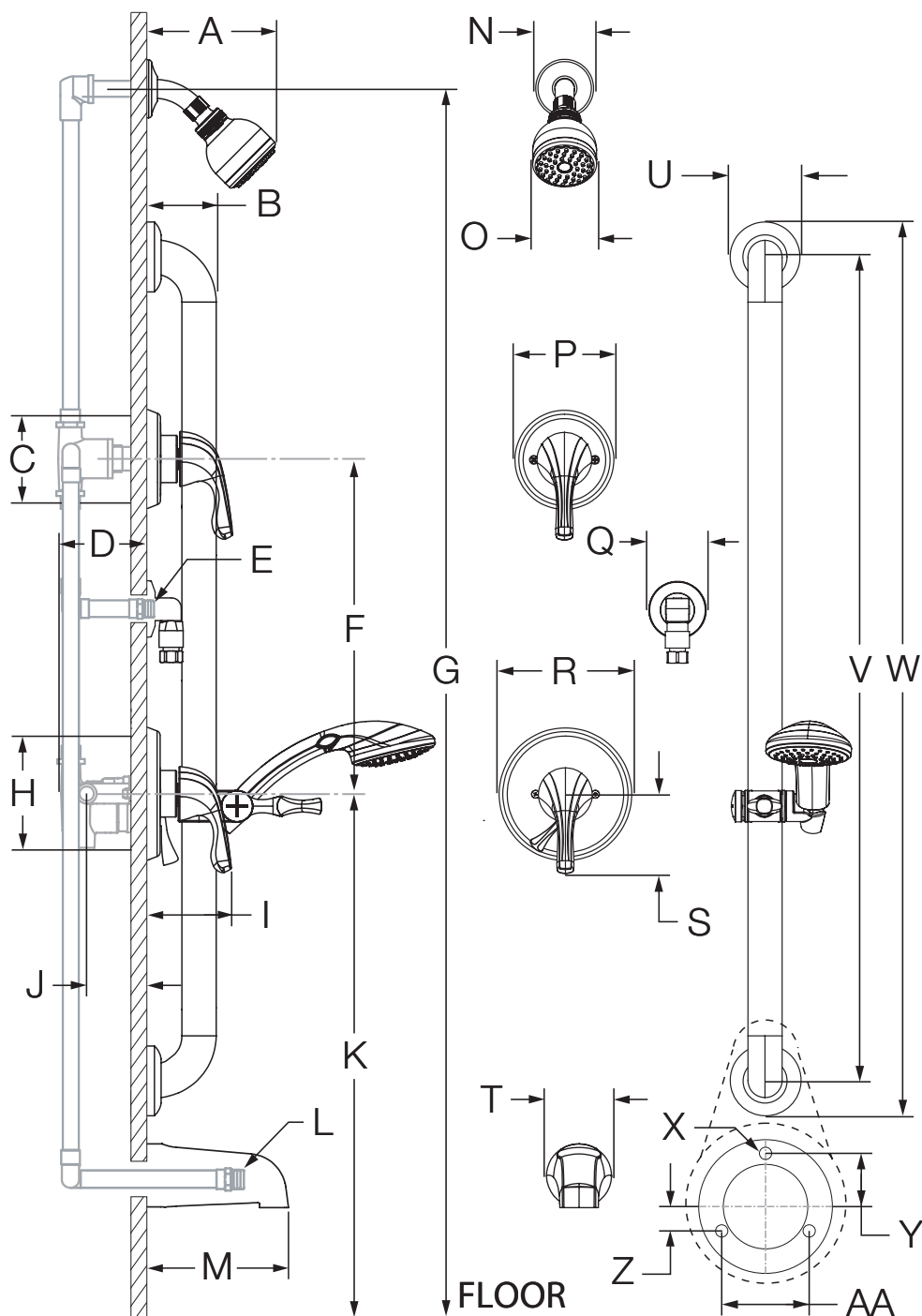

Measurements	
A	6 3/8", 162 mm
B	3", 76 mm
C	Diverter Valve Hole Size Min. Ø 3", 76 mm Max. Ø 3 1/4", 83 mm
D	3 1/2", 89 mm
E	Male 1/2" NPT fitting must protrude 3/8" from finished wall
F	Ref. 10", 254 mm
G	Ref. 77", 1956 mm
H	Shower Valve Hole Size Min. Ø 3", 76 mm Max. Ø 4", 102 mm
I	3 5/8", 92 mm
J	Rough-in 2 3/8" ± 1/2", 60 mm ± 13 mm
K	Ref. 32", 813 mm
L	Male 1/2" NPT fitting must protrude 4" from finished wall
M	5 1/2", 140 mm
N	Ø 2 1/2", 64 mm
O	Ø 2 3/4", 70 mm
P	Ø 4 1/4", 108 mm
Q	Ø 2 1/2", 64 mm
R	Ø 5 3/4", 146 mm
S	3 3/8", 86 mm
T	Ø 2 1/2", 64 mm
U	Ø 3 1/8", 79 mm
V	36", 914 mm
W	39", 991 mm
X	(6x) Hole Size Ø 5/16", 8 mm
Y	1", 25 mm
Z	1/2", 13 mm
AA	1", 25 mm

### Notes:

- 1) All dimensions measured from nominal rough-in (see J as reference).
- 2) Dimensions subject to change without notice.