



Introduction

The Snow Melting Control 654 is designed to operate electric or hydronic equipment to melt snow or ice from any surface including driveways, walkways, patios, business entrances, parking ramps, loading docks, hospital entrances, helipads or car wash bays. The surface temperature for snow melting is controlled automatically to reduce operating energy costs. The 654 has an automatic start and stop function when used with the Snow/Ice Sensor 090 or 094. Automatic start with a timed stop is available when used with the Snow Sensor 095. The 654 can operate a dedicated hydronic boiler or a mixing device. Isolation relays are required to operate line voltage pumps. Electric systems require a separate GFCI and electrical relay contactor.



Features

- Automatic Snow / Ice Detection
- Supports Both Inslab & Retrofit Aerial Sensors
- Manual Start With Timer
- Programmable Schedule
- tekmarNet® Communication Compatible
- Warm Weather Shut Down
- Cold Weather Cut Out
- Idling
- Snow Melt Zoning With Priority
- Tandem Snow / Ice Detection
- Slab Protection
- Storm
- EconoMelt
- Manual Override
- Snow Melt Zone Tracking
- Scenes
- Away Key
- Exercising
- Alert Output

Table of Contents

Important Safety Information.....	3	Sequence of Operation	25
Installation	4	Snow Melting Overview.....	25
Preparation	4	Slab Temperature Control	25
Physical Dimensions	4	Melt Operation	25
Installation Location.....	4	Melt - Manual Start and Timed Stop	26
Rough-In Wiring.....	4	Melt - Automatic Start and Stop	26
Sizing the Transformer	5	Melt - EconoMelt.....	27
Control Wiring	5	Melt - Automatic Start and Timed Stop	27
Sensor Wiring	7	Melt - Tracked Start and Stop	28
Testing the Sensor Wiring	8	Melt - Scheduled Start and Stop.....	28
Testing the Control Wiring	8	Additional Melting Time	29
Manual Override - Maximum Heat	9	Idle Operation	29
Manual Override - Test.....	9	Storm Operation	29
Manual Override - Purge	9	Warm Weather Shut Down.....	30
Manual Override - Off.....	9	Cold Weather Cut Out	30
Switch Settings.....	9	Away Scene.....	30
User Interface.....	10	Programmable Schedules.....	31
Display	10	Time Clock.....	31
Operation Field.....	10	Snow Melt Zones and Priority	31
Status Field.....	10	Slab Protection	33
Symbols	10	Application Modes.....	33
Programmable Settings.....	11	Electric Operation.....	33
Programming Menus	11	Pulse Width Modulation Operation	33
Access Levels and Access Level Lock	11	Boiler Operation	33
View Menu.....	12	Mixing Operation	35
Set Temp Menu	14	Tandem Snow / Ice Detection	36
Time Menu.....	15	Exercising.....	36
Schedule Menu	16	Alert Relay	36
Display Menu	17	Pump Post Purge.....	36
Scene Menu	17	Melt and Storm Groups	37
Monitor Menu.....	18	User Switch Setup.....	37
Toolbox Menu	19	Troubleshooting.....	38
Override Menu.....	20	Error Messages	38
System Menu.....	21	Frequently Asked Questions	42
Boiler Menu	22	Job Record.....	42
Mix Menu	23	Technical Data.....	44
tekmarNet® Menu	24	Limited Warranty and Product Return Procedure.....	44

Getting Started

Congratulations on the purchase of your new Snow Melting Control!

This manual covers the complete installation, programming and sequence of operation for this control. You will also find instruction on testing, commissioning, and troubleshooting the control and system that it operates.

Important Safety Information

⚠ WARNING



It is your responsibility to ensure that this control is safely installed according to all applicable codes and standards. tekmar is not responsible for damages resulting from improper installation and/or maintenance.

To avoid serious personal injury and damage to the equipment:



- Read Manual and all product labels BEFORE using the equipment. Do not use unless you know the safe and proper operation of this equipment.
- Keep this Manual available for easy access by all users.
- Replacement Manuals are available at tekmarControls.com



- Disconnect all power before opening the control.

- It is the installers responsibility to ensure that this control is safely installed according to all applicable codes and standards.
- Improper installation and operation of this control could result in damage to the equipment and possibly even personal injury or death.
- This electronic control is not intended for use as a primary limit control. Other controls that are intended and certified as safety limits must be placed into the control circuit.
- Do not attempt to service the control. There are no user serviceable parts inside the control. Attempting to do so voids warranty.

Radio Frequency Interference

The installer must ensure that this control and its wiring are isolated and/or shielded from strong sources of electromagnetic noise. Conversely, this Class B digital apparatus complies with Part 15 of the FCC Rules and meets all requirements of the Canadian Interference-Causing Equipment Regulations. However, if this control does cause harmful interference to radio or television reception, which is determined by turning

the control off and on, the user is encouraged to try to correct the interference by re-orientating or relocating the receiving antenna, relocating the receiver with respect to this control, and/or connecting the control to a different circuit from that to which the receiver is connected.

Cet appareil numérique de la classe B respecte toutes les exigences du Règlement sur le matériel brouilleur du Canada.

Sizing the Transformer

The control requires an external transformer. A tekmar Transformer 009 can supply up to 40 VA, and includes an in-line fuse to protect the transformer and control.

The total power capacity of the power supply should be larger than the total load of all the devices connected to the control. This total load must not exceed 100 VA.

Control Wiring

See Application Brochure 654_A for specific application wiring diagrams.

Snow / Ice Sensor

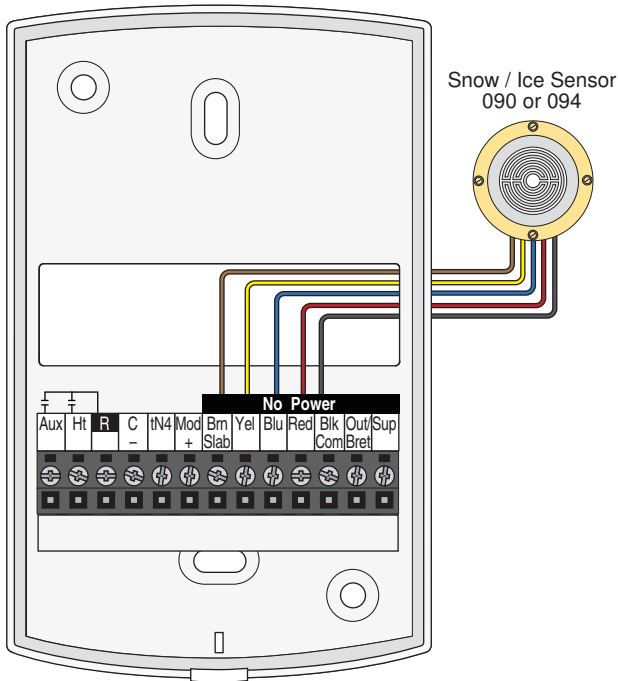

Snow and Slab Sensor

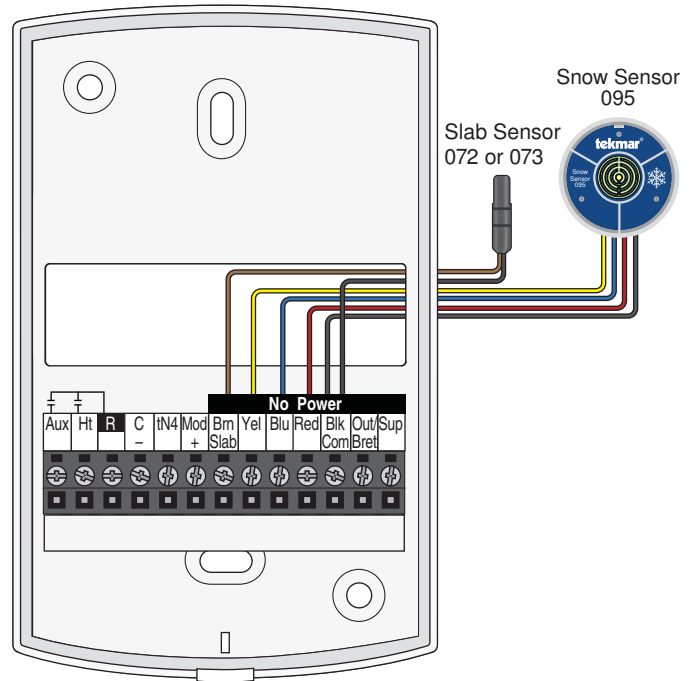

Outdoor, Supply and Boiler Return Sensor

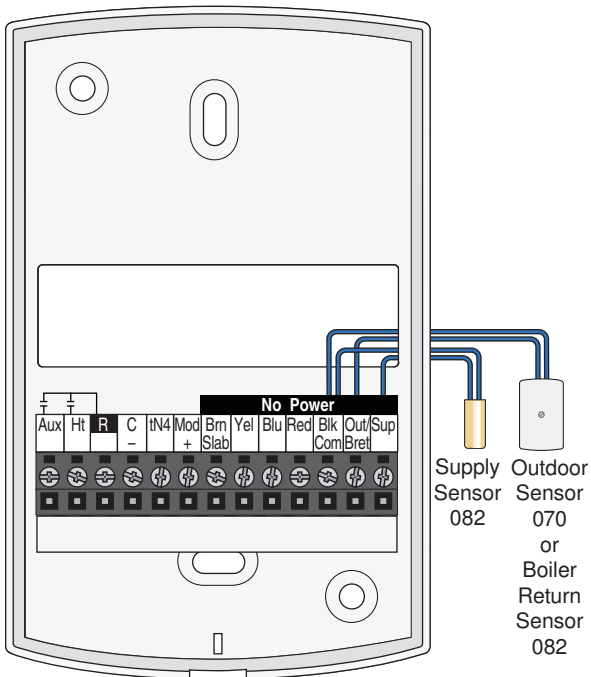

Modulating Output and tN4 Communication

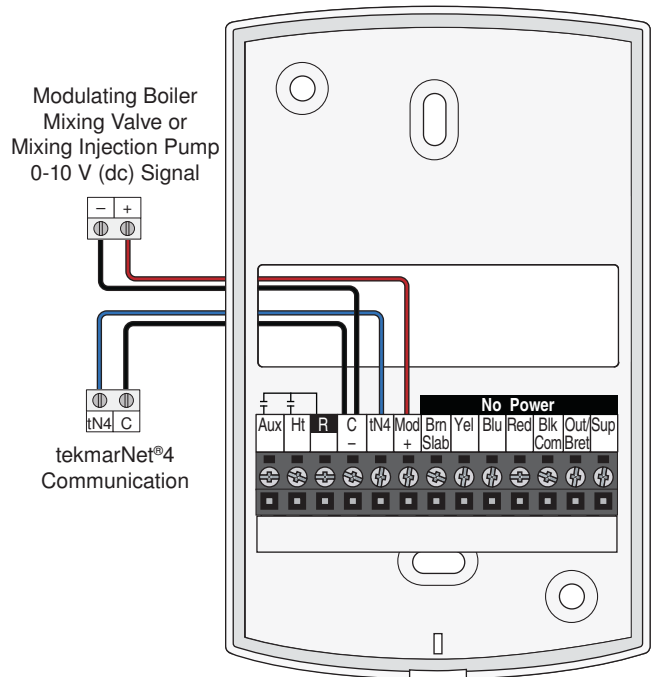

tN4 Wiring Center or Zone Manager

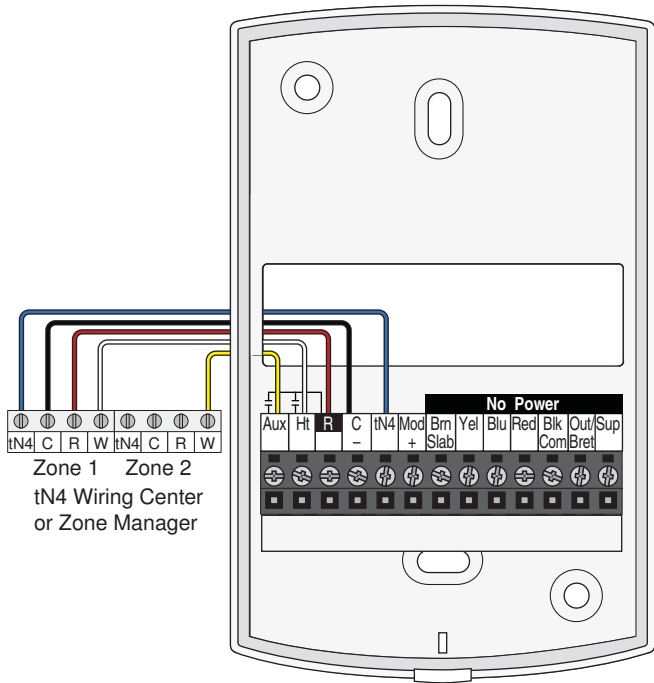

Alert Relay Output

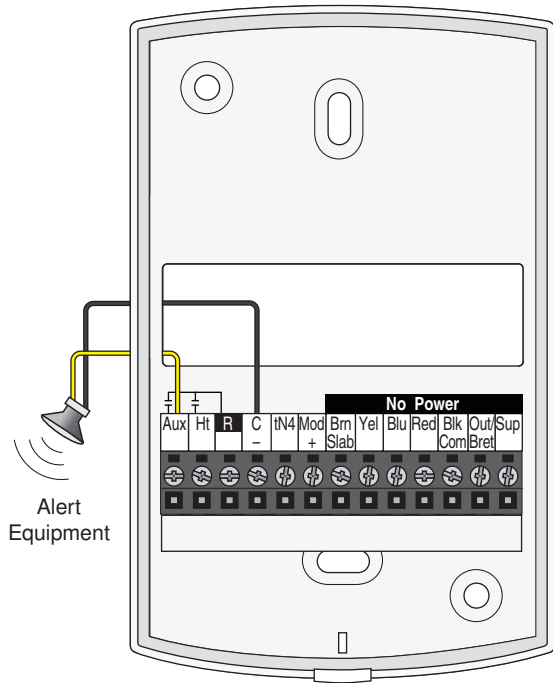

Transformer and Relays

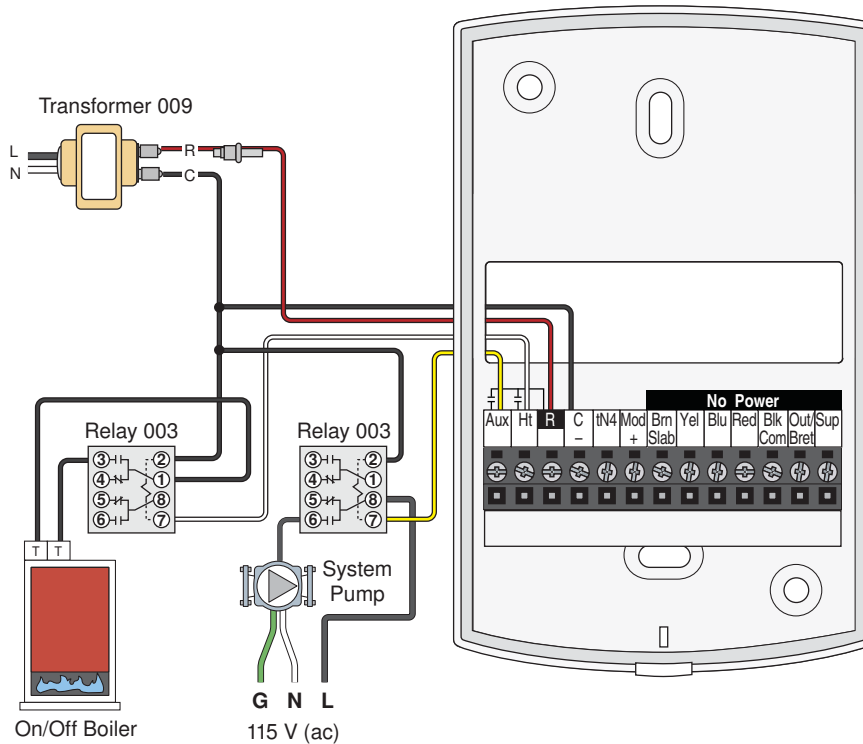

Sensor Wiring

Mounting the Outdoor Sensor

Notice: The temperature sensor (thermistor) is built into the sensor enclosure.

- Remove the screw and pull the front cover off the sensor enclosure.
- The outdoor sensor can either be mounted directly onto a wall or a 2" x 4" electrical box. When the outdoor sensor is wall mounted, the wiring should enter through the back or bottom of the enclosure. Do not mount the outdoor sensor with the conduit knockout facing upwards as rain could enter the enclosure and damage the sensor.

- In order to prevent heat transmitted through the wall from affecting the sensor reading, it may be necessary to install an insulating barrier behind the enclosure.
- The outdoor sensor should be mounted on a wall which best represents the heat load on the building (a northern wall for most buildings and a southern facing wall for buildings with large south facing glass areas). The outdoor sensor should not be exposed to heat sources such as ventilation or window openings.
- The outdoor sensor should be installed at an elevation above the ground that will prevent accidental damage or tampering.

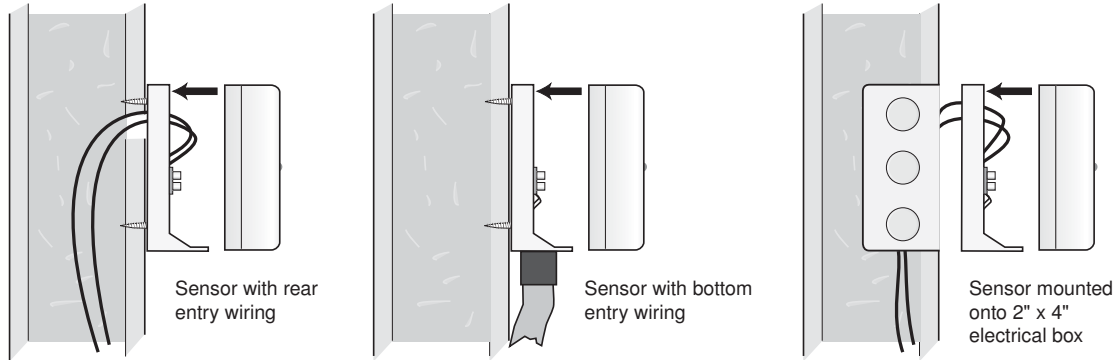

Wiring the Outdoor Sensor

- Connect 18 AWG or similar wire to the two terminals provided in the enclosure and run the wires from the outdoor sensor to the control. Do not run the wires parallel to telephone or power cables. If the sensor wires are located in an area with strong sources of electromagnetic interference (EMI), shielded cable or twisted pair should be used or the wires can be run in a grounded metal conduit. If using shielded cable, the shield wire should be connected to the Com or Com Sen terminal on the control and not to earth ground.
- Follow the sensor testing instructions in this brochure and connect the wires to the control.
- Replace the front cover of the sensor enclosure.

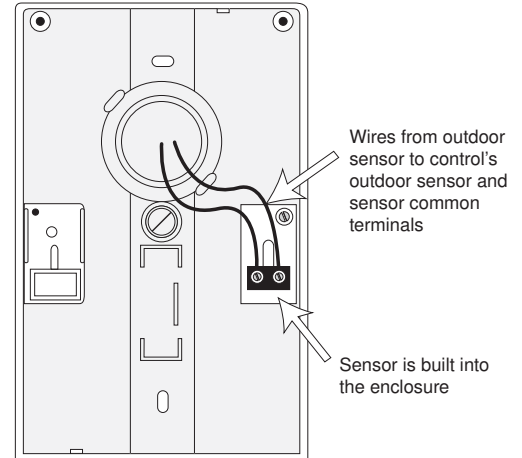

Mounting the Universal Sensor

NOTICE: These sensors are designed to mount on a pipe or in a temperature immersion well.

The Universal Sensor should be placed downstream of a pump or after an elbow or similar fitting. This is especially important if large diameter pipes are used as the thermal stratification within the pipe can result in erroneous sensor readings. Proper sensor location requires that the fluid is thoroughly mixed within the pipe before it reaches the sensor.

Strapped to Pipe

The Universal Sensor can be strapped directly to the pipe using the cable tie provided. Insulation should be placed around the sensor to reduce the effect of air currents on the sensor measurement.

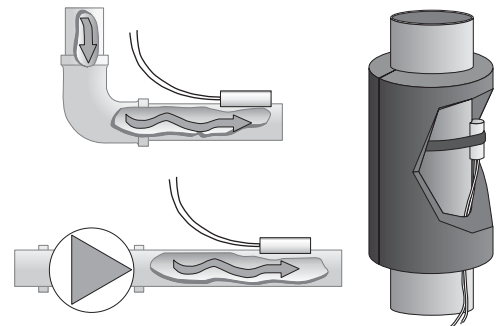

Immersion Well

If a Universal Sensor is mounted onto 1" (25 mm) diameter L type copper pipe, there is approximately an 8 second delay between a sudden change in water temperature and the time the sensor measures the temperature change. This delay increases considerably when mild steel (black iron) pipe is used. In general, it is recommended that a temperature well be used for steel pipe of diameter greater than 1-1/4" (32 mm). Temperature wells are also recommended when large diameter pipes are used and fluid stratification is present.

Conduit Connection

The Universal Sensor and Universal Sensor Enclosure 080 (sold separately) are specifically designed to mount onto a 3/8" (10 mm) ID temperature well that is supplied with an end groove. To install the well, plumb a 'T' into the pipe and fix the well into the 'T'. The 080 enclosure has a 7/8" (22 mm) back knockout that must be removed and fitted over the temperature well. The universal sensor is then inserted into the well and the retaining clip supplied with the enclosure is snapped onto the well end groove. If the well has a threaded end, the installer must supply a standard threaded conduit retaining ring. The two wires from the sensor are connected to the terminal block provided in the enclosure. The other side of the terminal block is used to connect wires from the control.

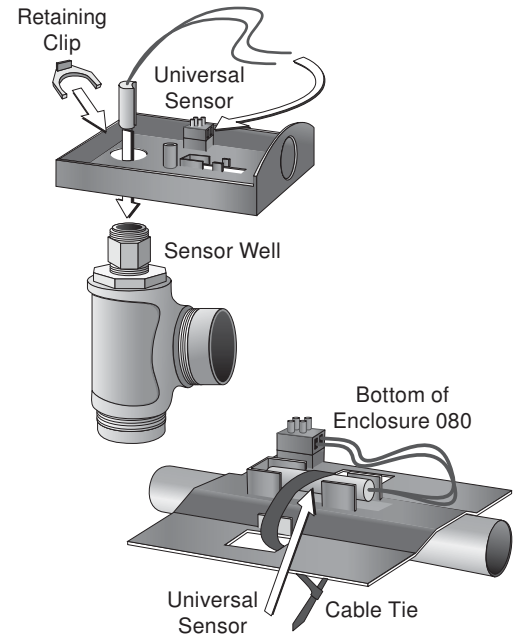

Testing the Sensor Wiring

A good quality test meter capable of measuring up to 5,000 k Ω (1 k Ω = 1000 Ω) is required to measure the sensor resistance. In addition to this, the actual temperature must be measured with either a good quality digital thermometer, or if a thermometer is not available, a second sensor can be placed alongside the one to be tested and the readings compared.

First measure the temperature using the thermometer and then measure the resistance of the sensor at the control. The wires from the sensor must not be connected to the control while the test is performed. Using the chart below, estimate

the temperature measured by the sensor. The sensor and thermometer readings should be close. If the test meter reads a very high resistance, there may be a broken wire, a poor wiring connection or a defective sensor. If the resistance is very low, the wiring may be shorted, there may be moisture in the sensor or the sensor may be defective. To test for a defective sensor, measure the resistance directly at the sensor location.

Do not apply voltage to a sensor at any time as damage to the sensor may result.

Temperature		Resistance	Temperature		Resistance	Temperature		Resistance	Temperature		Resistance
$^{\circ}\text{F}$	$^{\circ}\text{C}$	Ω	$^{\circ}\text{F}$	$^{\circ}\text{C}$	Ω	$^{\circ}\text{F}$	$^{\circ}\text{C}$	Ω	$^{\circ}\text{F}$	$^{\circ}\text{C}$	Ω
-50	-46	490,813	20	-7	46,218	90	32	7,334	160	71	1,689
-45	-43	405,710	25	-4	39,913	95	35	6,532	165	74	1,538
-40	-40	336,606	30	-1	34,558	100	38	5,828	170	77	1,403
-35	-37	280,279	35	2	29,996	105	41	5,210	175	79	1,281
-30	-34	234,196	40	4	26,099	110	43	4,665	180	82	1,172
-25	-32	196,358	45	7	22,763	115	46	4,184	185	85	1,073
-20	-29	165,180	50	10	19,900	120	49	3,760	190	88	983
-15	-26	139,403	55	13	17,436	125	52	3,383	195	91	903
-10	-23	118,018	60	16	15,311	130	54	3,050	200	93	829
-5	-21	100,221	65	18	13,474	135	57	2,754	205	96	763
0	-18	85,362	70	21	11,883	140	60	2,490	210	99	703
5	-15	72,918	75	24	10,501	145	63	2,255	215	102	648
10	-12	62,465	80	27	9,299	150	66	2,045	220	104	598
15	-9	53,658	85	29	8,250	155	68	1,857	225	107	553

Testing the Control Wiring

Testing the Power

1. Remove the front cover from the control.
2. Use an electrical test meter to measure (ac) voltage between the R and C terminals. The reading should be 24 V (ac) \pm 10%.
3. Install the front cover.

Testing the Relay Outputs

The control includes an Override menu to check if the control's relays are operating and that the control is wired correctly to the snow melting equipment.

Step 1: Press and hold the Home button for 3 seconds.

Step 2: Press NEXT to navigate to the Override menu.

Step 3: Press ENTER to enter the Override menu.

Step 4: Select Manual Override to Hand.

Step 5: For hydronic systems, set System Pump to On. The system pump should now be operating.

Step 6: Set Heat Relay to On. The boiler or electric heating cables should start heating.

Step 7: For modulating boilers change the Boiler Percent from 0 to 100%. The boiler should be firing.

Step 8: For a mixing valve or mixing injection pump, change the Mix Percent from 0 to 100%. The mixing valve should open or the mixing injection pump should increase speed.

Step 9: Select the Override Time after which the control resumes normal operation.

Step 10: Exit the Manual Override by selecting Auto.

Manual Override - Maximum Heat

In hydronic application modes, the control includes a Maximum Heat operation where the control operates the snow melting system to maintain the maximum allowed heating setpoints. This allows testing of the snow melting system during warm weather.

Step 1: Press and hold the Home button for 3 seconds.

Step 2: Press NEXT to navigate to the Override menu.

Step 3: Press ENTER to enter the Override menu.

Step 4: Select Manual Override to Max.

Step 5: Select the Maximum Heat Time after which the control resumes normal operation.

Step 6: Exit the Manual Override by selecting Auto.

Manual Override - Test

When operating an electric snow melting system, the control includes a Test operation where the electrical heating cables can be energized for 10 minutes after which the control resumes normal operation. This allows testing of the electric snow melting system during warm weather.

Step 1: Press and hold the Home button for 3 seconds.

Step 2: Press NEXT to navigate to the Override menu.

Step 3: Press ENTER to enter the Override menu.

Step 4: Select Manual Override to Test.

Step 5: Exit the Manual Override by selecting Auto.

Manual Override - Purge

When operating a hydronic snow melting system, it is necessary to purge and bleed all air out of the system. The control includes a Purge operation where the System Pump as well as pumps operated by the tekmarNet® system are all turned on to assist in purging air from the system.

Step 1: Press and hold the Home button for 3 seconds.

Step 2: Press NEXT to navigate to the Override menu.

Step 3: Press ENTER to enter the Override menu.

Step 4: Select Manual Override to Purge.

Step 5: Select the Maximum Purge Time after which the control resumes normal operation.

Step 6: Exit the Manual Override by selecting Auto.

Manual Override - Off

The snow melting system can be manually turned off and the control remains off until manually changed back to Auto. This allows the installer or end user to permanently disable the snow melting system without removing power from the control.

Step 1: Press and hold the Home button for 3 seconds.

Step 2: Press NEXT to navigate to the Override menu.

Step 3: Press ENTER to enter the Override menu.

Step 4: Select Manual Override to Off.

Step 5: Exit the Manual Override by selecting Auto.

Switch Settings



Back of Control

Switch Position Action

Switch	Position	Action
1	ON	LOCK ACCESS LEVEL The control is locally locked and the access level cannot be changed. Set to Lock when installation has been completed.
	OFF	UNLOCK ACCESS LEVEL The control is unlocked and the access level may be changed. Go to the Toolbox menu to change the access level. Set to Unlock during the installation process. Note: tekmarNet® system controls include a Global Lock that locks all connected snow melt controls, and thermostats. Set the tekmarNet® system control to unlock to allow access level adjustment on all connected devices.
2	ON	Not used
	OFF	Not used

User Interface

Display

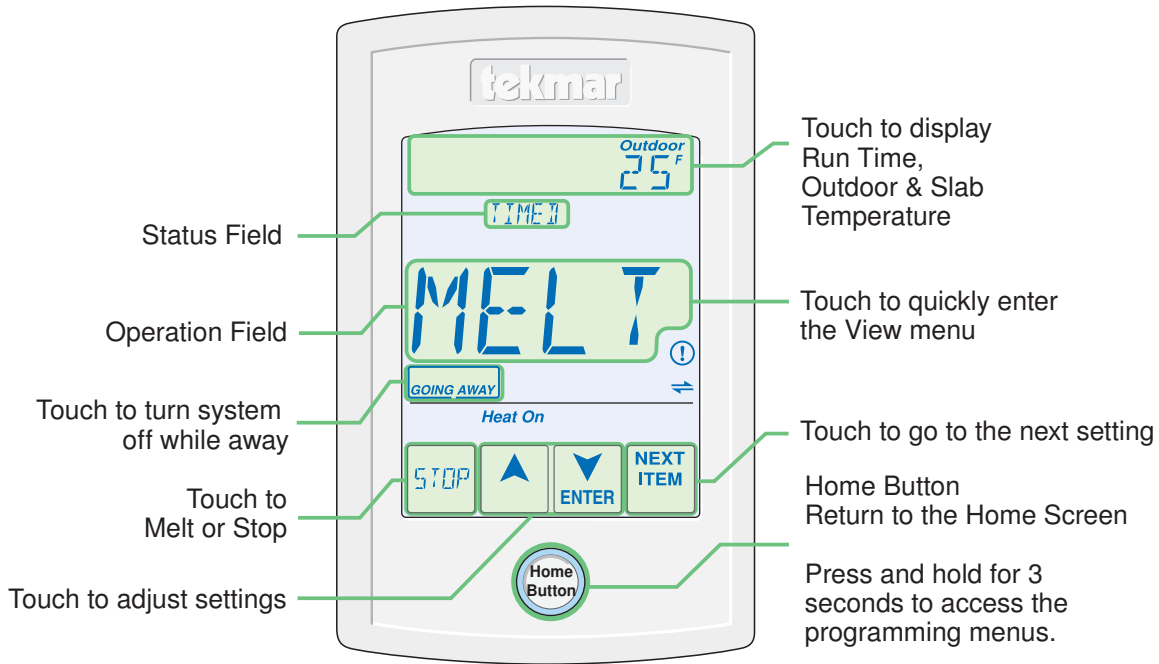

Operation Field

MELT	System is melting snow or ice.	STRM	System is in storm operation.
IDLE	System is idling.	OFF	System is off.

Status Field

WWSD	Warm Weather Shut Down. The slab is naturally warm enough to melt snow or ice.	PEND	Pending. The system has detected water but it is too cold to operate or the schedule is in Idle or Off.
CWCO	Cold Weather Cut Out. Too cold to melt.	WAIT	Zone priority in effect. Zone must wait until higher priority zone finishes melting.
TIMED	Timed melting operation. System operates until time has elapsed.	SENSOR	Tandem 090 sensor.
WARM	Slab is warming up to the melting temperature.	TRACK	This zone tracks the melting operation of zone 1.
AWAY	Away scene. No melting until the away scene is exited.		

Symbols

<i>Heat On</i>	HEAT ON Heat is turned on.		WARNING SYMBOL Indicates an error is present.
	tekmarNet® Communication is present.		ARROWS Adjust the displayed setting.

Programmable Settings

Programming Menus

Press and hold the Home button for 3 seconds to enter the programming menus. The control returns to the last programming menu previously used.

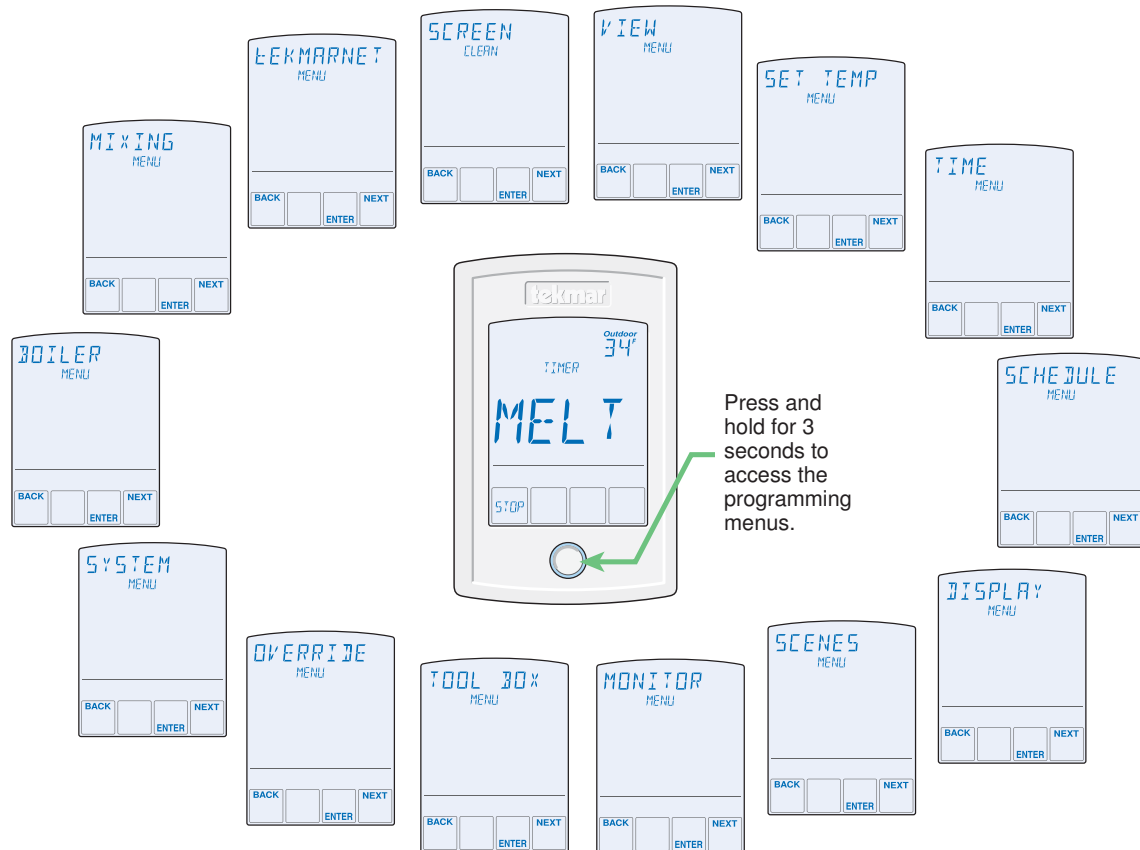

Select a Programming Menu

- Touch “NEXT” to advance (clockwise in above illustration) to the next menu.
- Touch “BACK” to go backwards (counterclockwise in above illustration) through the menus.
- Touch “ENTER” to enter a menu.

Setting Items

- Touch ▲ or ▼ arrow to adjust the setting if required.
- Touch “NEXT ITEM” to advance to the next item within the menu.
- Touch “BACK ITEM” to go backwards to the previous item within the menu.
- To return to the parent menu after changing a setting, press and release the Home button.
- To return to the Home screen, press and release the Home button twice or wait 30 seconds to automatically return to the Home screen.

Access Levels and Access Level Lock

The control is shipped pre-programmed with common settings. The control has an “Installer” access level that allows full access to all settings and a “User” access level that restricts the number of settings available. The control defaults to the “User” access level after 12 hours of operation.

Notice: tekmarNet® system controls include a Global Lock that locks all connected snow melting controls and thermostats. Set the tekmarNet® system control to unlock to allow access level adjustment on all connected devices.

To change to the “Installer” access level:

- In the Toolbox menu, locate Access
- Adjust the access level to “Installer” by pressing the up or down button. This will permit setting changes to the control.

View Menu (1 of 2)

The View menu items display the current operating temperatures and status information of the system.

Item Field	Range	Access	Description	Set to
SNOW ZONE	1 to 12	User Installer	SNOW ZONE The snow melt zone number on the tekmarNet® system. Conditions: tekmarNet® communication available.	
OUTDOOR	---, -76 to 149°F (-60 to 65°C)	User Installer	OUTDOOR Current outdoor air temperature as measured by the local or remote outdoor sensor. The outdoor air temperature is shared to all devices in the tekmarNet® system. "---" is displayed when no outdoor sensor is available. Conditions: Application Mode is set to PWM, Boil, Mix or Elec.	
SLAB TARG	---, -76 to 149°F (-60 to 65°C)	Installer	SLAB TARGET The calculated slab target of the snow melting system. "---" is displayed when the snow melt control is off. Conditions: Application Mode is set to PWM, Boil, Mix or Elec and a snow/ice sensor or slab sensor is installed.	
SLAB	-76 to 149°F (-60 to 65°C)	User Installer	SLAB Current slab temperature as measured by the control. Conditions: Application Mode is set to PWM, Boil, Mix or Elec and a snow/ice sensor or slab sensor is installed.	
SENSOR WATER	DRY or WET	User Installer	WATER SENSOR Current status of the water detection sensor. Conditions: A snow/ice sensor or snow sensor is installed.	
BoilTARGET	---, 70 to 200°F (21.0 to 93.5°C)	Installer	BOILER TARGET The calculated boiler target of the snow melt system. "---" is displayed when the snow melt control is not operating the boiler. Conditions: Application Mode is set to Boil.	
MixTARGET	---, 70 to 200°F (21.0 to 93.5°C)	Installer	MIX TARGET The calculated mix target of the snow melt system. "---" is displayed when the snow melt control is not operating the mixing valve or mixing injection pump. Conditions: Application Mode is set to Mix.	
SUPPLY	-58 to 212°F (50.0 to 100.5°C)	Installer	SUPPLY Current system supply temperature as measured by the control. Conditions: Application Mode is set to PWM, Boil or Mix.	
BoilRETURN	-58 to 212°F (50.0 to 100.5°C)	Installer	BOILER RETURN Current boiler return temperature as measured by the control. Conditions: Application Mode is set to PWM, Boil or Mix and Out/Bret Sensor is set to Bret (boiler return sensor).	
Mix RATE	0 to 100%	Installer	MIX RATE Current position of the mixing valve or mixing injection pump speed. Conditions: Application Mode is set to Mix.	
Boil RATE	0 to 100%	Installer	BOILER RATE Current firing rate of the modulating boiler. Conditions: Application Mode is set to Boil and Boiler Type is set to Mod (modulating boiler).	

View Menu (2 of 2)

Item Field	Range	Access	Description	Set to
HEAT RELAY	OFF or ON	User Installer	HEAT RELAY Current status of the heat relay. The boiler, pump or electric cable is on when ON is displayed. The boiler, pump or electric cable is off when OFF is displayed. Conditions: Application Mode is set to PWM, Boil, Mix, or Elec.	
PWM RATE	0 to 100%	Installer	PWM RATE Current duty cycle rate of the zone or boiler for each 20 minute cycle. Conditions: Application Mode is set to PWM or Elec. Not visible when Manual Override is not Auto.	
SYS PUMP RELAY	OFF or ON	User Installer	SYSTEM PUMP RELAY Current status of the system pump relay. Conditions: Application Mode is set to PWM, Boil or Mix and Auxiliary Relay is set to SYS (system pump).	
ALERT RELAY	OFF or ON	User Installer	ALERT RELAY Current status of the alert relay. Conditions: Application Mode is set to PWM, Boil or Mix and Auxiliary Relay is set to ALRT (alert) or Application Mode is set to Elec.	
MAN MELT HOURS	00:00 to 24:00 hours	User Installer	MANUAL MELT TIME When manually started, the display shows the remaining run time before shutting off. Conditions: Application Mode is set to PWM, Boil, Mix or Elec.	
ADD MELT HOURS	00:00 to 6:00 hours	User Installer	ADDITIONAL MELT TIME When automatically started by a Snow/Ice Sensor 090 or 094, the display shows the remaining run time before shutting off. Conditions: Application Mode is set to PWM, Boil, Mix or Elec and a snow / ice sensor 090 or 094 is installed.	

Set Temp Menu

The Set Temp menu items select the operating temperatures of the snow melt system.

Item Field	Range	Access	Description	Set to
MELTING	32 to 95°F (0.0 to 35.0°C) Default = 36°F (2.0°C)	User Installer	MELTING Select the desired surface temperature of the snow melt surface when melting. Conditions: Application Mode is set to PWM, Boil, Mix or Elec.	
IDLING	OFF, 20 to 95°F (-6.5 to 35.0°C) Default = OFF	Installer	IDLING Select the desired surface temperature of the snow melt surface when idling. Idling pre-heats the slab when the slab is dry but cold and allows faster reaction time to reach the melting temperature. Recommended for commercial use only. Conditions: Application Mode is set to PWM, Boil, Mix or Elec.	
STORM	OFF, 20 to 95°F (-6.5 to 35.0°C) Default = 28°F (-2.0°C)	Installer	STORM Select the desired surface temperature of the snow melt surface while operating in the storm operation. Storm operation temporarily pre-heats the slab to allow faster reaction time to reach the melting temperature. Conditions: Application Mode is set to PWM, Boil, Mix or Elec.	
MAN MELT HOURS	0:30 to 24:00 hours Default = 4:00 hours	User Installer	MANUAL MELT RUN TIME Select the amount of running time when manually starting the system. Conditions: Application Mode is set to PWM, Boil, Mix or Elec.	
ADD MELT HOURS	0:00 to 6:00 hours Default = 0:00 hours	Installer	ADDITIONAL MELT TIME Select the amount of additional melting time after the Snow / Ice Sensor 090 or 094 is dry. This allows low spots on the slab to fully dry before the snow melting system is shut off. Conditions: Conditions: Application Mode is set to PWM, Boil, Mix or Elec and a Snow / Ice Sensor is installed or Track Zone is set to On.	
STORM RUN HOURS	0:30 to 24:00 hours Default = 8:00 hours	Installer	STORM RUN TIME Select the amount of storm run time to pre-heat the slab when advised of a winter storm warning. Conditions: Application Mode is set to PWM, Boil, Mix or Elec and Storm is set to a temperature.	
SENSITIVITY WATER	AUTO, MIN, -2, -1, MID, +1, +2, MAX Default = AUTO	Installer	WATER SENSITIVITY Select how sensitive the Snow / Ice Sensor 090 or 094, or the Snow Sensor 095 is to water detection. Conditions: Snow / Ice Sensor is set to 090 or 095.	
WWSO	AUTO, 32 to 95°F (0.0 to 35.0°C) Default = AUTO	Installer	WARM WEATHER SHUT DOWN Select the temperature at which to shut down the snow melting system during warm weather. This allows the snow or ice to melt off the slab naturally. Conditions: Application Mode is set to PWM, Boil, Mix or Elec.	
CWCO	OFF, -30 to 50°F (-34.5 to 10.0°C) Default = 10°F (-12.0°C)	Installer	COLD WEATHER CUT OUT Select the temperature at which to shut down the snow melting system during extremely cold weather. Below this temperature, the heat loss of the slab exceeds the capacity of the boiler or heating appliance.	

Time Menu







Time settings are only required when using a programmable schedule. The Time menu is not available when the Application Mode is set to 090.

Item Field	Range	Access	Description	Set to
12:00	00 to 59 Default = 00	User Installer	MINUTE Select the current time minutes.	
12:00	12 AM to 11 PM 00 to 23 Default = 12 AM	User Installer	HOURS Select the current time hours.	
SUNDAY	Sunday, Monday, Tuesday, Wednesday, Thursday, Friday, Saturday	User Installer	DAY OF WEEK Select the current day of the week.	
JANUARY 1	JANUARY to DECEMBER	User Installer	MONTH Select the current month. Conditions: Available when Daylight Savings Time is On.	
JANUARY 1	1 to 31 Default = 1	User Installer	DAY OF MONTH Select the day of the current month. Conditions: Available when Daylight Savings Time is On.	
20 13	2006 to 2038 Default = 2013	User Installer	YEAR Select the current year. Conditions: Available when Daylight Savings Time is On.	
DAYLIGHT SAVE	OFF or ON Default = ON	User Installer	DAYLIGHT SAVINGS TIME Select if daylight savings time is observed.	
TIME MODE	12 or 24 hour Default = 12 hour	User Installer	TIME MODE Select either 12 or 24 hour time format.	
CLOCK	OFF or ON Default = OFF	User Installer	CLOCK Select whether or not to show the time clock on the display.	

Schedule Menu

The Schedule menu can operate on a 24 hour or 7 day repeating schedule. When a 24 hour schedule is selected, "SuMoTuWeThFrSa" is shown on the top of the screen to show that the event time applies to all days of the week. When a 7 day schedule is selected, each individual day of the week is shown with the event time.

The Schedule menu is not available when the Application Mode is set to 090.

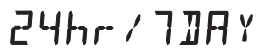
Item Field	Range	Access	Description	Set to
	12:00 AM to 11:50 PM, SKIP or 00:00 to 23:50, SKIP Default = 6:00 AM	User Installer	EVENT 1 The first programmable schedule time period of the day. During Event 1 the control operates in MELT operation.	
	12:00 AM to 11:50 PM, SKIP or 00:00 to 23:50, SKIP Default = 10:00 PM when Event/Day is 2 8:00AM when Event/Day is 4	User Installer	EVENT 2 The first programmable schedule time period of the day. During Event 2 the control operates in OFF or IDLE operation.	
	12:00 AM to 11:50 PM, SKIP or 00:00 to 23:50, SKIP Default = 6:00 PM	User Installer	EVENT 3 The first programmable schedule time period of the day. During Event 3 the control operates in MELT operation.	
	12:00 AM to 11:50 PM, SKIP or 00:00 to 23:50, SKIP Default = 10:00 PM	User Installer	EVENT 4 The first programmable schedule time period of the day. During Event 4 the control operates in OFF or IDLE operation.	
	Always available OFF, ZONE Available with tekmarNet® OFF, ZONE, Master 1, 2, 3, 4, Member 1, 2, 3, 4 Default = OFF	User Installer	SCHEDULE Select if the control should change the temperature automatically using a programmable schedule. OFF = Programmable schedule is not used. Zone = Applies to this control only. Master 1, 2, 3, 4 = In charge of one of four available network schedules. Member 1, 2, 3, 4 = Follows selected network schedule.	
	2 or 4 Default = 2	User Installer	EVENT PER DAY Select the number of temperatures per day.	
	24 hour or 7 day Default = 24 hour	User Installer	24 HOUR / 7 DAY Select between a 24 hour schedule or a 7 days per week schedule.	

Display Menu

The Display menu items select the temperature units and backlight options.

Item Field	Range	Access	Description	Set to
UNITS IN	°F or °C Default = °F	User Installer	UNITS Select Fahrenheit or Celsius as the temperature units.	
BACKLIGHT	ON, ON MELT, OFF Default = ON MELT	User Installer	BACKLIGHT Select how the display backlight operates. ON = Always on. ON MELT = On when melting, off when not melting. This provides a visual indicator to occupants that the snow melting system is currently melting. OFF = Always off.	

Scene Menu

The Scene menu items selects if the away scene and the away key are available. The Scenes menu is not available when the Application Mode is set to 090.

Item Field	Range	Access	Description	Set to
SCENES	NONE or AWAY Default = NONE	User Installer	SCENES Enable or disable the use of scenes (building overrides) on this control.	
AWAY KEY	OFF or ON Default = OFF	User Installer	AWAY KEY Enable or disable the away touch key on the home screen. Condition: Scenes must be set to Away.	

Monitor Menu

The Monitor menu items provide information about the system's operation and performance. The Monitor menu is not available when the Application Mode is set to 090.

Item Field	Range	Access	Description
HEAT HOURS	0 to 9999 hours	User Installer	HEAT HOURS Records the number of running hours since the item was last reset. Touch the number and then the ENTER key to reset to zero.
CYCLES HEAT	0 to 9999 hours	Installer	HEAT CYCLES Records the numbers of cycles of the heat relay since the item was last reset. Touch the number and then the ENTER key to reset to zero.
SYS PUMP HOURS	0 to 9999 hours	User Installer	SYSTEM PUMP HOURS Records the system pump running hours since the item was last reset. Touch the number and then the ENTER key to reset to zero. Conditions: Auxiliary Relay is set to SYS (system pump).
SLAB HIGH	-58 to 167°F (-50.0 to 75.0°C)	Installer	SLAB HIGH Records the highest slab temperature since the item was last reset. Touch the number and then the ENTER key to reset. Conditions: Snow / Ice Sensor is set to 090 or Slab Sensor is set to On.
SLAB LOW	-58 to 167°F (-50.0 to 75.0°C)	Installer	SLAB LOW Records the lowest slab temperature since the item was last reset. Touch the number and then the ENTER key to reset. Conditions: Snow / Ice Sensor is set to 090 or Slab Sensor is set to On.
OUT DOOR HIGH	-58 to 212°F (-50.0 to 100.0°C)	Installer	OUTDOOR HIGH Records the highest outdoor temperature since the item was last reset. Touch the number and then the ENTER key to reset.
OUT DOOR LOW	-58 to 212°F (-50.0 to 100.0°C)	Installer	OUTDOOR LOW Records the lowest outdoor temperature since the item was last reset. Touch the number and then the ENTER key to reset.
SUPPLY HIGH	-58 to 212°F (-50.0 to 100.0°C)	Installer	SUPPLY HIGH Records the highest supply temperature since the item was last reset. Touch the number and then the ENTER key to reset. Conditions: Application Mode is set to PWM, Boil or Mix.
SUPPLY LOW	-58 to 212°F (-50.0 to 100.0°C)	Installer	SUPPLY LOW Records the lowest supply temperature since the item was last reset. Touch the number and then the ENTER key to reset. Conditions: Application Mode is set to PWM, Boil or Mix.
BOILER RETURN HIGH	-58 to 212°F (-50.0 to 100.0°C)	Installer	BOILER RETURN HIGH Records the highest boiler return temperature since the item was last reset. Touch the number and then the ENTER key to reset. Conditions: Application Mode is set to PWM, Boil or Mix and Out/Bret Sensor is set to RET (return).
BOILER RETURN LOW	-58 to 212°F (-50.0 to 100.0°C)	Installer	BOILER RETURN LOW Records the lowest boiler return temperature since the item was last reset. Touch the number and then the ENTER key to reset. Conditions: Application Mode is set to PWM, Boil or Mix and Out/Bret Sensor is set to RET (return).

Toolbox Menu

The Toolbox Menu is a location for system information and Test functions. If any errors are present on the system, they will be located at the beginning of this menu.

Item Field	Range	Access	Description
ACCESS LEVEL	Installer (INST) User (USER) Default = INST	User Installer	ACCESS LEVEL Select the access level of the control, which determines which menus and items are available. Conditions: Adjustable only when control switch setting set to UNLOCK or tekmarNet® system control switch setting set to UNLOCK.
SW J1226A TYPE	Software J1226A Type 654	User Installer	SOFTWARE VERSION AND TYPE NUMBER Select the access level of the control, which determines which menus and items are available.
DEFAULTS LOAD?	Not applicable	Installer	FACTORY DEFAULTS Loads the factory default settings. Press ENTER to load defaults.
HISTORY - 1 -----	See Troubleshooting Guide	Installer	HISTORY - 1 THROUGH 5 Displays a history of any past errors that have occurred on the system. Will clear after 30 days, or press Up and Down buttons for 1 second to manually clear. The last 5 history items will display if present.

Override Menu

The Override Menu allows an operator to manually test each relay and manually start the system.

Item Field	Range	Access	Description
OVERRI DE MANUAL	<p><i>Hydronic</i> AUTO, HAND, MAX, PRGE, OFF</p> <p><i>Electric</i> AUTO, HAND, TEST, OFF</p> <p>Default = AUTO</p>	Installer	<p>MANUAL OVERRIDE Manually override the normal automatic operation of the control to test the equipment or operate the system at the maximum temperature limits. AUTO = Normal operation HAND = Manual override of each relay output MAX = Operate hydronic system at maximum heat TEST = Operate electric system for 10 minutes PRGE = Hydronic system purge operates pumps to help bleed air from the system</p>
SYS PUMP RELAY	<p>OFF or ON Default = OFF</p>	Installer	<p>SYSTEM PUMP RELAY Manually turn on the system pump during the HAND Manual Override.</p>
HEAT RELAY	<p>OFF or ON Default = OFF</p>	Installer	<p>HEAT RELAY Manually turn on the heat during the HAND Manual Override.</p>
PERCENT BOIL	<p>0 to 100% Default = 0%</p>	Installer	<p>BOILER PERCENT Manually set the modulating boiler firing rate during the HAND Manual Override. Conditions: Application Mode is set to Boil.</p>
PERCENT MIX	<p>0 to 100% Default = 0%</p>	Installer	<p>MIX PERCENT Manually set the mixing valve or mixing injection pump output during the HAND Manual Override. Conditions: Application Mode is set to Mix.</p>
ALERT RELAY	<p>OFF or ON Default = OFF</p>	Installer	<p>ALERT RELAY Manually turn on the alert relay during the HAND Manual Override. Conditions: Application Mode is set to PWM, Boil or Mix and Alert Relay is set to ALRT (alert) or the Application Mode is set to Elec.</p>
OVERRI DE HOURS	<p>0:10 to 72:00 hours Default = 0:10 hours</p>	Installer	<p>OVERRI DE TIME Select the amount of time that the HAND Manual Override is in effect before returning to Automatic operation.</p>
MAX PURGE HOURS	<p>0:10 to 72:00 hours Default = 24:00 hours</p>	Installer	<p>MAXIMUM PURGE TIME Select the amount of time that the PURGE Manual Override is in effect before returning to Automatic operation. Conditions: Application Mode is set to PWM, Boil or Mix.</p>
MAX HEAT HOURS	<p>0:10 to 72:00 hours Default = 24:00 hours</p>	Installer	<p>MAXIMUM HEAT TIME Select the amount of time that the MAX HEAT Manual Override is in effect before returning to Automatic operation. Conditions: Application Mode is set to PWM, Boil or Mix.</p>

System Menu

The System Menu provides settings on how to configure and operate the mechanical equipment.

Item Field	Range	Access	Description	Set to
APP MODE	PWM, BOIL, MIX, ELEC, 090 Default = PWM	Installer	APPLICATION MODE Select the control application mode. PWM = Hydronic Pulse Width Modulation. BOIL = Hydronic boiler heats snow melting system. MIX = Hydronic mixing valve or injection pump heats snow melting system. ELEC = Electric snow melt. 090 = Tandem Snow/ Ice Detection using 090 or 094	
SNOW/ICE SENSOR	NONE, 090 (or 094), 095 Default = 090	Installer	SNOW / ICE SENSOR Select if a Snow / Ice Sensor 090 or 094, or Snow Sensor 095 is installed.	
SLAB SENSOR	OFF or ON Default = ON	Installer	SLAB SENSOR Select if a Slab Sensor 072 or 073 is installed to measure the slab temperature. Conditions: Application Mode is set to PWM, Boil or Mix and Snow / Ice Sensor is set to None or 095.	
PROTECT SLAB	OFF or ON Default = ON	Installer	SLAB PROTECTION Select if the slab should be protected from large temperature differentials to avoid cracking the concrete due to high tensile stress. Conditions: Application Mode is set to Boil or Mix and Snow / Ice Sensor is set to 090 or Slab Sensor is set to On.	
OUT/BRET SENSOR	OFF, OUT (Outdoor) or BRET (Boiler Return) Default = OUT	Installer	OUTDOOR OR BOILER RETURN SENSOR Select if the Out/Bret wiring terminal is connected to an outdoor sensor or a boiler return sensor. Conditions: Application Mode is set to PWM, Boil or Mix or Elec.	
ECONOMELT	OFF or ON Default = OFF	Installer	ECONOMELT EconoMelt allows the user to mechanically remove snow then manually start the system to melt the thin snow layer or ice. Conditions: Application Mode is set to PWM, Boil or Mix or Elec.	
tN4 SYS PUMP	OFF or ON Default = ON	Installer	tekmarNet® SYSTEM PUMP Select if the system pump located on the tekmarNet® System Control should operate when the snow melt zone is heating. Conditions: Application Mode is set to PWM, Boil or Mix and Boiler Type is set to CTRL (tN4 control).	
AUXILIARY RELAY	SYS (System Pump) or ALRT (Alert) Default = SYS	Installer	AUXILIARY RELAY Select if the auxiliary relay should function as system pump or as an alert. Conditions: Application Mode is set to PWM, Boil or Mix.	
MAX MELT DAYS	0.5 to 7.0 days, OFF Default = 3.0 days	Installer	MAXIMUM MELT TIME Select to limit the amount of melting run time after snow is automatically detected by a Snow / Ice Sensor 090 or 094, or a Snow Sensor 095. Conditions: Application Mode is set to PWM, Boil or Mix or Elec.	

Boiler Menu

The Boiler Menu provides settings on how to configure and operate the boiler.

Item Field	Range	Access	Description	Set to
Boil TYPE	<p><i>App Mode = Boil</i> MOD, 1STG, EMS1, EMS2 Default = MOD</p> <p><i>App Mode = Mix</i> OFF, ENBL, CTRL Default = OFF</p> <p><i>App Mode = PWM</i> OFF, CTRL Default = OFF</p>	Installer	<p>BOILER TYPE</p> <p>The type of boiler connected to the control. MOD = Modulating boiler. 1STG = Single one-stage on-off boiler. EMS1 = tekmar boiler staging controls. EMS2 = Viessmann modulating boilers with 0-10 V OpenTherm Module. CTRL = tekmarNet® System Control operates boiler. ENBL = When operating a mixing valve or mixing injection pump, the heat relay is closed to fire the boiler.</p>	
MOD TYPE	<p>0-10 or 4-20 Default = 0-10</p>	Installer	<p>BOILER MODULATION TYPE</p> <p>Select if the modulating boiler accepts a 0-10 V (dc) or 4-20 mA input signal to control the boiler firing rate. Conditions: Boiler Type is set to MOD (modulating boiler).</p>	
MIN MOD	<p>0 to 50% Default = 0%</p>	Installer	<p>BOILER MINIMUM MODULATION</p> <p>The minimum percent modulation of the boiler burner. Conditions: Boiler Type is set to MOD (modulating boiler).</p>	
MOD DELAY SEC	<p>OFF, 10 to 180 seconds Default = OFF</p>	Installer	<p>BOILER MODULATION DELAY</p> <p>Delay time between the burner firing and the boiler releasing to modulation. Conditions: Boiler Type is set to MOD (modulating boiler).</p>	
MOTOR SPD SEC	<p>30 to 230 seconds Default = 30 seconds</p>	Installer	<p>BOILER MOTOR SPEED</p> <p>The time required for the modulating actuating motor to fully open the gas valve or ramp the burner fan from off to full speed on a modulating boiler. Set to 30 seconds unless otherwise recommended by the boiler manufacturer. Conditions: Boiler Type is set to MOD (modulating boiler).</p>	
Boil DIFF	<p>AUTO, 2 to 42°F (1.0 to 23.5°C) Default = AUTO</p>	Installer	<p>BOILER DIFFERENTIAL</p> <p>The temperature differential that the control is to use to cycle the boiler on and off (half above and half below target). Conditions: Boiler Type is set to MOD (modulating boiler) or 1STG (one stage).</p>	
Boil MIN	<p>OFF, 50 to 180°F (10.0 to 82.0°C) Default = OFF</p>	Installer	<p>BOILER MINIMUM</p> <p>The minimum allowed boiler target temperature and boiler return protection temperature. Check the boiler manufacturer's manual for recommended supply water temperatures. Conditions: Application Mode is set to Boil or Application Mode is set to Mix and the Boiler Type is set to CTRL (tN4 Control) and Out/Bret Sensor is set to RET (return).</p>	

Mix Menu

The Mix Menu provides settings on how to configure and operate the mixing valve or mixing injection pump. The Mix menu is only available when the Application Mode is set to Mix.

Item Field	Range	Access	Description	Set to
MIX TYPE	0-10 or 4-20 Default = 0-10	Installer	MIX TYPE Select the type of mixing analog signal. 0-10 = 0 to 10 V (dc) 4-20 = 4 to 20 mA	
MOTOR SPD SEC	30 to 230 seconds Default = 105 seconds	Installer	MIX MOTOR SPEED The time that the mix actuating motor requires to operate from fully closed to fully open. Mixing Injection Pump = 30 seconds tekmar Actuator Motor 741 = 105 seconds Refer to actuating motor for correct setting.	
MIX MAX	80 to 180°F (26.5°C to 82.0°C), OFF Default = 140°F (60°C)	Installer	MIX MAXIMUM Select the maximum operating temperature of the system supply water.	

tekmarNet® Menu

The tekmarNet® menu includes settings of how the snow melting control communicates and operates together with other controls. The tekmarNet® menu is only available when communication is detected.

Item Field	Range	Access	Description	Set to
ADDRESS	Range: AUTO, 01 to 24, b:01 to b:24, 1:01 to 1:24, 2:01 to 2:24, 3:01 to 3:24	Installer	ADDRESS The tekmarNet® address of this control. To manually set the address, use the up or down arrow buttons.	
DEVICE COUNT	1 to 24	Installer	DEVICE COUNT Provides a count of all the tekmarNet® thermostats, setpoint controls and snow melting controls on the tekmarNet® system.	
SNOW ZONE	1 to 12 Default = 1	Installer	SNOW ZONE Select the Snow Zone that this control operates. Snow Zone 1 has the highest priority while Snow Zone 12 has the lowest priority.	
TRACK ZONE	OFF or ON Default = OFF	Installer	TRACK ZONE Select to track and record the running hours of Snow Zone 1 and repeats this run time on this control. This allows snow zones without a snow / ice sensor to automatically start. Conditions: Snow Zone must be set 2 through 12 (cannot be Snow Zone 1) and Application Mode is set to PWM, Boil, Mix or Elec.	
MELT GROUP	1 to 12 Default = 1	Installer	MELT GROUP A User Switch may be used to manually start melting the snow zone. Set the Melt Group number to the corresponding Setpoint Enable number on the User Switch. Conditions: Application Mode is set to PWM, Boil, Mix or Elec.	
STORM GROUP	1 to 12 Default = 12	Installer	STORM GROUP A User Switch may be used to manually start storm operation of the snow zone. Set the Melt Group number to the corresponding Setpoint Enable number on the User Switch. Conditions: Application Mode is set to PWM, Boil, Mix or Elec.	
PRIORITY	OFF, COND, FULL Default = OFF	Installer	PRIORITY Select the priority operation of the snow melting system. Conditions: Application Mode is PWM, Mix or Elec.	
LOCAL NET GROUP	OFF or ON Default = OFF	Installer	LOCAL NETWORK GROUP Select if scenes and time clock are shared when connected to a tekmarNet® system. OFF = Send and receive messages. ON = Receive messages only. Conditions: Application Mode is set to PWM, Boil, Mix or Elec.	

Sequence of Operation

Snow Melting Overview

A snow melting system can offer a safe, convenient, and cost effective way of removing snow and ice from the snow melting slab and similar surfaces. Safety is increased by activating the snow melting system as soon as the snow falls rather than waiting for mechanical snow removal after snow has accumulated. This eliminates slip hazards and reduces the risk of injury by mechanized snow melting equipment, thereby reducing potential liability costs. The elimination of snow plow equipment and corrosive salts also reduces damage to the slab surface and to the environment. Snow melting systems when controlled correctly can be cost competitive compared to mechanical snow removal.

The snow melting control can operate in one of four different ways:

- Melt** Heats the slab to melt snow or ice
- Idle** Pre-heats the slab just below freezing to shorten the time required to melt snow
- Storm** Temporarily pre-heats the slab just below freezing to shorten the time required to melt snow
- Off** Snow melting system is off

The control display shows the control operation in the home screen.

Slab Temperature Control

Controlling the slab temperature is critical to minimizing the cost of snow melting. This requires that either a Snow / Ice Sensor 090 or 094 or a Slab Sensor 072 or 073 is installed. The Snow / Ice Sensor contains a built-in slab temperature sensor. While the control will continue to operate without a slab sensor installed, operating costs will be much higher.

The slab is operated using slab outdoor reset. As the outdoor temperature gets colder, the heat loss of the slab increases. In order to keep the slab surface at a constant temperature while operating, the inner core of the slab must be heated above the melt, idle or storm temperature setting. The amount that the slab inner core temperature is above the melt, idle or storm setting is proportional to the outdoor temperature. Since the slab sensor is installed below the surface of the slab, it is not measuring the true slab surface temperature but rather the inner core temperature. The control automatically compensates for this temperature difference. However, the

Slab item in the View menu displays the actual measured temperature, so it is normal to view slab temperatures that exceed the melt, idle, or storm temperature settings.

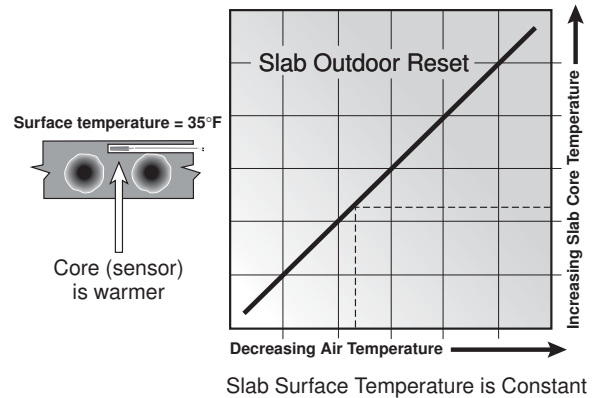

Melt Operation

The snow melting system operates the heating equipment to heat the slab from a cold start or from the idle or storm temperature to reach the melt temperature setting to melt snow or ice. Melt operation can be triggered automatically using a snow / ice sensor, by tracking the run time of another zone, manually by pressing a button, or by a

programmable schedule. The melt temperature setting affects calculated targets such as the slab target, boiler target and mix target.

Melt - Manual Start and Timed Stop

The snow melting system can be started manually in one of three different methods:

- Touch the Melt key on the control display.
- Press the Setpoint Enable button on a User Switch.
- Activate through a Gateway webpage or home automation system.

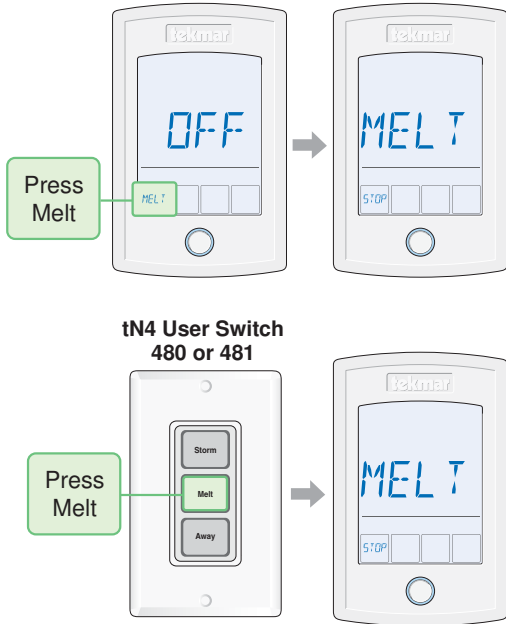

Once manually started, the snow melting system continues to operate until the time set by the Manual Melt Run Time setting in the Set Temp menu elapses.

If a manual start has been provided and a Snow / Ice Sensor detects water, the control changes from manual melt to automatic operation. The snow melting system will continue to operate until the sensor is dry and the Additional Melt Time elapses.

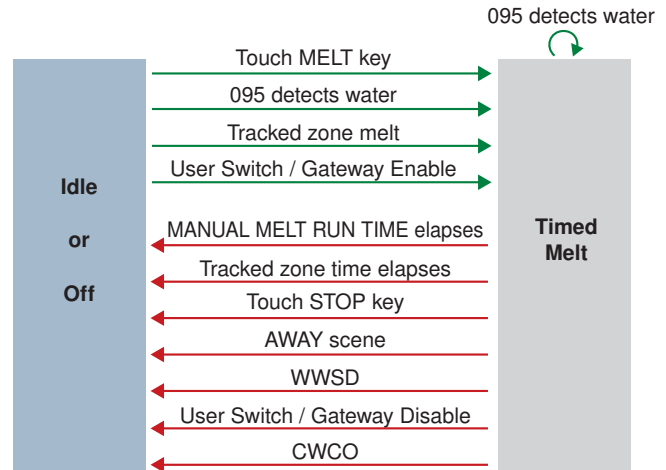

Melt - Automatic Start and Stop

Automatic start and stop operation requires the installation of a Snow / Ice Sensor 090 (65' or 20 m cable) or 094 (210' or 64 m cable). The control continually monitors the sensor for the presence of moisture and slab temperature conditions in which snow or ice may be present. When moisture is detected, the control will show "Sensor Water Wet" in the View menu. When the sensor is dry the control will show "Sensor Water Dry". The control includes a Sensitivity setting in the Set Temp menu that allows the installer to adjust the amount of moisture required to start and stop the melting operation. In areas with low amounts of dust and / or air pollution, the sensitivity may need to be increased. The Sensitivity setting default is Auto, and the control will automatically determine the best suitable sensitivity setting for the installation.



When moisture is detected and the slab and outdoor temperatures are at or below freezing, the control will automatically start the snow melting system. As the snow or ice melts and the slab dries off, the sensor also dries off at the same time. When the sensor is dry, the snow melt system automatically shuts off. If there are low spots on the slab surface that dry off slower than the sensor, additional melting run time can be included by adjusting the Additional Melt Time setting in the Set Temp menu.

If the snow melting system is manually stopped, the Snow / Ice Sensor must fully dry before it is able to detect a new snow fall and automatically start the snow melting system.

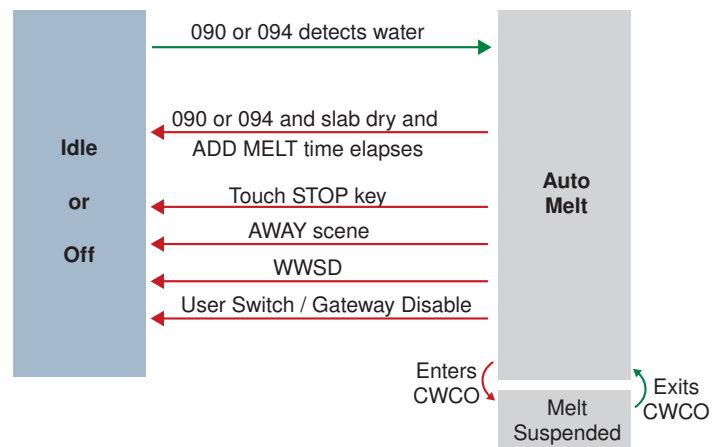

Melt - EconoMelt

When a Snow / Ice Sensor 090 or 094 is installed, the installer can choose to select to either automatically or manually start the snow melting system. Selecting EconoMelt to On provides the option to remove the snow using a snow plow or shovel and then use the snow melting system to melt the remaining thin layer of snow or ice that mechanical snow removal methods are unable to remove. The snow melting system stops when the sensor is dry. The factory default for EconoMelt is Off.

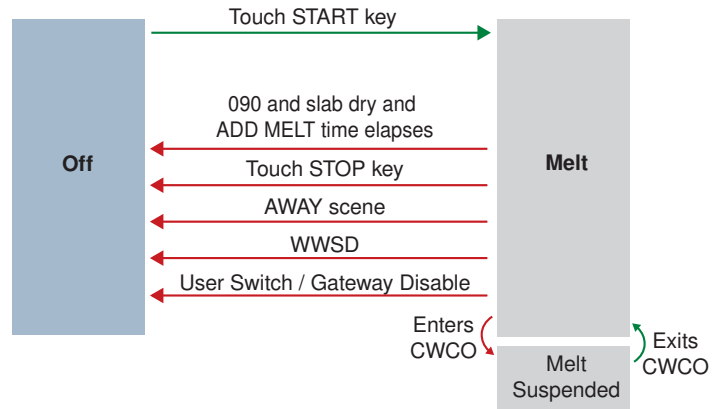

Melt - Automatic Start and Timed Stop

Automatic start with a timed stop operation requires the installation of a Snow Sensor 095. It is also highly recommended to install a Slab Sensor 072 (20' or 6 m cable) or 073 (40' or 12 m cable) in order to regulate the slab temperature and operate the snow melting system at the highest possible efficiency. The control continually monitors the sensor for the presence of moisture and slab temperature conditions in which snow or ice may be present. When moisture is detected, the control will show "Sensor Water Wet" in the View menu. When the sensor is dry the control will show "Sensor Water Dry". The control includes a Sensitivity setting in the Set Temp menu that allows the installer to adjust the amount of moisture required to start

and stop the melting operation. In areas with low amounts of dust and / or air pollution, the sensitivity may need to be increased. The factory default is for the Sensitivity setting is Auto. The control automatically determines the best suitable sensitivity setting for the installation.

When moisture is detected and both the slab and outdoor temperatures are below the Melting setting, the control automatically starts the snow melting system. The snow melting system operates to heat the slab to the slab target temperature and continues to operate until the time set by the Manual Melt Run Time in the Set Temp menu elapses.



Snow Sensor 095

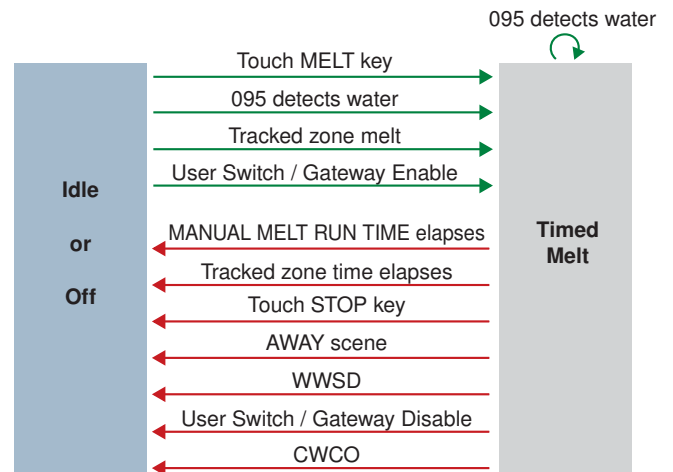

Melt - Tracked Start and Stop

The snow melting system can have multiple zones. Zones have the option to track the melting run time of zone 1. This is useful in cases where zone 1 has an automatic Snow / Ice Sensor installed and the remaining zones do not. This allows zones 2 to 12 to gain the functionality of automatic starting and stopping with only one Snow / Ice sensor installed in the system.

When zone 1 detects snow or ice, it starts melting. Zones with tracking enabled can also start melting unless priority is selected. When the sensor in zone 1 is dry or the Manual Melt Run Time has fully elapsed, it sends a signal to the tracked zones that zone 1 has stopped. Each zone can continue to operate to complete their own Additional Melt Time after which the zone stops heating and returns to the Off or Idle operation. Zones with priority selected start after zone 1 has finished melting and repeat the same run time as zone 1.

Track Melt Start and Stop

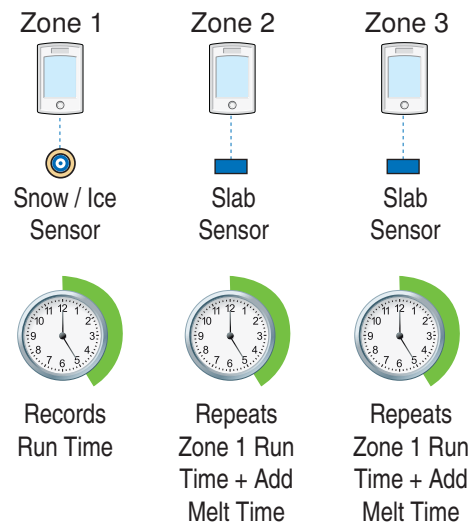

Melt - Scheduled Start and Stop

The snow melting system can be started based upon a programmable schedule. The time clock must cross past the scheduled event time in order to start or stop. In addition, operation is dependent on whether or not a slab sensor, snow / ice, snow sensor or no slab sensor is installed.

The use of a programmable schedule is well suited for commercial installations where operation is not required 24 hours a day.

Systems With Automatic Detection

This applies when a Snow / Ice Sensor 090, 094 or Snow Sensor 095 is installed.

When the time clock reaches the schedule Event 1 (wake) time, the system is allowed to melt if the sensor detects snow or ice.

When the time clock reaches the schedule Event 2 (unoccupied) time, the system is off or in idle operation.

When the time clock reaches the schedule Event 3 (occupied) time, the system is allowed to melt if the sensor detects snow or ice.

When the time clock reaches the schedule Event 4 (sleep) time, the system is off or in idle operation.

Systems Without Automatic Detection

This applies when a Slab Sensor 072, 073 or no slab sensor is installed and there is no automatic detection.

When the time clock reaches the schedule Event 1 (wake) time, the system is in melt operation.

When the time clock reaches the schedule Event 2 (unoccupied) time, the system is off or in idle operation.

When the time clock reaches the schedule Event 3 (occupied) time, the system is in melt operation.

When the time clock reaches the schedule Event 4 (sleep) time, the system is off or in idle operation.

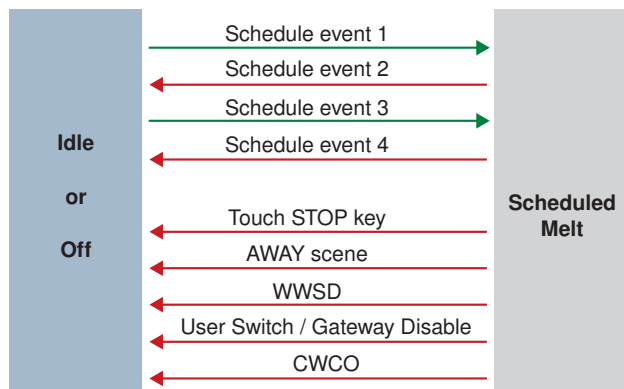

Additional Melting Time

A Snow / Ice Sensor 090 or 094 automatically shuts off the snow melting system when the water sensor is dry. Due to the construction of the slab and the layout of the heating pipe or electrical cable, there may be areas that do not melt completely. The Additional Melt Time setting in the Set Temp menu allows the installer to set addition melting time after the sensor is dry.



Idle Operation

When the snow melting system starts from a cold temperature, there may be a long time delay before the slab is warm enough to melt snow. This time delay allows snow to accumulate on the slab which is not acceptable in some commercial and institutional applications. To decrease the start up time, the slab can be pre-heated to maintain a minimum temperature. This is known as the Idle temperature. Idling requires large energy consumption is generally recommended for institutional and / or commercial installations where safety concerns are paramount. Idle is shown on the display when the control is in idle operation.

When designing a snow melting system, an engineer may specify the amount of allowed snow accumulation as the Snow-Free Area Ratio. There are three different levels. A Snow-Free Area Ratio of 1 is defined as a system that melts all snow as it falls with no allowed accumulation. This requires that the Idle temperature be set just below freezing. Examples of these types of applications include:

- Hospital emergency areas
- Helicopter landing pads
- Parking garage ramps

A Snow-Free Area Ratio of 0.5 is defined as a system with partial snow accumulation on the slab but not in all areas. These types of systems may also use Idling but usually set

at a temperature several degrees below freezing to reduce energy consumption. Applications may include:

- Steep residential driveways
- Commercial sidewalks
- Loading docks

A Snow-Free Area Ratio of 0 is defined as a system that allows snow accumulation. These systems operate the snow melting system from a cold start resulting in the lowest energy consumption costs and the longest times to start melting snow. In this case set the Idle to off. This is recommended for most residential applications:

- Flat residential driveways
- Patios
- Residential sidewalks

Some systems are designed for keeping a slab surface free of ice rather than free of snow. The most common applications include:

- Car wash bays and aprons
- Aircraft hanger aprons
- Turf conditioning on golf course greens

These systems require the use of Idling at or near freezing throughout the winter and may result in high energy consumption.

Storm Operation

For many residential applications it is too costly to Idle the snow melt system all winter. Storm combines the benefits of a fast response time together with lower operating costs. The Storm operation does this by allowing the user to manually pre-heat the slab temporarily in preparation of a snow fall warning. In the event that snow falls and is detected by a Snow / Ice Sensor or a Snow Sensor or the system is manually started, the snow melt system heats the slab up to the melting temperature and completes a melting cycle. Should no snow fall during the storm time period, the control exits Storm operation and returns to Off.

The Storm operation is setup by setting the Storm temperature and the Storm Run Time in the Set Temp menu. The Storm operation can only be activated by a User Switch or Gateway. To respond to a User Switch or Gateway, select the Storm Group number to be 1 through 12. Then program the User Switch or Gateway setpoint enable to be the same as the Storm Group. Pressing the programmed User Switch button will now activate the Storm operation on the snow melting control.

Likewise, sending the setpoint enable command through the Gateway 482 will enable the Storm operation. On the Gateway 483, activating the storm group on the Scenes page in turn enables the Storm operation.

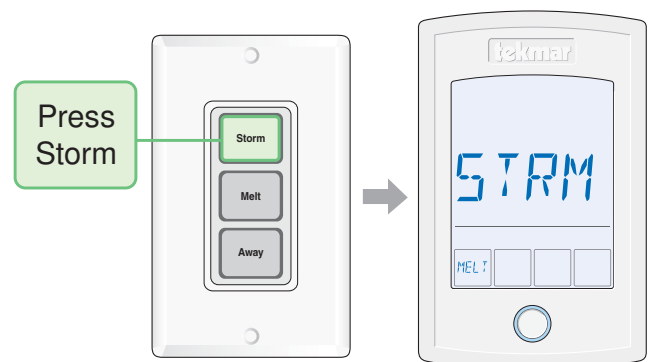

Warm Weather Shut Down

During warm weather, the slab is warm enough to naturally melt snow or ice. The control has a Warm Weather Shut Down (WWSD) setting in the Set Temp menu that prevents the control from entering Melt, Idle or Storm operation in order to conserve energy. The control shows WWSD on the display when WWSD is in effect.

Automatic (Auto)

The control enters WWSD when both the slab temperature of a zone and the outdoor temperature exceed the Melt temperature setting by more than 2°F (1°C).

Manual WWSD

The control enters WWSD when the outdoor air temperature exceeds the WWSD setting by 1°F (0.5°C) and when the slab temperature exceeds 34°F (1°C). The control exits WWSD when the outdoor air temperature falls 1°F (0.5°C) below the WWSD setting or if the slab temperature falls below 34°F (1°C). This allows the Melt temperature setting to be set higher than the WWSD. This is useful when high slab temperatures are required to melt the snow or ice. An example of this are installations using paving bricks on top of sand and concrete layers.

Cold Weather Cut Out

Maintaining the melting or idling temperature during extremely cold temperatures is not only expensive but may be impossible if the heat loss of the slab exceeds the input capacity of the heating plant or electric cable. The control turns the snow melting system off when the outdoor air temperature drops below the Cold Weather Cut Out (CWCO) temperature and the slab is below freezing. This is a safety and energy saving measure. The control shows CWCO on the display

when CWCO is in effect. When the temperature reaches the CWCO setting in an actively melting system with an 090 or 094, melting is suspended until the outdoor temperature rises above the CWCO setting. If an 090 or 094 is not installed, melting is permanently stopped when CWCO is in effect. Melting does not resume when the temperature rises above the CWCO setting.

Away Scene

Scenes provide an easy way to save energy while away on vacation, or override a programmable schedule when plans change.

Away Key

This control includes an Away Key to quickly disable the snow melting system, and when connected to a tekmarNet® system, can also turn down the heating temperature on all thermostats and suspend heating the domestic hot water tank to maximize energy savings. To turn on the Away Key, go to the Scene menu.

To activate the Away scene, touch “Going Away” on the screen.

- Select PERM (permanent) or a number of days using the ▲ or ▼ arrow. Range is 1 to 180 days.
- Press the home button to accept the setting or leave the screen untouched for several seconds.
- “Scene Away” is displayed on the home screen until the number of days expires.
- Touch “Cancel Away” to cancel at any time.

User Switch

A User Switch may be used to activate the Away scene.

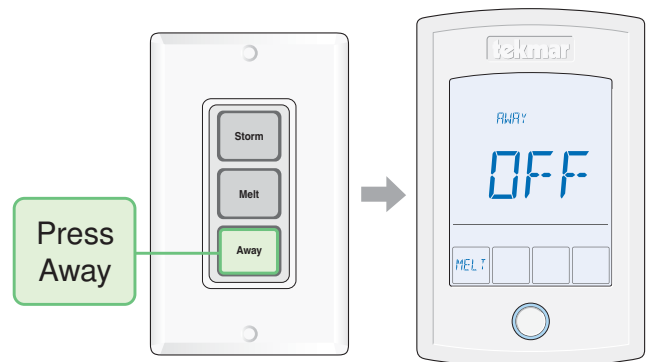
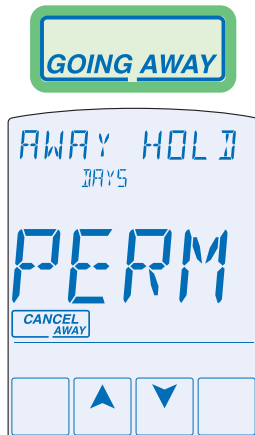

Additional Scenes

The snow melting control supports scenes 1 (normal) 2 (away) and 3 (unoccupied). Scene 3 disables the snow melting system. When the tekmarNet® system is set to scene 4 through 8, the snow melting control remains in scene 1.

Programmable Schedules

To provide greater energy savings, the control can operate on a programmable schedule. The schedule is stored in memory and is not affected by loss of power to the control. If tekmarNet® communication is detected the control can become either a schedule member or schedule master.

Zone Schedule

The schedule only applies to the control. The control follows its own schedule and the events are not communicated to the tekmarNet® system.

Master Schedule

If the control is connected to other tekmarNet® devices, then the control can operate on a master schedule. A maximum of four master schedules are available on the tekmarNet® system. Using master schedules simplify installation since one master schedule may be used by multiple devices.

To create a master schedule:

- Assign the control to be a schedule master by setting Schedule in the Schedule menu to Master (MST) 1 to 4.

To follow a master schedule:

- Assign the control to follow a master schedule by setting Schedule in the Schedule menu to Member (MBR) 1 to 4.

Schedule Types

The schedule type determines when the schedule repeats itself. This control includes two different schedule types:

- 24 Hour: Repeats every 24 hours.
- 7 Day: Repeats on a weekly basis and allows for separate event times for each day.

Events / Day

The events / day can be either 4 or 2. An event is a time at which the control changes the target temperature. The event time can be set to the nearest 10 minutes. To have the control skip the event, enter "SKIP" as the time. SKIP is found between 11:50 PM and 12:00 AM or 23:50 and 00:00 hours.

Time Clock

The control has a built-in time clock to allow the control to operate on a schedule. A battery-less backup allows the control to keep time for up to 4 hours without power. The time

clock supports automatic adjustment for Daylight Saving Time (DST) once the day, month and year are entered. Use the Time menu to set the correct time, day, month and year.

Snow Melt Zones and Priority

Dividing a system into a number of snow melting zones and prioritizing the zone operation reduces the size requirements of the hydronic heating plant or the amperage of the electrical service panel. This results in lower initial capital cost of the snow melting system. The trade off is that some snow melt zones may not be able to melt as soon as the snow fall begins and the user must tolerate snow accumulation on the slab. The snow melt system may have up to 12 snow melt zones. Zone 1 has the highest priority and zone 12 has the lowest. The priority setting in the tekmarNet® menu allows the installer to select the level of zone priority for entire snow melt system. Changing the priority setting on one control will update on all other snow melt controls at the same time.

The zone priority has 3 setting levels. There is some risk that lower priority zones may ice up when they are shut off by the higher priority zone. For example, if a high priority zone should finish melting and allow a lower priority zone to start melting, and then a new snow fall occurs, the high priority zone will shut off the lower priority zones. This may potentially allow the lower priority zones to ice over. The limitations of zoning and using priority must be carefully considered and discussed with the building owners and occupants when designing the snow melting system.

Priority does not apply when the application mode is set to Boiler. In this mode, the boiler is dedicated to a single snow melting zone so priority is no longer applicable.

Hydronic Priority Levels

Priority = None

All zones have the same priority and can operate at the same time.

This setting is recommended when the boiler plant capacity is sized larger than the heat loss of all zones at design conditions.

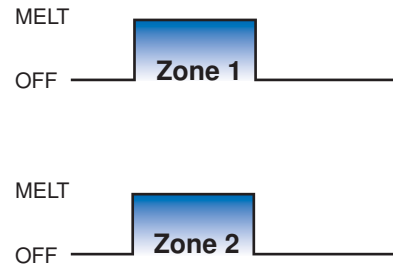

Priority = Conditional

The zone with the lower priority starts melting when the zone with higher priority is warm enough to melt snow or ice.

This setting is recommended when the boiler plant capacity is sized to be larger than the heat loss of each zone with some extra capacity.

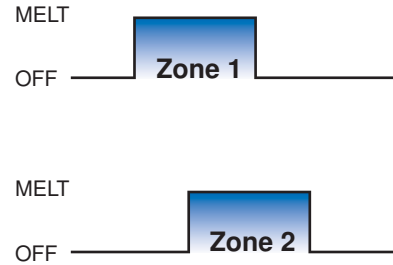

Priority = Full

The zone with the lower priority starts melting once the zone with higher priority has finished melting all snow or ice from the slab.

This setting is recommended when the boiler plant capacity is sized to be the same as the heat loss of each zone at design conditions.

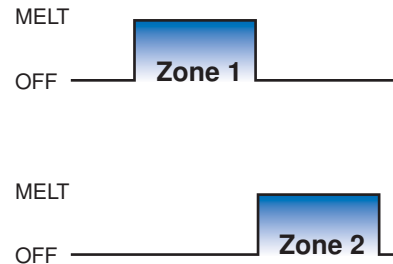

Electric Priority Levels

Electric snow melting offers three levels of priority: None, Conditional and Full. The None and Full priority options function the same as with the hydronic operation. The Conditional priority is unique to electrical operation. The highest priority zone operates first. Whenever the highest priority zone shuts

off its relay, the lower priority zone is allowed to start melting and close its relay. Only one electrical relay is allowed to be on at any time. This eliminates large instantaneous demands and avoids surcharges from the electrical utility.

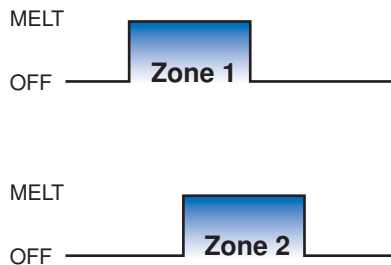

Zone 1 Relay



Zone 2 Relay



Slab Protection

In a hydronic snow melting system, the boiler or heating plant capacity may be much larger than the load of the snow melting zones. This can result in large temperature differentials between the supply water temperature and the slab creating large tensile stresses on the slab. Concrete is weak to tensile forces and when repeatedly exposed to tensile loads the concrete may crack. This may be prevented by selecting the Protect Slab setting in the System menu to On. The control measures and limits the temperature differential between the supply water and the slab.

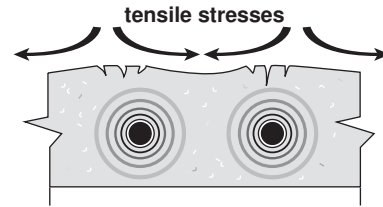

Application Modes

The snow melting control can operate either an electric or a hydronic snow melting system. A hydronic system can be further categorized as either boiler, mixing or pulse width modulation zone operation, as well as, whether the boiler plant is dedicated or non-dedicated for the snow melting system. A dedicated boiler only provides heat from the snow melting system. A non-dedicated boiler provides heat for the snow melting system in addition to the space heating and / or domestic hot water system. The control requires

that one of the following Application Modes is selected in the System menu:

- PWM Pulse Width Modulation
- BOIL Boiler Operation
- MIX Mixing Operation
- ELEC Electrical Operation
- 090 Tandem Snow / Ice Detection using an 090 or 094

Electric Operation

The control operates the heat relay on a 20 minute pulse width modulation cycle. The heat relay in turn activates a line voltage electrical contactor to energize the electrical cable heater installed in the slab. The heat relay on time is determined by the calculated slab target and by the measured slab temperature reading. As the slab temperature reaches the slab target, the on time per cycle of the heat relay is

reduced to prevent the slab temperature from overshooting. If no slab sensor is installed the heat relay remains on 100% of the time until the Melt operation has completed. Idle and Storm operation are not available when a slab sensor is not installed. The electric operation requires the installation of an outdoor sensor. A slab sensor is highly recommended in order to reduce operating costs.

Pulse Width Modulation Operation

The Application Mode should be set to Pulse Width Modulation (PWM) when the boiler or heat source is non-dedicated to the snow melting system and there is no mixing system. The snow melting system is considered to be a zone together with space heating and the domestic hot water system.

The control operates the heat relay on a 20 minute pulse width modulation cycle. The heat relay in turn activates the hydronic heating system zone pump or zone valve. The heat relay on time is determined by the calculated slab target and by the measured slab temperature reading. As the slab temperature reaches the slab target, the on time per cycle of the heat relay

is reduced to prevent the slab temperature from overshooting. If no slab sensor is installed the heat relay remains on 100% of the time until the Melt operation has completed. Idle and Storm operation are not available when a slab sensor is not installed. The hydronic PWM operation requires the installation of an outdoor sensor and a supply sensor. The supply sensor is installed on the glycol antifreeze system supply pipe and allows the control to provide Slab Protection and as well as Supply Zone Priority. A slab sensor is highly recommended in order to reduce operating costs.

Boiler Operation

The Application Mode should be set to Boil when the snow melting system has a dedicated boiler or heat source. The boiler is piped primary-secondary to the snow melting loop, allowing the boiler to fire on and off while allowing continuous flow through the snow melting system loop. The control calculates a Boiler Target based upon the Slab Target which in turn is based upon the measured outdoor temperature and the Melt, Idle or Storm temperature setting. The control can operate a boiler in one of six different methods: modulating boiler, 1 stage, EMS1, EMS2, control and enable. The Boiler

Target is shown in the View menu. Settings for the boiler operation are located in the Boiler menu.

Important Note: The boiler operator, or aquastat, remains in the burner circuit and acts as a secondary upper limit on the boiler temperature. The boiler aquastat temperature setting must be adjusted above 200°F (93.5°C) in order to prevent short cycling of the burner.

Single Stage On/Off Boiler (1STG)

The control turns on or off the heat relay to fire the boiler in order to maintain the Boiler Target temperature. The boiler supply temperature operates on a differential that is half above and half below the boiler target. The status of the boiler is shown by the Boil Relay item in the View menu.

Modulating Boiler (MOD)

The control can operate a single hot-water modulating boiler using the Mod output and the Heat contact. The control operates the boiler by first switching the heat contact to allow the modulating boiler to go through the ignition sequence (the heat contact may not be required on all modulating boilers). A 0-10 V (dc) or 4-20 mA analog signal is then used to modulate the boiler firing rate starting at 50% (5 V (dc) or 12 mA signal) for 30 seconds. After the 30 second delay has elapsed, the control will then allow the boiler to modulate down to the Minimum Modulation setting and hold it there for the Modulation Delay time setting. After the modulation delay has elapsed, the control uses PID logic to change the boiler firing rate signal in order to satisfy the boiler target temperature. When the firing rate signal is reduced down to the minimum modulating setting and the boiler supply temperature exceeds the boiler target by 1/2 of the differential, the control will shut off the boiler burner. The modulating signal output is shown by the Boil Rate item in the View menu.

The Modulation Delay setting is determined by the boiler manufacturer. It is the amount of time that the burner must operate before the internal boiler control allows an external signal to operate the burner.

The Motor Speed sets the rate at which the modulating electrical signal can change. For most modulating boilers with a ECM fan, the motor speed can be set to 30 seconds. For commercial boilers with a mod motor, set the motor speed according to the time required by the mod motor to travel from the closed to open position.

EMS1

The EMS1 signal is a method for the snow melting control to send the boiler target temperature to a tekmar Boiler Control 268. The control provides a 0-10 V (dc) signal proportional to the boiler target and turns on the heat relay to operate the boiler to maintain the Boiler Target temperature.

EMS1 Conversion Table	
0-10 V (dc)	Boiler Target
0	--- (OFF)
1	50°F (10°C)
2	68°F (20°C)
3	86°F (30°C)
4	103°F (39°C)
5	121°F (49°C)
6	139°F (59°C)
7	157°F (69°C)
8	174°F (79°C)
9	192°F (89°C)
10	210°F (99°C)

EMS2

The EMS2 signal is a method for the snow melting control to send the boiler target to a Viessmann boiler that supports the OpenTherm temperature targeting. Typical boilers include the Viessmann Vitodens 100-W and 200-W. The boiler may require an OpenTherm Input Module 0-10V. Contact Viessmann for details. The control provides a 0-10 V (dc) signal proportional to the boiler target and turns on the heat relay to operate the boiler to maintain the Boiler Target temperature.

Control (CTRL)

When the Application Mode is set to Mix or to PWM, the snow melting control can send a call for heat message using tekmarNet® communication to the tN4 System Control. The call for heat is received on the water temperature bus that the snow melting control is communicating on. When wired to a boiler bus, the snow melting control calls for heat on the boiler bus. The same logic applies to the mixing and tank bus available on the tN4 System Control. In most cases, the Boiler Type is set to Control when the snow melting system has a non-dedicated boiler plant.

A tN4 System Control is defined as a control that operates a boiler or mixing system. At the time of this writing the available controls are:

- Boiler Control 274, 275, 284
- House Control 400, 401, 402, 403, 406
- Reset Modules 420, 421, 422, 423

Enable (ENBL)

When the Application Mode is set to Mix, the snow melting system may have a non-dedicated boiler plant. When not using tekmarNet® communication, the heat relay closes whenever the mixing device is increasing and reaches a position or speed of 10%. The heat relay opens when the mixing device is decreasing and reaches a position or speed of 5%.

Mixing Operation

The Application Mode can be set to Mix when a mixing valve or a mixing injection pump is installed to regulate the supply water temperature to the snow melting system. The boiler or heat plant can be either dedicated or non-dedicated to the snow melting system. The mixing device position or speed is controlled by an analog 0-10 V (dc) or a 4-20 mA signal so that the supply temperature maintains the Mix Target temperature. The control calculates a Mix Target based upon the Slab Target which in turn is based upon the measured outdoor temperature and the Melt, Idle or Storm temperature setting. The Mix Maximum setting limits the upper temperature of the Mix Target. The Mix Target is shown in the View menu.

Boiler protection is only available when the snow melting control is connected to a tN4 System Control. The tN4 System Control provides the outdoor temperature to the snow melting control using tekmarNet(R) communication. See Boiler Operation section regarding recommended tN4 System Controls. The mixing device provides boiler return protection to the boiler inlet by closing the valve when the boiler return temperature falls below the Boiler Minimum setting. Boiler return protection requires the installation of a boiler return sensor 082 on the inlet to the boiler and the Outdoor/Boiler Return Sensor setting must be set to Boiler Return.

Mixing Valve and Actuator Motor

The 654 provides a 0-10 V (dc) signal to operate an actuator motor for mixing using a 3 or 4-way mixing valve.

Recommended Mixing Injection Pumps

The control provides a 0-10 V (dc) or 4-20 mA signal to operate a mixing device. In large commercial applications, a Variable Frequency Drive (VFD) that can accept a 0-10 V (dc) or 4-20 mA can be used to vary the speed of the mixing injection pump. For residential and smaller commercial applications, specialized wet rotor, split-capacitor pumps that accept a 0-10 V (dc) signal are available from Grundfos and Taco. See Essay E021 for piping information. The recommended models are listed in the table below.

Flow Rate GPM	Turns open of the Globe Valve	Nominal Pipe Diameter	Taco				Grundfos	
			003-VV	007-VV	0010-VV	0012-VV	UP 15-42 F/VS	UP 26-64 F/VS
1.5 - 2.0	20	1/2"		X			X	
2	100	1/2"	X					
3.0 - 4.5	100	1/2"		X			X	
4 - 5.5	100	3/4"	X					
7.5 - 8.5	100	3/4"		X			X	
12 - 13	100	1"		X			X	
19 - 21	100	1-1/4"			X			X
31 - 32	100	1-1/2"				X		
39 - 42	100	2"				X		

Required Taco 00-VV control settings:

DIP Switch	DIP Switch Position	Description
1	ON	Operates using a linear output characteristic
2	OFF	Automatic operation
3	OFF	Operates using a 0-10 V (dc) signal

Required Grundfos VS control settings:

DIP Switch	DIP Switch Position	Description
A	OFF	Operates using a V (dc) signal
B	OFF	Operates using 0-10 V (dc) range
C	ON	Minimum speed is off
D	ON	Speed control external

Tandem Snow / Ice Detection

In systems where reliability of the snow melting system is critical, it is possible to install two Snow / Ice Sensors 090 or 094 into a single snow melt zone. Both sensors are used to detect snow or ice and if either sensor is wet the snow melting zone starts melting. The zone continues to operate until both sensors are dry. This allows snow or ice detection over a wider area. In the event of a sensor failure, the snow melting zone continues to function normally, giving building maintenance staff time to troubleshoot and replace the sensor if necessary.

In order to setup a zone using tandem snow / ice detection:

- Step 1: Install two Snow Melting Controls 654 each having their own Snow / Ice Sensor 090 or 094.
- Step 2: Connect the two 654 together using tekmarNet® communication.

- Step 3: In the tekmarNet® menu, select the Snow Zone that the 654 is to operate. There can be up to 12 different Snow Zones. Both 654 controls must be set to the same Snow Zone number.
- Step 4: On one of the 654, select the Application Mode to PWM, Boil, Mix or Elec. This control is the Snow Zone Master and it will operate the snow melting equipment.
- Step 5: On the other 654, select the Application Mode to 090. This control is the Snow Zone Member. This control must be wired to power, tekmarNet® communication, and the Snow / Ice Sensor 090 or 094.

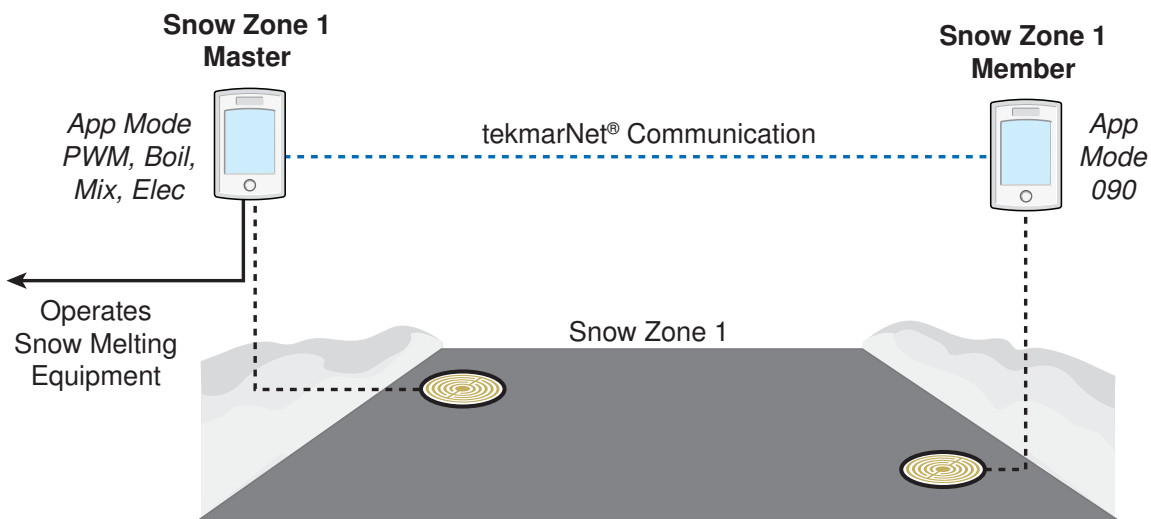

Exercising

In a hydronic snow melting system, the control operates the system pump as well as the mixing valve or mixing injection pump every 3 days to prevent pump and valve seizure.

Alert Relay

The control includes an auxiliary relay that can be configured to be either a system pump or an alert output. When the Auxiliary Relay setting in the System menu is set to Alert, the relay closes whenever there is a local error code. A network error on the tekmarNet® communication system is not considered a local error code and the Alert Relay does not close if only a network error is present. The Alert Relay is connected to the input power R and provides a 24 V (ac) powered signal when closed. An isolation relay may be installed if a dry contact switch is required on the 3rd party equipment.

Pump Post Purge

After a zone has finished heating, the boiler or heat source is shut off and the zone continues to operate for 20 seconds to post purge heat from the boiler to the zone.

Melt and Storm Groups

The snow melting control is able to respond to a setpoint enable signal from a User Switch or Gateway to remotely activate or deactivate the storm or melt operation. The tekmarNet® communication system supports setpoint enable signals 1 through 12. When the snow melting control receives a setpoint enable signal that is the same as the Melt Group number, the control enters Melt operation. Likewise, if the snow melting control receives a setpoint enable signal that is the same as the Storm Group number, the control enters Storm operation. Each snow melting control has its own Melt Group and Storm Group setting located in the tekmarNet® menu.

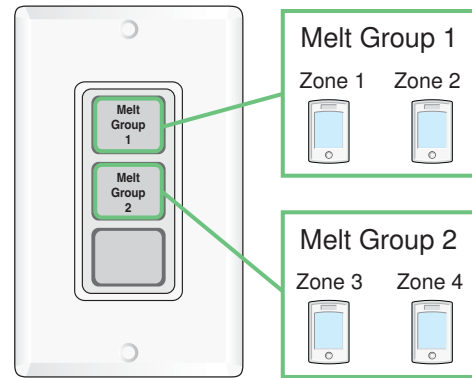

User Switch Setup

A User Switch 480 or 481 can be programmed to allow a user to remotely activate or deactivate the storm, melt, and away operations of the snow melting control. The User Switch has three buttons and it is recommended to have the top button setup to start or stop the Storm operation, the middle button start or stop the Melt operation and the bottom button selects if the scene is Away or Normal.

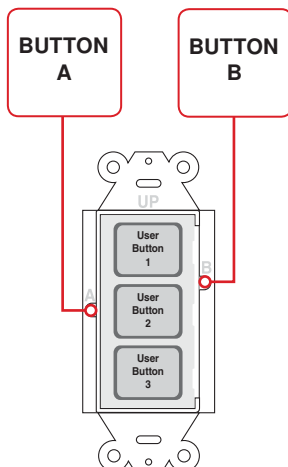
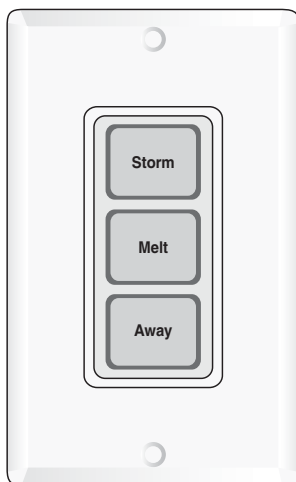

Setup Instructions

The User Switch has a total of 5 buttons.

User Buttons 1, 2, and 3 allow for users to select the operation of the tekmarNet® system.

Buttons A and B allow the installer to program the operation of User Buttons 1, 2, and 3.

The User Switch trim bezel must be removed to program and must be reinstalled after programming is complete.

Storm Button

Step 1: Press button "A" once using a blunt object to begin programming mode.

Step 2: Press and hold the top button until it turns Green, then let go.

Step 3: The snow melting control Storm Group default is 12. Press the User Switch top button 12 times to set the setpoint enable to 12. The button should flash Green 12 times, pause, then repeat the flashing sequence.

Step 4: Press button "B" to finalize the User Button setting and exit the programming mode.

Melt Button

Step 1: Press button "A" once using a blunt object to begin programming mode.

Step 2: Press and hold the middle button until it turns Green, then let go.

Step 3: The snow melting control Melt Group default is 1. Press the User Switch middle button 1 time to set the setpoint enable to 1. The button should flash Green 1 time, pause, then repeat the flashing sequence.

Step 4: Press button "B" to finalize the User Button setting and exit the programming mode.

Away Button

Step 1: Press button "A" once using a blunt object to begin programming mode.

Step 2: Press and hold the top button until it turns Red, then let go.

Step 3: The away scene number is 2. Press the User Switch bottom button 2 times to set the scene number to 2. The button should flash Red 2 times, pause, then repeat the flashing sequence.

Step 4: Press button "B" to finalize the User Button setting and exit the programming mode.

Troubleshooting

It is recommended to complete all wiring to ensure trouble free operation. Should an error occur, simply follow these steps:









- Find:** If the control flashes  on the screen, it is indicating a problem on the system.
- Identify:** Hold the Home button for 3 seconds, touch the NEXT key to locate the Toolbox Menu, then touch the ENTER key. The error code should appear as the first item.
- Solve:** Use the chart below to match the error code to the one on the control. Use the description to solve the problem.

Error Messages (1 of 4)	
Error Message	Description
SET TEMP <small>SAVE</small> ERR	SET TEMP MENU SAVE ERROR The control failed to read the Set Temp menu settings from memory and has reloaded the factory default settings. The control stops operation until all settings in the Set Temp menu are checked. To clear the error, set the access level to Installer and check all settings in the Set Temp menu.
SYSTEM <small>SAVE</small> ERR	SYSTEM MENU SAVE ERROR The control failed to read the System menu settings from memory and has reloaded the factory default settings. The control stops operation until all settings in the System menu are checked. To clear the error, set the access level to Installer and check all settings in the System menu.
BOILER <small>SAVE</small> ERR	BOILER MENU SAVE ERROR The control failed to read the Boiler menu settings from memory and has reloaded the factory default settings. The control stops operation until all settings in the Boiler menu are checked. To clear the error, set the access level to Installer and check all settings in the Boiler menu.
MIXING <small>SAVE</small> ERR	MIXING MENU SAVE ERROR The control failed to read the Mixing menu settings from memory and has reloaded the factory default settings. The control stops operation until all settings in the Mixing menu are checked. To clear the error, set the access level to Installer and check all settings in the Mixing menu.
TEKMARNET <small>SAVE</small> ERR	tekmarNet® MENU SAVE ERROR The control failed to read the tekmarNet® menu settings from memory and has reloaded the factory default settings. The control continues to operate but does not provide any tekmarNet® features until all settings in the tekmarNet® menu are checked. To clear the error, set the access level to Installer and check all settings in the tekmarNet® menu.
SCHEDULE <small>SAVE</small> ERR	SCHEDULE MENU SAVE ERROR The control failed to read the Schedule menu settings from memory and has reloaded the factory default settings. The control operates with the programmable schedule disabled until all settings in the Schedule menu are checked. To clear the error, set the access level to Installer and check all settings in the Schedule menu.
SCENES <small>SAVE</small> ERR	SCENES MENU SAVE ERROR The control failed to read the Scenes menu settings from memory and has reloaded the factory default settings. The control operates with the away scene disabled until all settings in the Scenes menu are checked. To clear the error, set the access level to Installer and check all settings in the Scenes menu.
MAX MELT <small>DAYS</small> ERR	MAXIMUM MELT TIME ERROR The control has operated in melting for the time set by Maximum Melt Days setting located in the System menu. This error is usually created when there is a mechanical system failure resulting in the snow melt slab not heating correctly. Clear the error message by touching the Cancel key while viewing the error message. Use the Manual Override menu to manually check that each component of the mechanical system is operating correctly. If necessary, change the Maximum Melt Days setting to a longer time period or to Off.
TEKMARNET <small>COM</small> ERR	tekmarNet® COMMUNICATION ERROR The tekmarNet® communication bus has either an open or a short circuit. The result is that there are no communications. Check for loose wires between tN4 and C. Check for short circuits between the tN4 and C wires on the House Control, Wiring Center, or Zone Manager. Check for correct polarity between the C and R wires. The error clears automatically once the wiring fault has been corrected. To force the error to clear while allowing a short or open circuit to continue, touch the Cancel key.

Error Messages (2 of 4)

Error Message	Description
<p>ADDRESS TAKEN ERR</p>	<p>ADDRESS TAKEN ERROR Two devices (thermostats, setpoint controls, snow melting controls) have been manually set to the same address. The device continues to operate with this error but does not communicate with the tekmarNet® system. To clear this error, select an unused tekmarNet® address or select automatic addressing.</p>
<p>SNOW ZONE TAKEN ERR</p>	<p>SNOW ZONE TAKEN ERROR Two snow melting controls have been manually set to the same snow zone number and one of the controls is NOT set to App Mode 090. The control continues to operate with this error. To clear this error, select an unused snow zone number or set the App Mode to 090.</p>
<p>APP MODE 090 ERR</p>	<p>APP MODE 090 ERROR Two snow melting controls have been manually set to the same snow zone number and both of the controls are set to App Mode 090. To clear this error, select an unused snow zone number or set the App Mode to anything other than 090.</p>
<p>TANDEM 090 ERR</p>	<p>TANDEM 090 ERROR There are two Snow / Ice Sensors 090 or 094 installed in the zone and the other snow melting control's 090 or 094 has a sensor problem. Locate the other snow melting control and navigate to the Toolbox menu to determine and correct the problem. The control continues to operate with this error.</p>
<p>DEVICE LIMIT ERR</p>	<p>DEVICE LIMIT More than 24 devices (thermostats or setpoint controls) have been connected to the tekmarNet® communication bus. To clear the error, remove and relocate devices to other available buses until the device count is 24 or less.</p>
<p>OUT DOOR SHORT ERR</p>	<p>OUTDOOR SENSOR SHORT CIRCUIT ERROR Due to a short circuit, the control is unable to read the Outdoor Sensor 070. The control continues to operate and assumes an outdoor temperature of 32°F (0°C). Energy saving features such as Warm Weather Shut Down (WWSD) and Cold Weather Cut Out (CWCO) are disabled. Check the outdoor sensor wire for short circuits according to the sensor installation manual. It may be necessary to replace the outdoor sensor. Once the error has been corrected, the error message automatically clears.</p>
<p>OUT DOOR OPEN ERR</p>	<p>OUTDOOR SENSOR OPEN CIRCUIT ERROR Due to an open circuit, the control is unable to read the Outdoor Sensor 070. The control continues to operate and assumes an outdoor temperature of 32°F (0°C). Energy saving features such as Warm Weather Shut Down (WWSD) and Cold Weather Cut Out (CWCO) are disabled. Check the outdoor sensor wire for open circuits according to the sensor installation manual. It may be necessary to replace the outdoor sensor. Once the error has been corrected, the error message automatically clears.</p>
<p>SUPPLY SHORT ERR</p>	<p>SUPPLY SENSOR SHORT CIRCUIT ERROR Due to a short circuit, the control is unable to read the Supply Sensor 082. When set to App Mode Boiler or Mixing the control stops operation and does not provide any heat. When set to App Mode PWM the control continues melting or idling but supply priority operation is not available. Check the supply sensor wire for short circuits according to the sensor installation manual. It may be necessary to replace the supply sensor. Once the error has been corrected, the error message automatically clears.</p>
<p>SUPPLY OPEN ERR</p>	<p>SUPPLY SENSOR OPEN CIRCUIT ERROR Due to an open circuit, the control is unable to read the Supply Sensor 082. When set to App Mode Boiler or Mixing the control stops operation and does not provide any heat. When set to App Mode PWM the control continues melting or idling but supply priority operation is not available. Check the supply sensor wire for open circuits according to the sensor installation manual. It may be necessary to replace the supply sensor. Once the error has been corrected, the error message automatically clears.</p>

Error Messages (3 of 4)

Error Message	Description
 <p>BOILER RETURN SHORT ERR</p>	<p>BOILER RETURN SENSOR SHORT CIRCUIT ERROR</p> <p>Due to a short circuit, the control is unable to read the Boiler Return Sensor 082. The control continues operation but does not provide any boiler return protection.</p> <p>Check the boiler return sensor wire for short circuits according to the sensor installation manual. It may be necessary to replace the boiler return sensor. Once the error has been corrected, the error message automatically clears.</p>
 <p>BOILER RETURN OPEN ERR</p>	<p>BOILER RETURN SENSOR OPEN CIRCUIT ERROR</p> <p>Due to an open circuit, the control is unable to read the Boiler Return Sensor 082. The control continues operation but does not provide any boiler return protection.</p> <p>Check the boiler return sensor wire for open circuits according to the sensor installation manual. It may be necessary to replace the boiler return sensor. Once the error has been corrected, the error message automatically clears.</p>
 <p>SLAB SHORT ERR</p>	<p>SLAB SENSOR SHORT CIRCUIT ERROR</p> <p>Due to a short circuit, the control is unable to read the Slab Sensor 072 or 073. Idling and Storm are disabled and energy saving features such as Warm Weather Shut Down (WWSD) and Cold Weather Cut Out (CWCO) are operate using the outdoor temperature only.</p> <p>Check the slab sensor wire for short circuits according to the sensor installation manual. It may be necessary to replace the slab sensor. Once the error has been corrected, the error message automatically clears.</p>
 <p>SLAB OPEN ERR</p>	<p>SLAB SENSOR OPEN CIRCUIT ERROR</p> <p>Due to an open circuit, the control is unable to read the Slab Sensor 072 or 073. Idling and Storm are disabled and energy saving features such as Warm Weather Shut Down (WWSD) and Cold Weather Cut Out (CWCO) are operate using the outdoor temperature only.</p> <p>Check the slab sensor wire for open circuits according to the sensor installation manual. It may be necessary to replace the slab sensor. Once the error has been corrected, the error message automatically clears.</p> <p>If the slab sensor has been intentionally removed, set the slab sensor setting in the System menu to Off.</p>
 <p>YELLOW OPEN ERR</p>	<p>YELLOW WIRE OPEN CIRCUIT ERROR</p> <p>Due to an open circuit, the control is unable to read the yellow wire connected to the Snow / Ice Sensor 090 or 094, or the Snow Sensor 095. The control can no longer automatically detect snow or ice but manual start of the snow melting system is still available.</p> <p>Check the Snow / Ice Sensor or Snow Sensor yellow and black wires and any wire splices for open circuits according to the sensor installation manual. It may be necessary to replace the sensor. Once the error has been corrected, the error message automatically clears.</p>
 <p>BLUE SHORT ERR</p>	<p>BLUE WIRE SHORT CIRCUIT ERROR</p> <p>Due to a short circuit, the control is unable to read the blue wire connected to the Snow / Ice Sensor 090 or 094, or the Snow Sensor 095. The control can no longer automatically detect snow or ice but manual start of the snow melting system is still available.</p> <p>First check the Snow / Ice Sensor or Snow Sensor for dirt or debris. The ring structure of the sensor may need cleaning with hot soapy water and a nylon brush. Rinse with water. Secondly, check the Snow / Ice Sensor or Snow Sensor blue and black wires and any wire splices for short circuits according to the sensor installation manual. It may be necessary to replace the sensor. Once the error has been corrected, the error message automatically clears.</p>
 <p>BLUE OPEN ERR</p>	<p>BLUE WIRE OPEN CIRCUIT ERROR</p> <p>Due to an open circuit, the control is unable to read the blue wire connected to the Snow / Ice Sensor 090 or 094, or the Snow Sensor 095. The control can no longer automatically detect snow or ice but manual start of the snow melting system is still available.</p> <p>Check the Snow / Ice Sensor or Snow Sensor blue and black wires and any wire splices for open circuits according to the sensor installation manual. It may be necessary to replace the sensor. Once the error has been corrected, the error message automatically clears.</p>
 <p>BROWN OPEN ERR</p>	<p>BROWN WIRE SENSOR OPEN CIRCUIT ERROR</p> <p>Due to an open circuit, the control is unable to read the brown wire connected to the Snow / Ice Sensor 090 or 094. Idling and Storm is disabled and energy saving features such as Warm Weather Shut Down (WWSD) and Cold Weather Cut Out (CWCO) are operate using the outdoor temperature only.</p> <p>Check the Snow / Ice Sensor brown and black wires for open circuits according to the sensor installation manual. It may be necessary to replace the sensor. Once the error has been corrected, the error message automatically clears.</p>

Error Messages (4 of 4)

Error Message	Description
SNOW / ICE <small>SENSOR</small> ERR	SNOW / ICE SENSOR ERROR The control is unable to properly detect the Snow / Ice Sensor 090 or 094. The control can no longer automatically detect snow or ice but manual start of the snow melting system is still available. Check the Snow / Ice Sensor brown, yellow, red and black wires according to the sensor installation manual. It is important to check any cable splices for loose wiring connections. It may be necessary to replace the sensor. Once the error has been corrected, the error message automatically clears.
SNOW <small>SENSOR</small> ERR	SNOW SENSOR ERROR The control is unable to properly detect the Snow Sensor 095. The control can no longer automatically detect snow but manual start of the snow melting system is still available. Check the Snow Sensor yellow, red and black wires according to the sensor installation manual. It may be necessary to replace the sensor. Once the error has been corrected, the error message automatically clears.
SCHEDULE <small>MASTER</small> ERR	SCHEDULE MASTER ERROR Two devices on the tekmarNet® system have been set to the same Schedule Master number. The control operates according to the local programmable schedule while this error is present. To clear the error, select a different Schedule Master number, set a different Schedule Member number, set the Schedule to Zone, or set the Schedule to None.
SCHEDULE <small>MEMBER</small> ERR	SCHEDULE MEMBER ERROR The control can no longer detect its schedule master. The control operates as if the programmable schedule is in idle or off operation while this error is present. To clear the error, select a different Schedule Member number, set the Schedule to Zone, or set the Schedule to None.
ERROR AT <small>TSTAT</small> 01	ERROR AT THERMOSTAT There is an error on a different thermostat or setpoint control connected to the tekmarNet® system and not on this control. 01 to 24 = There is an error on a thermostat or setpoint control with this tekmarNet® address.
ERROR AT <small>TSTAT</small> b:01	ERROR AT THERMOSTAT There is an error on a different thermostat or setpoint control connected to the tekmarNet® system and not on this control. b:01 to b:24 = There is an error on a thermostat or setpoint control wired to the boiler communication bus with this tekmarNet® address.
ERROR AT <small>TSTAT</small> 1:01	ERROR AT THERMOSTAT There is an error on a different thermostat or setpoint control connected to the tekmarNet® system and not on this control. 1:01 to 1:24 = There is an error on a thermostat or setpoint control wired to communication bus 1 with this tekmarNet® address.
ERROR AT <small>TSTAT</small> 2:01	ERROR AT THERMOSTAT There is an error on a different thermostat or setpoint control connected to the tekmarNet® system and not on this control. 2:01 to 2:24 = There is an error on a thermostat or setpoint control wired to communication bus 2 with this tekmarNet® address.
ERROR AT <small>TSTAT</small> 3:01	ERROR AT THERMOSTAT There is an error on a different thermostat or setpoint control connected to the tekmarNet® system and not on this control. 3:01 to 3:24 = There is an error on a thermostat or setpoint control wired to the mix 3 bus with this tekmarNet® address.
ERROR AT <small>SYSTEM</small> CTRL	ERROR AT SYSTEM CONTROL There is an error on the tekmarNet® system control connected to the tekmarNet® system and not on this control.

Frequently Asked Questions

Symptom	Look For...	Corrective Action
LCD display is off	Power to control	Use electrical meter to measure 24 V (ac) voltage on input power R and C terminals.
System pump always on	Display shows Idle	Idle operation requires that the system pump operate continuously while below the melting temperature setting.
Blue short	Dirt or salt on snow/ice sensor	The snow/ice sensor requires regular cleaning. Avoid using road salt on the snow melting slab.
Slab is above melt temperature	Slab Target	The slab is heated to the slab target.
	Heat On not shown	Check wiring of the system pump. The system pump operates continuously during melt, idle or storm operation. The heat source must be wired to operate together with the heat relay.
System running with no snow	Idle	Idling heats the slab when the temperature falls below the Idle temperature.
	Melt	During cold weather cut out (CWCO), the system is shut off. If shut off during a melt cycle, the system resumes melting once the outdoor temperature is above CWCO.
	Timed Melt	System manually started.
	Sched Melt	System started on a programmable schedule.
Snow on slab but system did not start	Off	System has a programmable schedule and is in event 2 or 4 (unoccupied).
	Off	System has been manually Stopped and the automatic snow / ice sensor never dried, thereby preventing the system to automatically start.

Job Record

Schedule Menu Settings

Item	Setting
EVENT 1	
EVENT 2	
EVENT 3	
EVENT 4	

Item	Setting
SCHEDULE	
EVENT PER DAY	
24 HOUR / 7 DAY	

Display Menu Settings

Item	Setting
UNITS	

Item	Setting
BACKLIGHT	

Scene Menu Settings

Item	Setting
SCENES	

Item	Setting
AWAY KEY	

Set Temp Menu Settings

Item	Setting
MELTING	
IDLING	
STORM	
MANUAL MELT RUN TIME	
ADDITIONAL MELT TIME	

Item	Setting
STORM RUN TIME	
WATER SENSITIVITY	
WARM WEATHER SHUT DOWN	
COLD WEATHER CUT OUT	

System Menu Settings

Item	Setting
APPLICATION MODE	
SNOW / ICE SENSOR	
SLAB SENSOR	
SLAB PROTECTION	
OUTDOOR OR BOILER RETURN SENSOR	

Item	Setting
ECONOMELT	
tekmarNet® SYSTEM PUMP	
AUXILIARY RELAY	
MAXIMUM MELT TIME	

Boiler Menu Settings

Item	Setting
BOILER TYPE	
BOILER MODULATION TYPE	
BOILER MINIMUM MODULATION	
BOILER MODULATION DELAY	

Item	Setting
BOILER MOTOR SPEED	
BOILER DIFFERENTIAL	
BOILER MINIMUM	

Mixing Menu Settings

Item	Setting
MIX TYPE	
MIX MOTOR SPEED	

Item	Setting
MIX MAXIMUM	

tekmarNet® Menu Settings

Item	Setting
ADDRESS	
SNOW ZONE	
TRACK ZONE	
MELT GROUP	

Item	Setting
STORM GROUP	
PRIORITY	
LOCAL NETWORK GROUP	

WARNING: This product contains chemicals known to the State of California to cause cancer and birth defects or other reproductive harm. For more information: www.watts.com/prop65

Technical Data

Snow Melting Control 654 tekmarNet® Electric or Hydronic Boiler / Mixing	
Literature	654_A, 654_C, 654_D, 654_Q, 654_U
Control	Microprocessor control. This is not a safety (limit) control
Packaged weight	1.3 lb. (590 g)
Dimensions	5" H x 3-1/4" W x 15/16" D (127 x 82 x 23 mm)
Enclosure	White PVC plastic, NEMA type 1
Ambient conditions	-4 to 122°F (-20 to 50°C), < 90% RH non-condensing, outdoor use permitted when installed inside a NEMA 3 enclosure
Power supply	24 V (ac) ±10%, 60 Hz, Class 2, 16 VA standby, 100 VA fully loaded
Relay capacity	24 V (ac) 2 A, 3.6 A combined
Modulating output	0-10 V (dc), 500 Ω minimum load impedance, 4-20 mA 1 kΩ max load impedance
Sensors	NTC thermistor, 10k Ω @ 77°F (25°C ± 0.2°C) β=3892
- Included	Outdoor Sensor 070 and Universal Sensor 082
- Optional	tekmar type: 071, 072, 073, 082, 090, 091, 094, 095
Warranty	Limited 3 Year

Limited Warranty and Product Return Procedure

Limited Warranty *The liability of tekmar under this warranty is limited. The Purchaser, by taking receipt of any tekmar product ("Product"), acknowledges the terms of the Limited Warranty in effect at the time of such Product sale and acknowledges that it has read and understands same.*

The tekmar Limited Warranty to the Purchaser on the Products sold hereunder is a manufacturer's pass-through warranty which the Purchaser is authorized to pass through to its customers. Under the Limited Warranty, each tekmar Product is warranted against defects in workmanship and materials if the Product is installed and used in compliance with tekmar's instructions, ordinary wear and tear excepted. The pass-through warranty period is for a period of twenty-four (24) months from the production date if the Product is not installed during that period, or twelve (12) months from the documented date of installation if installed within twenty-four (24) months from the production date.

The liability of tekmar under the Limited Warranty shall be limited to, at tekmar's sole discretion: the cost of parts and labor provided by tekmar to repair defects in materials and/or workmanship of the defective product; or to the exchange of the defective product for a warranty replacement product; or to the granting of credit limited to the original cost of the defective product, and such repair, exchange or credit shall be the sole remedy available from tekmar, and, without limiting the foregoing in any way, tekmar is not responsible, in contract, tort or strict product liability, for any other losses, costs, expenses, inconveniences, or damages, whether direct, indirect, special, secondary, incidental or consequential, arising from ownership or use of the product, or from defects in workmanship or materials, including any liability for fundamental breach of contract.

The pass-through Limited Warranty applies only to those defective Products returned to tekmar during the warranty period. This Limited Warranty does not cover the cost of the parts or labor to remove or transport the defective Product, or to reinstall the repaired or replacement Product, all such costs and expenses being subject to Purchaser's agreement and warranty with its customers.

Any representations or warranties about the Products made by Purchaser to its customers which are different from or in excess of the tekmar Limited Warranty are the Purchaser's sole responsibility and obligation. Purchaser shall indemnify and hold tekmar harmless from and against any and all claims, liabilities and damages of any kind or nature which arise out of or are related to any such representations or warranties by Purchaser to its customers.

The pass-through Limited Warranty does not apply if the returned Product has been damaged by negligence by persons other than tekmar, accident, fire, Act of God, abuse or misuse; or has been damaged by modifications, alterations or attachments made subsequent to purchase which have not been authorized by tekmar; or if the Product was not installed in compliance with tekmar's instructions and/or the local codes and ordinances; or if due to defective installation of the Product; or if the Product was not used in compliance with tekmar's instructions.

THIS WARRANTY IS IN LIEU OF ALL OTHER WARRANTIES, EXPRESS OR IMPLIED, WHICH THE GOVERNING LAW ALLOWS PARTIES TO CONTRACTUALLY EXCLUDE, INCLUDING, WITHOUT LIMITATION, IMPLIED WARRANTIES OF MERCHANTABILITY AND FITNESS FOR A PARTICULAR PURPOSE, DURABILITY OR DESCRIPTION OF THE PRODUCT, ITS NON-INFRINGEMENT OF ANY RELEVANT PATENTS OR TRADEMARKS, AND ITS COMPLIANCE WITH OR NON-VIOLATION OF ANY APPLICABLE ENVIRONMENTAL, HEALTH OR SAFETY LEGISLATION; THE TERM OF ANY OTHER WARRANTY NOT HEREBY CONTRACTUALLY EXCLUDED IS LIMITED SUCH THAT IT SHALL NOT EXTEND BEYOND TWENTY-FOUR (24) MONTHS FROM THE PRODUCTION DATE, TO THE EXTENT THAT SUCH LIMITATION IS ALLOWED BY THE GOVERNING LAW.

Product Warranty Return Procedure All Products that are believed to have defects in workmanship or materials must be returned, together with a written description of the defect, to the tekmar Representative assigned to the territory in which such Product is located. If tekmar receives an inquiry from someone other than a tekmar Representative, including an inquiry from Purchaser (if not a tekmar Representative) or Purchaser's customers, regarding a potential warranty claim, tekmar's sole obligation shall be to provide the address and other contact information regarding the appropriate Representative.



tekmar Control Systems Ltd., A Watts Water Technologies Company. Head Office: 5100 Silver Star Road, Vernon, B.C. Canada V1B 3K4, 250-545-7749, Fax. 250-545-0650 Web Site: www.tekmarControls.com