

RP77553▲
Hose & Sprayer Assembly
Ensamble de la manguera
Tuyau souple

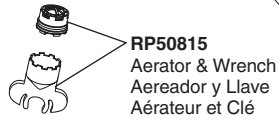

RP50815
Aerator & Wrench
Aereador y Llave
Aérateur et Clé

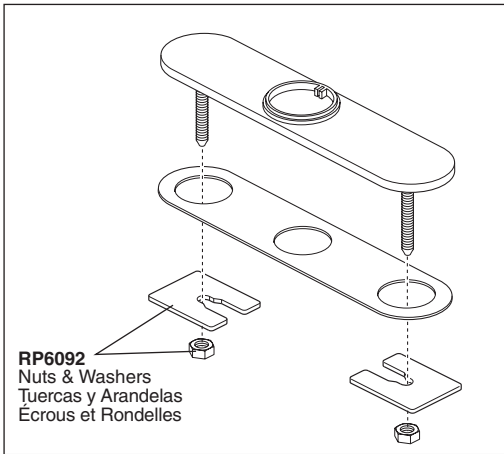

RP6092
Nuts & Washers
Tuercas y Arandelas
Écrous et Rondelles

RP71451▲
Optional 10" Escutcheon with 8" Centers,
Mounting Screws and gasket
Chapa opcional de 10" de 8" centros,
Tornillos para la Instalación y Empaque
Plaque de finition facultative de 10 po pour
8 po centres, vis de montage, écrous, ron-
delles et joint

RP51685
Mounting Bracket
& Nut
Abrazadera para
la Instalación y
Tuerca
Fixation et écrou



RP49149
Steel Weight Assembly
Ensamble de la Pesa
de Acero
Massetotte en acier



RP60911
Clip
Presilla
Agrafe

RP40531
Wrench
Llave
Rondelle

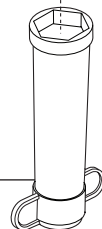

RP51243
Inlet Gaskets
Empaques para el tubo de entrada
Joints côté alimentation

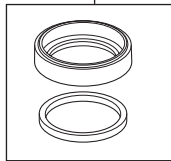

RP77552▲
Trim Ring
and Gasket
Aro de Accesorio
y Empaque
Anneau de finition
et Joint

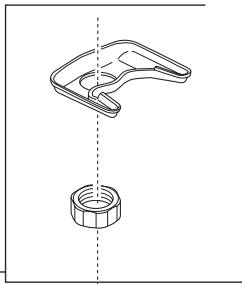

RP77550▲
Handle, Set Screw &
Button
Manija, tornillo de presión
y Botón
Poignée, Vis de calage et
Bouton

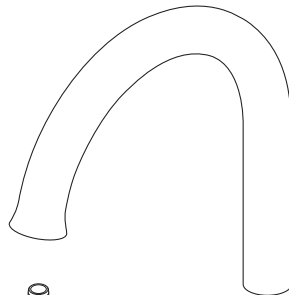

RP77549▲
Kitchen Spout Assembly with Magnet
Ensamble del Tubo de Salida
Bec



RP60923
Friction Spacer
Anillo de la fricción
Boucle de frottement

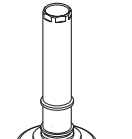

RP73000
Cartridge Assembly
Ensamble de la válvula
Soupape

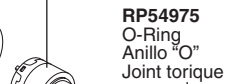

RP54975
O-Ring
Anillo "O"
Joint torique



RP61043
Bonnet Nut
Bonete
Chapeau

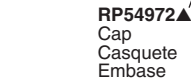

RP54972▲
Cap
Casquete
Embase



RP77551▲
Button
Botón
Bouton



RP72998
Screw
Tornillo
Vis

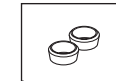

RP50952
Cut -To - Fit Plastic Sleeves
Casquillos cortados a la medida
Bagues d'extrémité pour tubes coupés



RP37490
Thin Deck Aid
Sostén para Bordos Delgados
Plaque de renfort

▲Specify Finish
▲Especifique el Acabado
▲Précisez le Fini