



Webstone®

a brand of **NIBCO®**

PRODUCT CATALOG



MIXING VALVES

WATER HEATER SOLUTIONS

UNDER BOILER SOLUTIONS

HYDRONIC SPECIALTIES

AIR ELIMINATION

EXPANSION TANK PRODUCTS

SYSTEM PERFORMANCE

PUMP FLANGE VALVES

STEP-SAVING VALVES

WORK SMARTER

TABLE OF CONTENTS

G-SERIES® PRODUCTS	4
G-Series® Fittings	5
G-Series® Bodies	6
G-Series® Accessories	6
MIXING VALVES	
Thermostatic Mixing Valves	8
Ultra-Compact Thermostatic Mixing Valve	12
Water Heater Tempering Valve	13
STORAGE TANK WATER HEATER SOLUTIONS	
Pro-Pal® Water Heater Supply Valve	14
Water Heater Service Valve Kits	16
Tempering Service Valve Kits	16
Unions & Dielectric Products	17
TANKLESS WATER HEATER SOLUTIONS	
E-X-P®	20
E2™	20
E3™	20
Ultra-Compact	20
Union Ball	21
E-X-P® Accessories	21
Complete TWH Installation Kits	22
GAS SEDIMENT TRAP	23
UNDER BOILER SOLUTIONS	
Hydro-Core® Manifold	25
Hydro-Core® Complete Near Boiler Piping Kits	26
Hydro-Core® Union Connections	27
E-X-P® Series Wall Hung & Combi Boiler Kits	27
HYDRONIC SPECIALTIES	
Hydraulic Separator	28
Pro-Pal® Purge Tee™	29
Differential Pressure By-Pass Valves	29
AIR ELIMINATION	
Air Separators	30
Automatic Air Vent	30
Pro-Pal® Boiler Vent Valve	32
HYDRONIC EXPANSION TANK PRODUCTS	
Pro-Pal® E-Tank Service Assembly	33
Pro-Pal® Expansion Tank Pro Service Valve™	33

SYSTEM PERFORMANCE

Magnetic Boiler Filters	34
Y-Strainers	38
Pro-Pal® Ball Drain Strainer™	39

PUMP FLANGE VALVES

The Isolator® Rotating Flange	40
The Isolator® Uni-Flange Ball Valve	41
The Isolator® Round Flange	42
The Isolator® Select	43
The Isolator® Double Flanged Check	43

PRO-PAL® STEP-SAVING VALVES

Ball Drain™	44
Union Ball Drain™	45
Union Ball™	46
T-Union Ball Drain™	46
T-Union Ball™	47
L-Union Ball™	47
3-Way Ball Valves	48
T-Valve™	49
Purge & Fill™	50
T-Drain™	50
Add-A-Gauge	50
Add-a-Drain™	51

OTHER VALVES AND FITTINGS

Hose Drain Valves	51
Check Valves	52
Transition Fittings & Tees	54
Pro-Connect ProPush™	58
Pro-Connect™ PP-RCT	60
Ball Valves	62
Transition Ball Valves	63
Specialty Valves	64

INDEX

Terms & Conditions Of Sale	65
Third Party Approvals & Standards	71
Definition Of Terms	71

WORK SMARTER



ONE SOLUTION FOR ANY INSTALLATION

PATENTED TECHNOLOGY WITH FURTHER PATENTS PENDING

- Straight “G” threaded ends and EPDM union gaskets provide a reliable seal without tape or pipe dope, resulting in a more unified looking installation
- Stock a single body and get more from your inventory, with dozens of size and connection type options or accessories
- Eliminate additional adapters or connect different piping materials
- Non-piloting union design simplifies installation, and allows for easy removal and service

G-SERIES UNION FITTING

Choice of FIP, MIP, SWT, FTG, Press, Push, F1960 PEX, F1807 PEX, or PP-RCT system connections in 1/2" - 2" piping sizes

EPDM UNION GASKET

Replaces the need for tape or pipe dope

STRAIGHT G-THREAD END

Available in 1", 1 1/2", & 2" sizes, match body with the accessory/fitting G-Union size

CREATE NEARLY 500 DIFFERENT COMBINATIONS FROM A SINGLE BODY

SAVE SPACE IN THE FIELD AND IN THE TRUCK

Connect different piping types and sizes, right at the valve, without the need for additional adapters. Webstone G-Series products offer significant flexibility from a limited amount of inventory.

- Install accessories between body and fitting to create even more combinations. Choose from a wide selection.
- Save trips to the supply house and create niche configurations on the fly

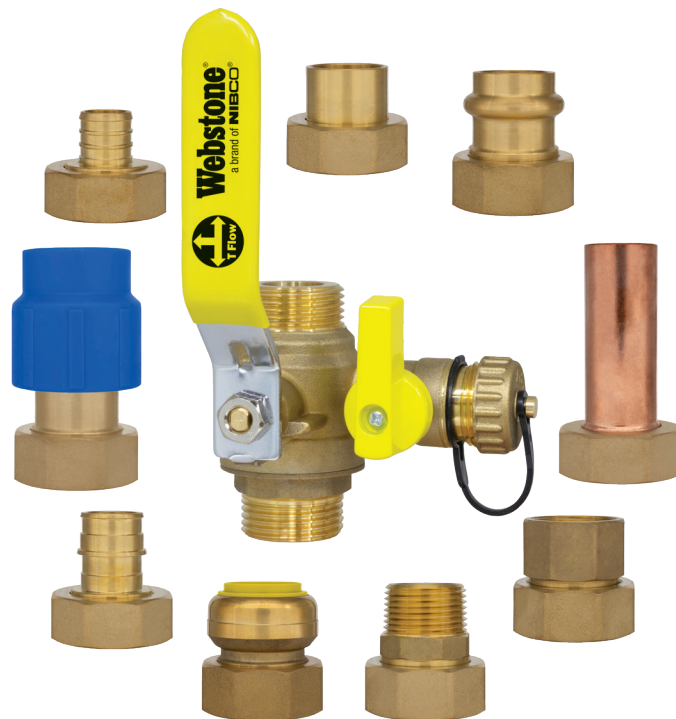

G-SERIES UNION FITTINGS

- Multiple options to customize your installation and simplify future service
- Eliminate additional adapters or connect different piping materials
- Match the G-Thread size with the fitting G-Union size
- Non-piloting design for easy product body removal and service
- Compact fitting design for significantly smaller installations
- Snug-fit gasket design stays in place during installation

G-UNION SIZE	SYSTEM PIPING	FIP	MIP	SWT	FTG	Press	Push	F1960 PEX	F1807 PEX
H-7-x10 Series G-Series Union Fitting									
1"	1/2"	H-7-4102W	H-7-2102W	H-7-5102W	H-7-A104W-R12	H-7-8102W	H-7-6102W	H-7-3102W	H-7-1102W
1"	3/4"	H-7-4103W	H-7-2103W	H-7-5103W	H-7-A104W-R	H-7-8103W	H-7-6103W	H-7-3103W	H-7-1103W
1"	1"	H-7-4104W	H-7-2104W	H-7-5104W	H-7-A104W	H-7-8104W	H-7-6104W	H-7-3104W	H-7-1104W
1 1/2"	1"	H-7-2164W WP	H-7-4164W WP	H-7-5164W WP	-	H-7-8164W WP	-	-	-
1 1/2"	1 1/4"	H-7-2165W WP	H-7-4165W WP	H-7-5165W WP	H-7-A106W-R	H-7-8165W WP	-	-	-
1 1/2"	1 1/2"	H-7-2166W WP	H-7-4166W WP	H-7-5166W WP	H-7-A106W	H-7-8166W WP	-	-	-
2"	1 1/2"	-	-	-	H-7-A107W-R	-	-	-	-
2"	2"	H-7-2177W WP	H-7-4177W WP	H-7-5177W WP	H-7-A107W	H-7-8177W WP	-	-	-

G-UNION SIZE	SYSTEM PIPING	METRIC SOCKET I.D.	Female PP-RCT Metric Socket
H-7-910 Series G-Series Union Fitting			
1"	1/2"	20 mm	H-7-9102W
1"	3/4"	25 mm	H-7-9103W
1"	1"	32 mm	H-7-9104W
1 1/2"	1 1/4"	40 mm	H-7-9165W
1 1/2"	1 1/2"	50 mm	H-7-9166W
2"	2"	63 mm	H-7-9177W

G-SERIES CONTRACTOR KIT

- 48-piece assortment of lead-free G-Series valves and fittings
- Covers a wide variety of installation needs
- Save trips to the supply house and create niche configurations on the fly
- Eliminate additional adapters or connect different piping materials
- Suitable for potable and hydronic applications

G-SERIES CONTRACTOR KIT
48-Piece Assortment of Valves & Fittings

SIZE	ITEM#	LEAD-FREE BRASS CTN/CASE	CASE WT
H-GKIT1 Series			
KIT	H-GKIT1W	1/2	46



DESIGNED TO FIT IN POPULAR STORAGE CASES

*Photo for illustration only, case not included.

48-PIECE KIT INCLUDES:

- 3x G-Series Ball Valve H-G1704W
- 1 SET E-X-P Ultra Compact Tankless Water Heater Service Valve Kit H-G2444W-R
- 1x Residential Pressure Relief Valve H-20713W
- 4x 1/2" Press H-7-8102W
- 4x 3/4" Press H-7-8103W
- 4x 1" Press H-7-8104W
- 2x 1/2" Push H-7-6102W
- 2x 3/4" Push H-7-6103W
- 1x G-Series Ball Drain H-G0614W
- 1x G-Series In-Line Spring Check Valve H-108G4W
- 1x G-Series End Cap H-7-B604W
- 4x 1/2" F1960 PEX H-7-3102W
- 4x 3/4" F1960 PEX H-7-3103W
- 4x 1/2" F1807 PEX H-7-1102W
- 4x 3/4" F1807 PEX H-7-1103W
- 2x 3/4" MIP H-7-2103W
- 1x 1" MIP H-7-2104W
- 2x 3/4" FIP H-7-4103W
- 1x 1" FIP H-7-4104W

G-SERIES BODIES

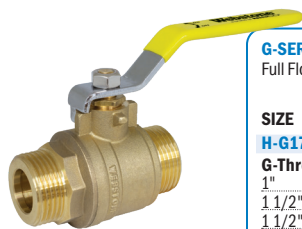

G-SERIES BALL VALVE

Full Flow Forged DZR Brass Ball Valve w/ Adjustable Packing Gland

SIZE	ITEM#	LEAD-FREE BRASS CTN/CASE	CASE WT
H-G170 Series			
G-Thread 200 PSI CWP Max/200°F Max			
1"	H-G1704W	1/16	19
1 1/2"	H-G1706W	1/8	23
1 1/2" x 1"	H-G1706W-R	1/12	15
2"	H-G1707W	1/6	26
2" x 1 1/2"	H-G1707W-R	1/6	18



G-SERIES BALL DRAIN

Full Flow Forged DZR Brass Ball Valve w/ Hi-Flow Hose Drain, Reversible Handle, & Adjustable Packing Glands

SIZE	ITEM#	LEAD-FREE BRASS CTN/CASE	CASE WT
H-G061 Series			
G-Thread 200 PSI CWP Max/200°F Max			
1" x 1"	H-G0614W	1/16	26
1 1/2"	H-G0616W	1/6	22
1 1/2" x 1"	H-G0616W-R	1/12	21
2"	H-G0617W	1/4	21
2" x 1 1/2"	H-G0617W-R	1/6	21



G-SERIES BALL VALVE

Full Flow Forged DZR Brass Ball Valve w/ Reversible Handle & Adjustable Packing Gland

SIZE	ITEM#	LEAD-FREE BRASS CTN/CASE	CASE WT
H-G-x170 Series			
G-Thread x Press 200 PSI CWP Max/200°F Max			
1"	H-G-81704W	1/16	28
1" x 1/2"	H-G-81704W-R12	1/16	18
1" x 3/4"	H-G-81704W-R	1/16	22
1 1/2"	H-G-81706W	1/8	29
1 1/2" x 1 1/4"	H-G-81706W-R	1/8	25
2"	H-G-81707W	1/4	23
2" x 1 1/2"	H-G-81707W-R	1/8	32



G-SERIES BALL DRAIN

Full Flow Forged DZR Brass Ball Valve w/ Hi-Flow Hose Drain, Reversible Handle, & Adjustable Packing Glands

SIZE	ITEM#	LEAD-FREE BRASS CTN/CASE	CASE WT
H-G-x061 Series			
G-Thread x Press 200 PSI CWP Max/200°F Max			
1"	H-G-80614W	1/8	18
1" x 1/2"	H-G-80612W	1/16	24
1" x 3/4"	H-G-80613W	1/16	28
1 1/2"	H-G-80616W	1/4	19
1 1/2" x 1 1/4"	H-G-80616W-R	1/8	29
2"	H-G-80617W	1/4	27



G-SERIES ISOLATION VALVE

Full Flow Forged DZR Brass Ball Valve w/ Reversible Handle & Adjustable Packing Gland • Installs Between G-Series Body & Union Fitting (Sold Separately)

SIZE	ITEM#	LEAD-FREE BRASS CTN/CASE	CASE WT
H-7-G170 Series			
G-Union x G-Thread 200 PSI CWP Max/200°F Max			
1"	H-7-G1704W	1/16	28
1 1/2"	H-7-G1706W	1/8	28
2"	H-7-G1707W	1/4	23



G-SERIES IN-LINE SPRING CHECK VALVE

Forged DZR Brass Body w/ Serviceable Design, Stainless Steel Spring • Soft Seat

SIZE	ITEM#	LEAD-FREE BRASS CTN/CASE	CASE WT
H-108G Series			
G-Thread 200 PSI CWP Max/250°F Max			
1"	H-108G4W	1/24	22
1 1/2"	H-108G6W	1/12	24

G-SERIES ACCESSORIES

G-SERIES UNION ISOLATOR

Full Port Forged DZR Brass Uni-Flange Ball Valve • w/ Detachable Rotating Flange, Adjustable Packing Gland, Nuts & Bolts

SIZE	ITEM#	HV ITEM#	LEAD-FREE BRASS CTN/CASE	CASE WT
H-G14x Series				
G-Union x Rotating Flange 600 PSI CWP Max				
1"	H-G1404W	H-G1404WHV	1/20	35
H-G14x Series				
w/ Multi-Function Hi-Flow Hose Drain				
G-Union x Rotating Flange 600 PSI CWP Max				
1"	H-G1414W	H-G1414WHV	1/20	42

HV ITEMS FIT HIGH VELOCITY & STANDARD SIZE PUMPS



G-SERIES UNION COUPLING

Forged DZR Brass • Installs Between (2) G-Series Bodies (Sold Separately)

SIZE	ITEM#	LEAD-FREE BRASS CTN/CASE	CASE WT
H-7-710 Series			
G-Union x G-Union 200 PSI CWP Max/200°F Max			
1"	H-7-7104W	10/100	33
1 1/2"	H-7-7106W	4/40	27
1 1/2" x 1"	H-7-7106W-R1	6/60	31
2"	H-7-7107W	3/30	29
2" x 1 1/2"	H-7-7107W-R	3/30	26



G-SERIES END CAP

Forged DZR Brass

SIZE	ITEM#	LEAD-FREE BRASS CTN/CASE	CASE WT
H-7-x60 Series			
G-Thread 200 PSI CWP Max/200°F Max			
1"	H-7-B604W	15/150	19
1 1/2"	H-7-B606W	10/100	26
2"	H-7-B607W	8/80	28



G-SERIES UNION ELBOW

Forged DZR Brass • Installs Between G-Series Body & Union Fitting (Sold Separately)











SIZE	ITEM#	LEAD-FREE BRASS CTN/CASE	CASE WT
H-7-G144-A Series			
G-Union x G-Thread 150 PSI CWP Max			
1"	H-7-G144W-A	10/60	29



G-SERIES BODIES

PRODUCT COMPATIBILITY

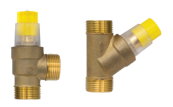
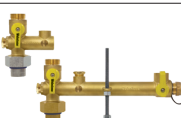
- To ensure compatibility, match the product's G-Thread size with the accessory's or fitting's G-Union size
- Select products also available with union fittings included

	G-THREAD SIZE			1"	1 1/2"	1 1/2" x 1"	2"	2" x 1 1/2"
	G-SERIES PRODUCT	MORE INFO	# G ENDS	BODY ONLY ITEM#				
	BALL VALVE	63	2	H-G1704W	H-G1706W	H-G1706W-R	H-G1707W	H-G1707W-R
	G-THREAD x PRESS BALL VALVE Press End Sizes: *1/2", †3/4", ‡1 1/4", **1 1/2"	63	1	H-G-81704W H-G-81704W-R12* H-G-81704W-R†	H-G-81706W H-G-81706W-R†	-	H-G-81707W H-G-81707W-R**	-
	PRO-PAL® BALL DRAIN	45	2	H-G0614W	H-G0616W	H-G0616W-R	H-G0617W	H-G0617W-R
	G-THREAD x PRESS PRO-PAL® BALL DRAIN Press End Sizes: *1/2", †3/4", ‡1 1/4"	45	1	H-G-80614W H-G-80612W* H-G-80613W†	H-G-80616W H-G-80616W-R†	-	H-G-80617W	-
	PRO-PAL® MULTI-PORT TEE	57	5	H-G664W	-	-	-	-
	CHECK VALVE	52	2	H-108G4W	H-108G6W	-	-	-
	PRO-PAL® ADD-A-DRAIN	51	1	H-G0304W	H-G0306W	-	-	-
	PRO-PAL® T-VALVE	49	3	H-G7674W	H-G7676W	H-G7674W-T112	-	-
	Y-STRAINER	38	2	H-G0564W	H-G0566W	-	-	-
	PRO-PAL® BALL DRAIN STRAINER	39	2	H-G1564W	H-G1566W	-	-	-
	MAGNETIC BOILER FILTER	35	2	H-70700	-	-	-	-
	MAGNETIC BOILER FILTER XL	34	2	-	H-70706	-	-	-
	HYDRAULIC SEPARATOR	28	4	-	H-76406	-	-	-
	VERTICAL AIR SEPARATOR	31	2	H-71000-V	-	-	-	-
	HORIZONTAL AIR SEPARATOR	30	2	H-7G004	H-7G006	-	H-7G007	-
	DIFFERENTIAL PRESSURE BY-PASS VALVE	9 GPM MAX	29	2	H-70530	-	-	-
	18 GPM MAX	29	2	H-70540	-	-	-	
	ANGLED DIFFERENTIAL PRESSURE BY-PASS VALVE	9 GPM MAX	29	2	H-70530-A	-	-	-
		18 GPM MAX	29	2	H-70540-A	-	-	-
	WATER HEATER SUPPLY VALVE	Dielectric 3/4" FIP Union	14	1	H-G1663W	-	-	-
		Brass 3/4" FIP Union	14	1	H-G2663W	-	-	-
	WATER HEATER SUPPLY VALVE W/ EXPANSION TANK SERVICE	Dielectric 3/4" FIP Union	14	1	H-G1653W	-	-	-
		Brass 3/4" FIP Union	14	1	H-G2653W	-	-	-
	E-X-P® ULTRA-COMPACT TWH SERVICE VALVE KIT 3/4" FIP Union	Service Valves Only	20	1+1	H-G2444W-R	-	-	-
		w/ PRV	20	1+1	H-G2444W-RPR	-	-	-
		w/ Gas Sediment Trap	20	1+1	H-G2444W-R-PR-GST	-	-	-

G-SERIES GAUGE FITTINGS

G-SERIES TEMPERATURE GAUGE FITTING

Forged DZR Brass Union Fitting • w/ Back Mounted Temperature Gauge (32°-248°F), Dual Scale 1 1/2" Dial • Installs Between G-Series Body & Union Fitting (Sold Separately)

SIZE	ITEM#	CTN/CASE	CASE WT
LEAD-FREE BRASS			
H-3200 Series			
G-Union x G-Thread		150 PSI CWP Max	
1"	H-3200W	10/100	61



G-SERIES PRESSURE GAUGE FITTING

Forged DZR Brass Union Fitting w/ Back Mounted Pressure Gauge • Installs Between G-Series Body & Union Fitting (Sold Separately)

SIZE	ITEM#	CTN/CASE	CASE WT
LEAD-FREE BRASS			
H-7-x30 Series			
w/ 60 PSI Max Gauge			
G-Union x G-Thread		60 PSI CWP Max/200°F Max	
1"	H-7-G304W-60	1/18	11
1 1/2"	H-7-G306W-60	1/10	9
H-7-x30 Series			
w/ 140 PSI Max Gauge			
G-Union x G-Thread		140 PSI CWP Max/200°F Max	
1"	H-7-G304W-140	1/18	11
1 1/2"	H-7-G306W-140	1/10	9



THERMOSTATIC MIXING VALVES

RIGHT TEMPERATURE RIGHT CONNECTION



SEE PAGES 4-7

- Mixes hot and cold water to pre-set output temperature
- Heavy duty lead-free forged brass construction
- Four temperature range options provide versatility to accommodate different application and heat source requirements
- FIP, MIP, SWT, Push, Press, F1807 PEX, F1960 PEX connections
- Choice of T-Pattern or Y-Pattern body design to accommodate a range of installation needs
- Easy temperature locking handle (except -CAN models)
- Removable check valves integrated in inlet fittings



TWO BODY STYLES



T-PATTERN DESIGN
Widest selection of temperature ranges covers the most applications



Y-PATTERN DESIGN
Aligned hot and mixed ports for easy installation into existing piping

FOUR TEMPERATURE RANGES

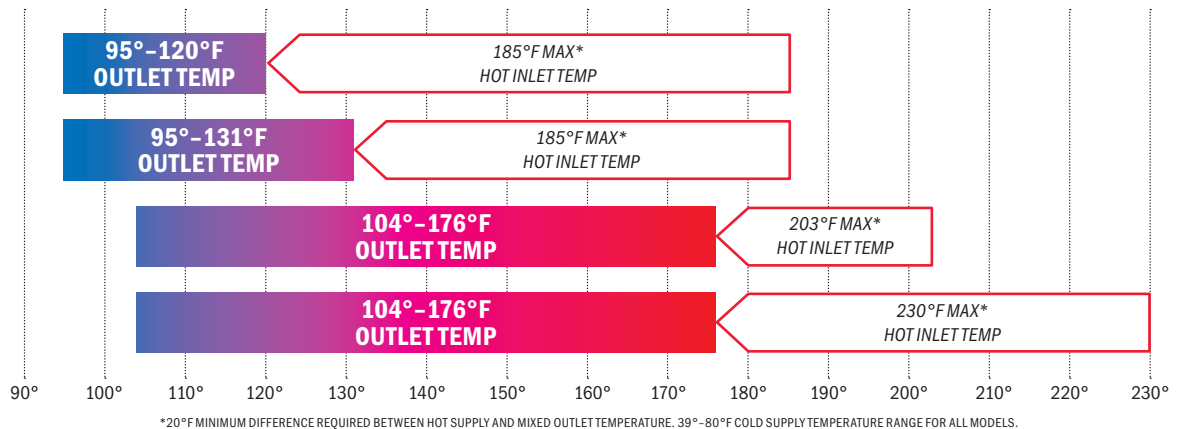

THERMOSTATIC MIXING VALVES APPLICATIONS

WATER DISTRIBUTION SYSTEMS

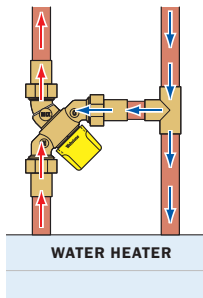

Install at water heater to set the maximum temperature for entire system.

Water Heater Tempering Valve is an additional solution - See Page 13

LOW TEMP HYDRONIC

Set a maximum temperature up to 131°F for radiant floor or other low temp heating application

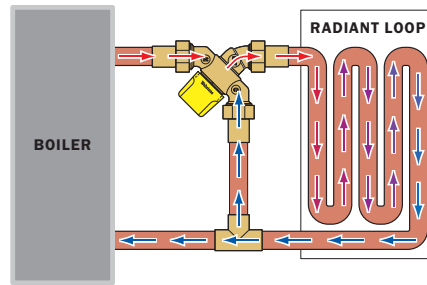

HIGH TEMP HYDRONIC

Set a maximum temperature up to 176°F for radiant floor, baseboard heat, radiators, or other high temp heating application

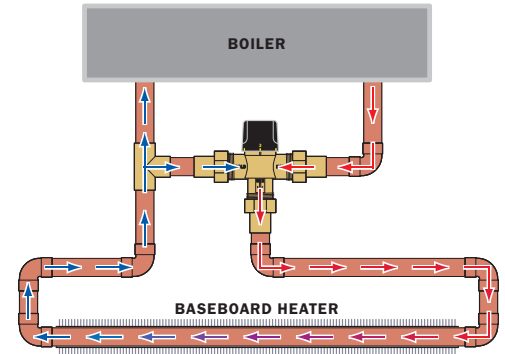

SOLAR HEAT SOURCE

Accepts high temperature outputs from solar heat sources, then mixes with cold water supply to achieve temperatures for the desired application

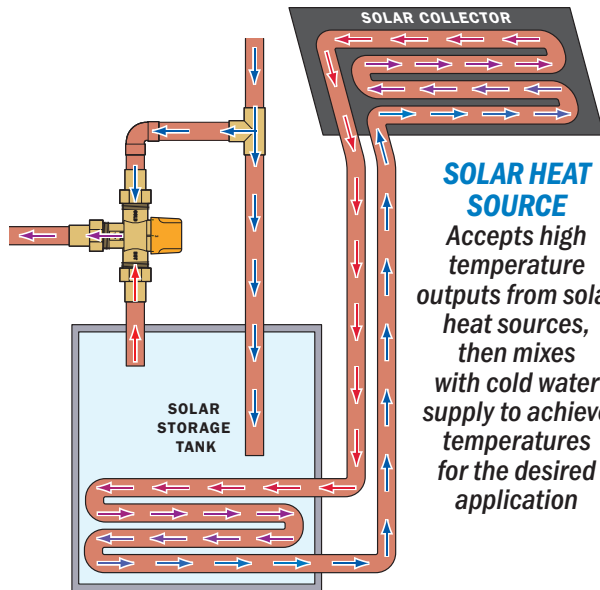

POINT-OF-USE - SINGLE FIXTURE

Set the maximum temperature of each fixture individually

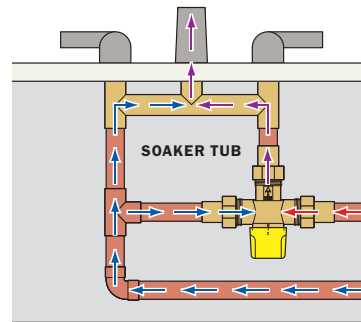

POINT OF USE - MULTI FIXTURE

Set the maximum temperature for a group of fixtures

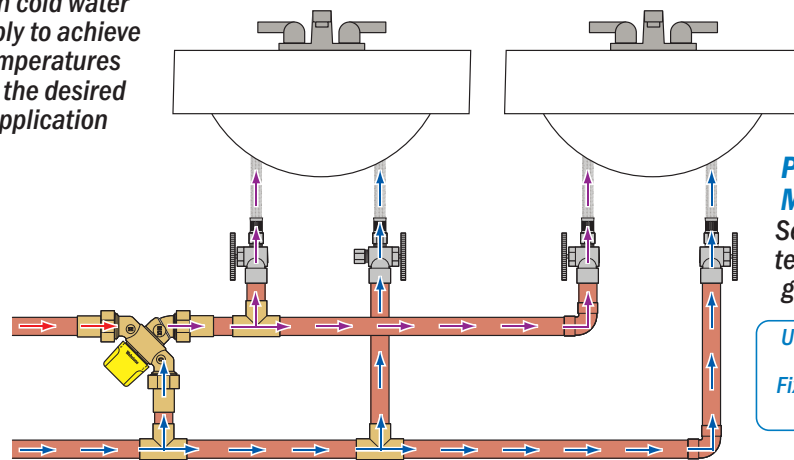

Ultra-Compact TMV ideal for Single Fixture Point of Use - See Page 12

APPLICATION	WATER DISTRIBUTION SYSTEMS		LOW TEMP HYDRONIC	HIGH TEMP HYDRONIC	SOLAR HEAT SOURCE	POINT OF USE SINGLE OR MULTI FIXTURE	
MIXED OUTPUT TEMP RANGE	95° - 120°F (35° - 49°C)	95° - 131°F (35° - 55°C)	95° - 131°F (35° - 55°C)	104° - 176°F (40° - 80°C)	104° - 176°F (40° - 80°C)	95° - 120°F (35° - 49°C)	95° - 131°F (35° - 55°C)
HOT INLET TEMP	185°F MAX	185°F MAX	185°F MAX	203°F MAX	230°F MAX	185°F MAX	185°F MAX
T-PATTERN DESIGN	H-TMV-120 Series	H-TMV-131 Series	H-TMV-131 Series	H-TMV-176 Series	H-TMV-230F Input Series	H-TMV-120 Series (FIP & SWT Models Only)	H-TMV-131 Series (FIP & SWT Models Only)
Y-PATTERN DESIGN	-	H-TMV-131-Y Series	H-TMV-131-Y Series	H-TMV-176-Y Series	-	-	-
Y-PATTERN DESIGN w/ Temperature Gauge	-	H-TMV-131-Y-TG Series	H-TMV-131-Y-TG Series	H-TMV-176-Y-TG Series	-	-	-
BODY ONLY • Install w/ (3) G-Union Fittings							
T-PATTERN DESIGN	H-7000-CAN Series	H-7000 Series	H-7000 Series	H-7007 Series	H-7006 Series	-	-
Y-PATTERN DESIGN	-	H-7000-Y Series	-	H-7007-Y Series	-	-	-

THERMOSTATIC MIXING VALVES

Y-PATTERN THERMOSTATIC MIXING VALVE

In-Line DZR Brass Valve w/ Angled Cold Inlet • Locking Handle, (3) DZR Brass G-Series Unions w/ Integral Check Valves on Inlets • For Water Distribution Applications • Outlet Temperature Range 95° - 131°F

SIZE	ITEM#	LEAD-FREE BRASS	CTN/CASE	CASE WT
H-TMV-131-Y Series				
150 PSI CWP Max/185°F Max				
FIP				
1/2"	H-72202W-Y		1/10	23
3/4"	H-72203W-Y		1/10	23
1"	H-72204W-Y		1/10	26
MIP				
1/2"	H-74202W-Y		1/10	20
3/4"	H-74203W-Y		1/10	20
1"	H-74204W-Y		1/10	24
SWT				
1/2"	H-75202W-Y		1/10	20
3/4"	H-75203W-Y		1/10	20
1"	H-75204W-Y		1/10	23
Press				
1/2"	H-78202W-Y		1/10	21
3/4"	H-78203W-Y		1/10	23
1"	H-78204W-Y		1/10	23
Push				
1/2"	H-76202W-Y		1/10	22
3/4"	H-76203W-Y		1/10	23
F1960 PEX				
1/2"	H-73202W-Y		1/10	19
3/4"	H-73203W-Y		1/10	20
F1807 PEX				
1/2"	H-71202W-Y		1/10	21
3/4"	H-71203W-Y		1/10	21

SIZE	ITEM#	LEAD-FREE BRASS	CTN/CASE	CASE WT
H-TMV-131-Y-TG Series				
Includes Dual Scale Temperature Gauge Fitting				
150 PSI CWP Max/185°F Max				
FIP				
1/2"	H-72202W-Y-TG		1/10	28
3/4"	H-72203W-Y-TG		1/10	28
1"	H-72204W-Y-TG		1/10	30
MIP				
1/2"	H-74202W-Y-TG		1/10	25
3/4"	H-74203W-Y-TG		1/10	25
1"	H-74204W-Y-TG		1/10	28
SWT				
1/2"	H-75202W-Y-TG		1/10	25
3/4"	H-75203W-Y-TG		1/10	25
1"	H-75204W-Y-TG		1/10	28
Press				
1/2"	H-78202W-Y-TG		1/10	26
3/4"	H-78203W-Y-TG		1/10	28
1"	H-78204W-Y-TG		1/10	28
Push				
1/2"	H-76202W-Y-TG		1/10	27
3/4"	H-76203W-Y-TG		1/10	28
F1960 PEX				
1/2"	H-73202W-Y-TG		1/10	24
3/4"	H-73203W-Y-TG		1/10	24
F1807 PEX				
1/2"	H-71202W-Y-TG		1/10	26
3/4"	H-71203W-Y-TG		1/10	26

SIZE	ITEM#	LEAD-FREE BRASS	CTN/CASE	CASE WT
H-7000-Y Series				
Body Only • Install w/ (3) G-Union Fittings				
G-Thread				
1"	H-7000W-Y		1/10	14



TG ITEMS INCLUDE DUAL-SCALE TEMPERATURE GAUGE FITTING
1 1/2" gauge reads 32°-248°F

Y-PATTERN THERMOSTATIC MIXING VALVE

In-Line DZR Brass Valve w/ Angled Cold Inlet • Locking Handle, (3) DZR Brass G-Series Unions w/ Integral Check Valves on Inlets • For High Temperature Hydronic Applications • Outlet Temperature Range 104° - 176°F

SIZE	ITEM#	LEAD-FREE BRASS	CTN/CASE	CASE WT
H-TMV-176-Y Series				
150 PSI CWP Max/203°F Max				
FIP				
1/2"	H-72272W-Y		1/10	23
3/4"	H-72273W-Y		1/10	23
1"	H-72274W-Y		1/10	26
MIP				
1/2"	H-74272W-Y		1/10	20
3/4"	H-74273W-Y		1/10	20
1"	H-74274W-Y		1/10	24
SWT				
1/2"	H-75272W-Y		1/10	20
3/4"	H-75273W-Y		1/10	20
1"	H-75274W-Y		1/10	23
Press				
1/2"	H-78272W-Y		1/10	21
3/4"	H-78273W-Y		1/10	23
1"	H-78274W-Y		1/10	23
F1960 PEX				
1/2"	H-73272W-Y		1/10	19
3/4"	H-73273W-Y		1/10	20
F1807 PEX				
1/2"	H-71272W-Y		1/10	21
3/4"	H-71273W-Y		1/10	21

SIZE	ITEM#	LEAD-FREE BRASS	CTN/CASE	CASE WT
H-TMV-176-Y-TG Series				
Includes Dual Scale Temperature Gauge Fitting				
150 PSI CWP Max/203°F Max				
FIP				
1/2"	H-72272W-Y-TG		1/10	28
3/4"	H-72273W-Y-TG		1/10	28
1"	H-72274W-Y-TG		1/10	30
MIP				
1/2"	H-74272W-Y-TG		1/10	25
3/4"	H-74273W-Y-TG		1/10	25
1"	H-74274W-Y-TG		1/10	28
SWT				
1/2"	H-75272W-Y-TG		1/10	25
3/4"	H-75273W-Y-TG		1/10	25
1"	H-75274W-Y-TG		1/10	28
Press				
1/2"	H-78272W-Y-TG		1/10	26
3/4"	H-78273W-Y-TG		1/10	28
1"	H-78274W-Y-TG		1/10	28
F1960 PEX				
1/2"	H-73272W-Y-TG		1/10	24
3/4"	H-73273W-Y-TG		1/10	24
F1807 PEX				
1/2"	H-71272W-Y-TG		1/10	26
3/4"	H-71273W-Y-TG		1/10	26

SIZE	ITEM#	LEAD-FREE BRASS	CTN/CASE	CASE WT
H-7007-Y Series				
Body Only • Install w/ (3) G-Union Fittings				
G-Thread				
1"	H-7007W-Y		1/10	14

MIXING VALVE FITTINGS & ACCESSORIES

- Fittings and accessories designed exclusively for use with G-Series Thermostatic Mixing Valves (TMV)
- Fittings include in-line check valves for TMV hot and cold inlets



G-UNION SIZE	SYSTEM PIPING	FIP	MIP	SWT	Press	Push	F1960 PEX	F1807 PEX
H-7-x20 Series								
G-Series Union Fitting w/Check • For Mixing Valve Applications								
1"	1/2"	H-7-2202W WP	H-7-4202W WP	H-7-5202W WP	H-7-8202W WP	H-7-6202W WP	H-7-3202W WP	H-7-1202W WP
1"	3/4"	H-7-2203W WP	H-7-4203W WP	H-7-5203W WP	H-7-8203W WP	H-7-6203W WP	H-7-3203W WP	H-7-1203W WP
1"	1"	H-7-2204W WP	H-7-4204W WP	H-7-5204W WP	H-7-8204W WP	-	H-7-3204W WP	H-7-1204W WP

G-SERIES ISOLATION BALL VALVES

w/ Reversible Handle & Adjustable Packing Gland • Installs Between G-Series Body & Union Fitting (Sold Separately) • Choice of Straight or Angled Design

SIZE	STRAIGHT	ANGLED#	LEAD-FREE BRASS	CTN/CASE	CASE WT
H-7-G234 Series					
Yellow Handle					
G-Union × G-Thread					
1"	H-7-G134WY	H-7-G134WY-A		10/60	51
H-7-G234 Series					
Red Handle & Integral Check Valve • Mixing Valve Applications					
G-Union × G-Thread					
1"	H-7-G234WR	H-7-G234WR-A		10/60	51
H-7-G234 Series					
Blue Handle & Integral Check Valve • Mixing Valve Applications					
G-Union × G-Thread					
1"	H-7-G234WB	H-7-G234WB-A		10/60	51

THERMOSTATIC MIXING VALVES

THERMOSTATIC MIXING VALVE

Forged Brass Valve • (3) DZR Brass G-Series Union Fittings w/ Integral Check Valves on Inlets • For Water Distribution Systems • Outlet Temperature Range 95°- 120°F

SIZE	ITEM#	LEAD-FREE BRASS	
		CTN/CASE	CASE WT
H-TMV-120 Series			
FIP		150 PSI CWP Max/185°F Max	
1/2"	H-72202W-CAN	1/10	21
3/4"	H-72203W-CAN	1/10	22
1"	H-72204W-CAN	1/10	24
MIP			
1/2"	H-74202W-CAN	1/10	19
3/4"	H-74203W-CAN	1/10	20
1"	H-74204W-CAN	1/10	22
SWT			
1/2"	H-75202W-CAN	1/10	19
3/4"	H-75203W-CAN	1/10	19
1"	H-75204W-CAN	1/10	21
Press			
1/2"	H-78202W-CAN	1/10	19
3/4"	H-78203W-CAN	1/10	21
1"	H-78204W-CAN	1/10	22
Push			
1/2"	H-76202W-CAN	1/10	21
3/4"	H-76203W-CAN	1/10	22
F1960 PEX			
1/2"	H-73202W-CE-CAN	1/10	18
3/4"	H-73203W-CE-CAN	1/10	18
F1807 PEX			
1/2"	H-71202W-CAN	1/10	18
3/4"	H-71203W-CAN	1/10	18
H-7000-CAN Series			
Body Only • Install w/ (3) G-Union Fittings			
G-Thread		150 PSI CWP Max/185°F Max	
1"	H-70000W-CAN	1/10	12



THERMOSTATIC MIXING VALVE

Forged Brass Valve w/ Temperature Locking Handle • (3) DZR Brass G-Series Union Fittings w/ Integral Check Valves on Inlets • For High Temperature Hydronic Applications • Outlet Temperature Range 104°- 176°F

SIZE	ITEM#	LEAD-FREE BRASS	
		CTN/CASE	CASE WT
H-TMV-176 Series			
FIP		150 PSI CWP Max/203°F Max	
1/2"	H-72272W	1/10	21
3/4"	H-72273W	1/10	22
1"	H-72274W	1/10	24
MIP			
1/2"	H-74272W	1/10	19
3/4"	H-74273W	1/10	19
1"	H-74274W	1/10	21
SWT			
1/2"	H-75272W	1/10	14
3/4"	H-75273W	1/10	19
1"	H-75274W	1/10	20
Press			
1/2"	H-78272W	1/10	19
3/4"	H-78273W	1/10	21
1"	H-78274W	1/10	21
F1807 PEX			
1/2"	H-71272W	1/10	20
3/4"	H-71273W	1/10	20
F1960 PEX			
1/2"	H-73272W	1/10	20
3/4"	H-73273W	1/10	21
H-7007 Series			
Body Only • Install w/ (3) G-Union Fittings			
G-Thread		150 PSI CWP Max/203°F Max	
1"	H-70070W	1/10	12

THERMOSTATIC MIXING VALVE

Forged Brass Valve w/ Temperature Locking Handle • (3) DZR Brass G-Series Union Fittings w/ Integral Check Valves on Inlets • For Low Temp Hydronic Heat and Water Distribution Systems • Outlet Temperature Range 95°- 131°F

SIZE	ITEM#	LEAD-FREE BRASS	
		CTN/CASE	CASE WT
H-TMV-131 Series			
FIP		150 PSI CWP Max/185°F Max	
1/2"	H-72202W	1/10	21
3/4"	H-72203W	1/10	22
1"	H-72204W	1/10	24
MIP			
1/2"	H-74202W	1/10	19
3/4"	H-74203W	1/10	19
1"	H-74204W	1/10	23
SWT			
1/2"	H-75202W	1/10	17
3/4"	H-75203W	1/10	19
1"	H-75204W	1/10	22
Press			
1/2"	H-78202W	1/10	20
3/4"	H-78203W	1/10	21
1"	H-78204W	1/10	22
Push			
1/2"	H-76202W	1/10	21
3/4"	H-76203W	1/10	22
F1960 PEX			
1/2"	H-73202W-CE	1/10	20
3/4"	H-73203W-CE	1/10	20
F1807 PEX			
1/2"	H-71202W	1/10	20
3/4"	H-71203W	1/10	20
H-7000 Series			
Body Only • Install w/ (3) G-Union Fittings			
G-Thread		150 PSI CWP Max/185°F Max	
1"	H-70000W	1/10	12

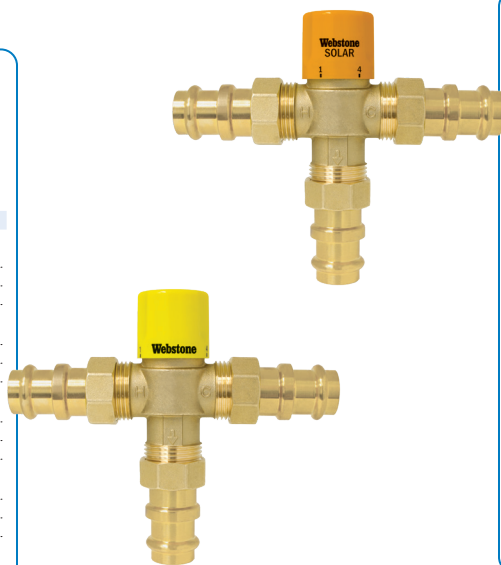

THERMOSTATIC MIXING VALVE

Forged Brass Valve w/ Temperature Locking Handle • (3) DZR Brass G-Series Union Fittings w/ Integral Check Valves on Inlets • For Solar Applications - Max Input 230°F • Outlet Temperature Range 104°- 176°F

SIZE	ITEM#	LEAD-FREE BRASS	
		CTN/CASE	CASE WT
H-TMV-230F Input Series			
FIP		150 PSI CWP Max/230°F Max	
1/2"	H-72262W	1/10	21
3/4"	H-72263W	1/10	22
1"	H-72264W	1/10	24
MIP			
1/2"	H-74262W	1/10	19
3/4"	H-74263W	1/10	19
1"	H-74264W	1/10	23
SWT			
1/2"	H-75262W	1/10	17
3/4"	H-75263W	1/10	19
1"	H-75264W	1/10	22
Press			
1/2"	H-78262W	1/10	20
3/4"	H-78263W	1/10	21
1"	H-78264W	1/10	22
H-7006 Series			
Body Only • Install w/ (3) G-Union Fittings			
G-Thread		150 PSI CWP Max/230°F Max	
1"	H-70060W	1/10	12

CHECK INSERTS

SET OF 2 IN-LINE CHECK INSERTS & RETAINING RINGS

For Use With Webstone H-7-x20 Fittings

SIZE	ITEM#	LEAD-FREE BRASS	
		CTN/CASE	CASE WT
H-7-7x20-C7 Series			
For Mixing Valve Applications • Max Input 203°F			
3/4"	H-C7-203	10/100	2
H-7-7x20-C7 Series			
For Solar Mixing Valve Applications • Max Input 230°F			
3/4"	H-C7-303	10/500	7276

• Choice of two temperature ranges



ULTRA-COMPACT THERMOSTATIC MIXING VALVE

- Ultra-compact 2½" x 3¼" body
- Ideal for discrete under sink installations
- 95°-120°F output range with locking handle, factory preset at 120°F
- Integral check valves and strainers on inlets
- Available accessories include elbow, tee, and 20°-220°F dual-scale temperature gauge
- DZR brass or bronze body options

Includes mounting bracket

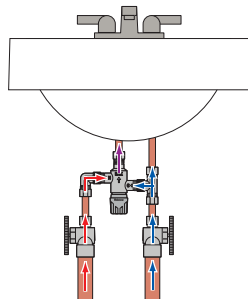

POINT-OF-USE-SINGLE FIXTURE
Set the maximum temperature of each fixture individually

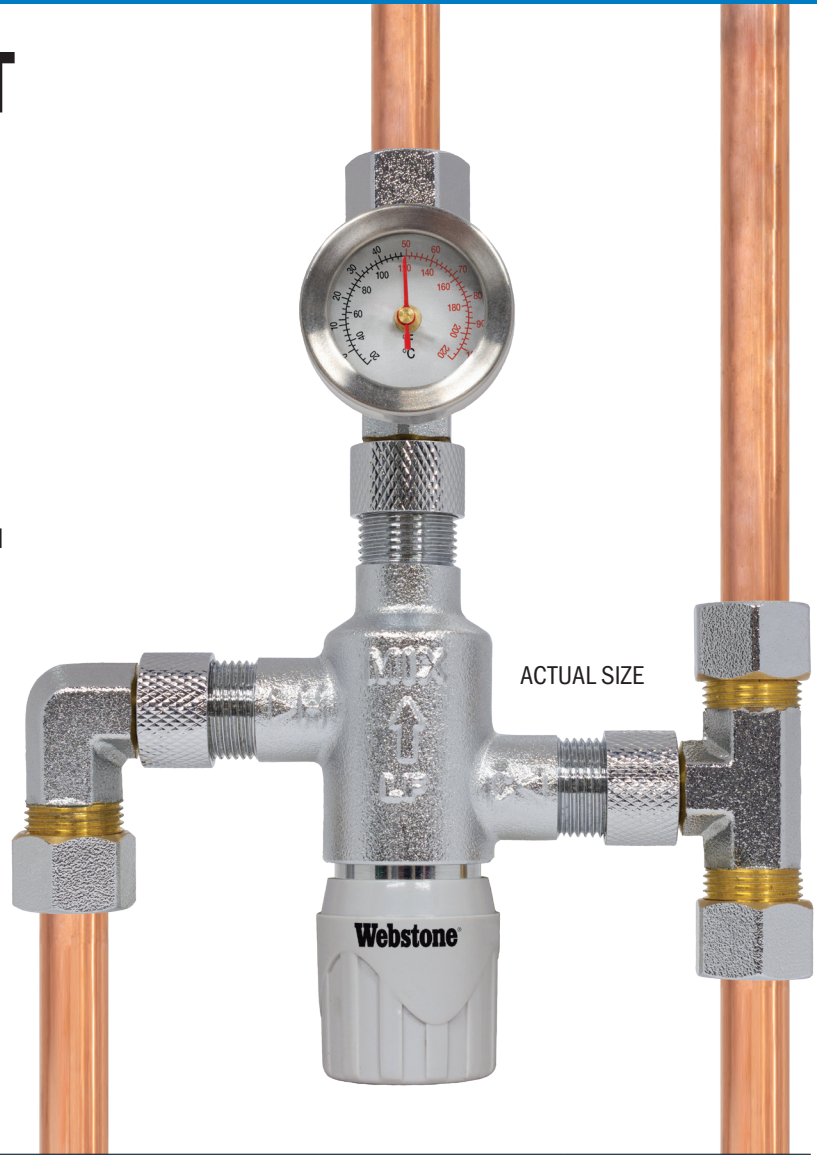

Ultra-Compact Thermostatic Mixing Valves					150 PSI CWP Max/180°F Max	
MIXED OUTPUT TEMP RANGE	95° - 120°F (35° - 49°C)	95° - 120°F (35° - 49°C)	95° - 120°F (35° - 49°C)	95° - 120°F (35° - 49°C)	95° - 120°F (35° - 49°C)	
HOT INLET TEMP	180°F MAX	180°F MAX	180°F MAX	180°F MAX	180°F MAX	
H-772x Series Lead-Free Chrome-Plated Forged DZR Brass Thermostatic Mixing Valve						
3/8" COMPRESSION	H-77201W	H-77201W-TG	H-77201W-T	H-77211W	H-77211W-TG	
1/4" PUSH	-	-	-	H-77610W	H-77610W-TG	
H-774x Series Lead-Free Chrome-Plated DZR Bronze Thermostatic Mixing Valve						
3/8" COMPRESSION	H-77401W	H-77401W-TG	-	H-77411W	H-77411W-TG	

Certification applies to bronze body H-77401W

CHROME-PLATED FORGED DZR BRASS FITTINGS

SIZE	ITEM#	LEAD-FREE BRASS CTN/CASE	CASE WT
H-7-7211 Series Tee, Elbow, & Cap			
Compression		150 PSI CWP Max/180°F Max	
3/8"	H-7-7211W WP	5/50	13
H-7-7211 Series 1" Dial - Temperature Range 20 - 220° F			
Compression		150 PSI CWP Max/	
3/8"	H-33000W	10/100	16



CHROME-PLATED FORGED DZR BRASS FITTINGS & Removal Tool

SIZE	ITEM#	LEAD-FREE BRASS CTN/CASE	CASE WT
H-7-7211 Series			
Push		150 PSI CWP Max/180°F Max	
1/4"	H-7-7610W WP	5/50	3
H-7-7211 Series w/ Temperature Gauge			
Push		150 PSI CWP Max/180°F Max	
1/4"	H-7-7610W-TG WP	5/50	7



WATER HEATER TEMPERING VALVE

HOT WATER MADE BETTER

GREATER & SAFER HOT WATER OUTPUT PER GALLON STORED

- Allows water heater to be set at 140°F, minimizing risk of Legionella bacteria in the tank
- Mixes hot output with cold supply for greater effective hot water storage
- Adjustable temperature control limits output to 120°F to prevent risk of scalding
- Integrated recirculation port simplifies installation

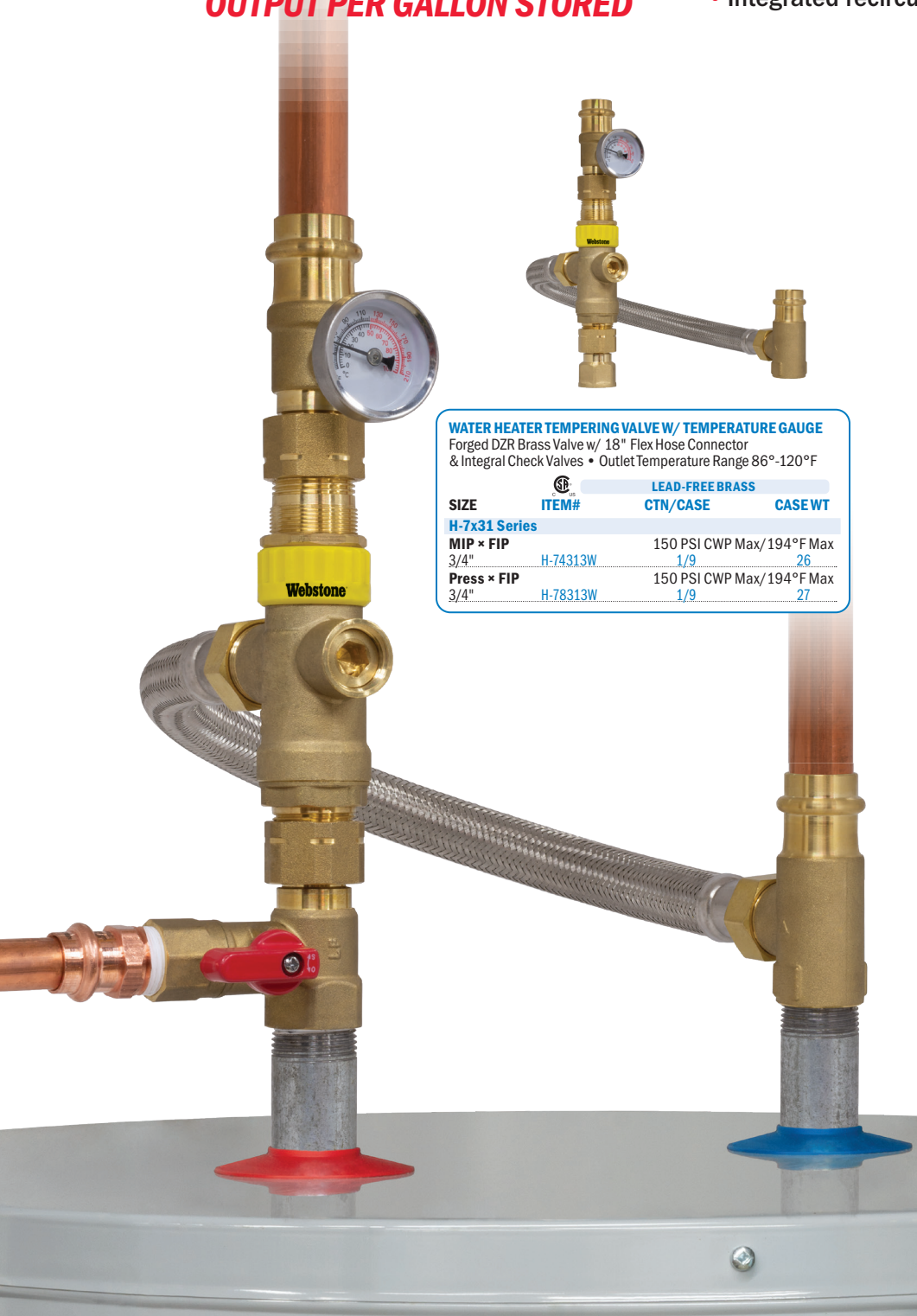

WATER HEATER TEMPERING VALVE W/ TEMPERATURE GAUGE
 Forged DZR Brass Valve w/ 18" Flex Hose Connector & Integral Check Valves • Outlet Temperature Range 86°-120°F

SIZE	ITEM#	LEAD-FREE BRASS CTN/CASE	CASE WT
H-7x31 Series			
MIP × FIP		150 PSI CWP Max/194°F Max	
3/4"	H-74313W	1/9	26
Press × FIP		150 PSI CWP Max/194°F Max	
3/4"	H-78313W	1/9	27

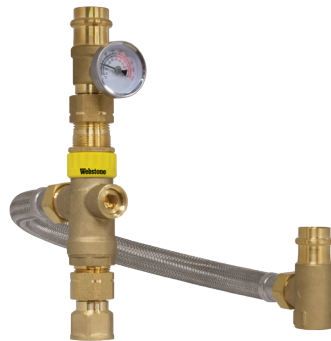

WATER HEATER TEMPERING VALVE W/ TEMPERATURE GAUGE & BY-PASS
 Forged DZR Brass Valve, w/ 18" Flex Hose Connector, Temperature Gauge, Integral Check Valves & Tempering By-Pass Valve • Outlet Temperature Range 86°-120°F

SIZE	ITEM#	LEAD-FREE BRASS CTN/CASE	CASE WT
H-7x32 Series			
MIP × FIP		150 PSI CWP Max/194°F Max	
3/4"	H-74323W	1/9	33
Press × FIP		150 PSI CWP Max/194°F Max	
3/4"	H-78323W	1/9	33



TEMPERING BY-PASS VALVE

Provides high-temp untempered water to appliances



WATER HEATER TEMPERING BY-PASS VALVE
 Forged DZR Brass Valve w/ 1/2 Plugged FIP Port For Direct Connection to High-Temp Appliance

SIZE	ITEM#	LEAD-FREE BRASS CTN/CASE	CASE WT
H-G067 Series			
G-Union × FIP		150 PSI CWP Max/194°F Max	
3/4"	H-G0673W	6/48	35



WATER HEATER SUPPLY VALVE

PATENTS PENDING

- Simplifies storage tank water heater installations
- Choice of FIP dielectric or brass union water heater connection
- Integrated valves isolate water supply and expansion tank for service
- 1/2" FIP cold water tapping for Water Heater Tempering Valve
- 1/2" FIP port for installation of vacuum relief valve
- 1/8" plugged gauge port
- Compatible with 3/4" MIP expansion tanks up to 5 gallons, includes mounting hardware and two 1/2" plugs
- FIP, MIP, SWT, Press or Push system connection
- Compact version available if expansion tank is not required



SEE PAGES 4-7

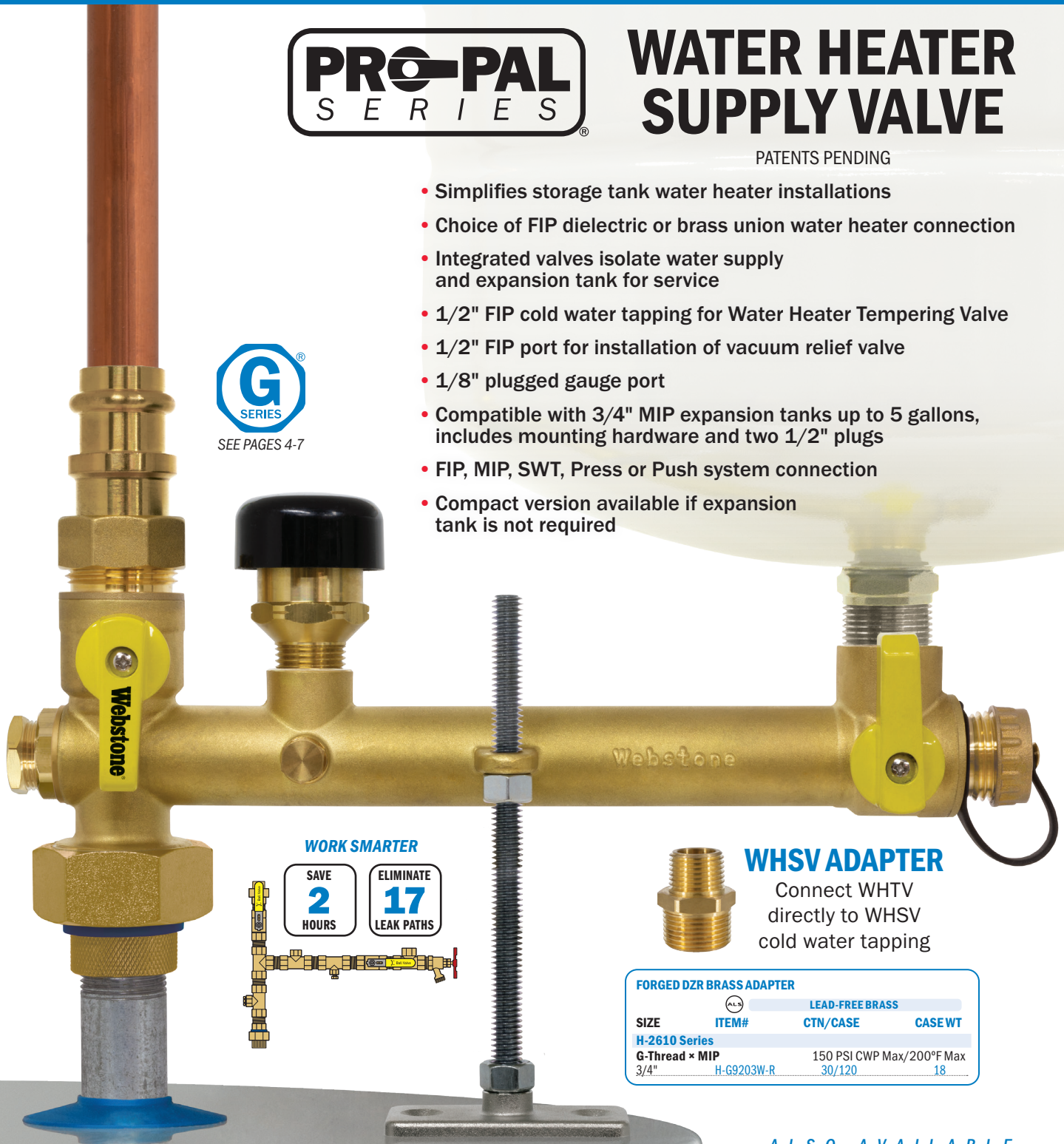

WORK SMARTER

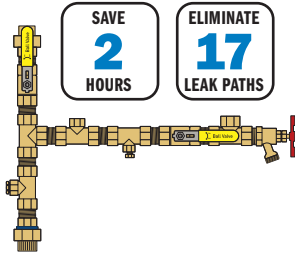

SAVE
2
HOURS

ELIMINATE
17
LEAK PATHS



WHSV ADAPTER

Connect WHTV directly to WHSV cold water tapping

FORGED DZR BRASS ADAPTER

SIZE	ITEM#	LEAD-FREE BRASS	CASE WT
H-2610 Series		CTN/CASE	
G-Thread x MIP		150 PSI CWP Max/200°F Max	
3/4"	H-G9203W-R	30/120	18

ALSO AVAILABLE



T-VALVE

Ideal for expansion tanks - See Page 49



WATER HEATER SUPPLY VALVES

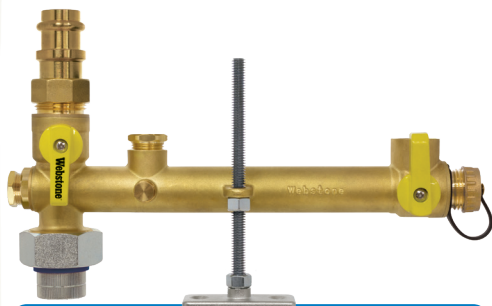

PRO-PAL DIELECTRIC WATER HEATER SUPPLY VALVE W/ EXPANSION TANK SERVICE

Full Port DZR Brass Ball w/ Dielectric Union End w/ 3/4 Expansion Tank Port & Hi-Flow Hose Drain (3) Plugged FIP Ports (1/2", 1/2" & 1/8") • Includes Mounting Hardware

SIZE	ITEM#	LEAD-FREE BRASS	
		CTN/CASE	CASE WT
H-x165 Series			
FIP Union × FIP 150 PSI CWP Max/180°F Max			
3/4" × 1/2"	H-41652W	1/8	32
3/4"	H-41653W	1/8	33
FIP Union × MIP			
3/4" × 1/2"	H-21652W	1/8	32
3/4"	H-21653W	1/8	32
FIP Union × SWT			
3/4" × 1/2"	H-51652W	1/8	32
3/4"	H-51653W	1/8	32
FIP Union × Press			
3/4" × 1/2"	H-81652W	1/8	32
3/4"	H-81653W	1/8	33
FIP Union × Push			
3/4" × 1/2"	H-61652W	1/8	32
3/4"	H-61653W	1/8	33
H-x165-VR Series			
w/ Vacuum Relief Valve			
FIP Union × FIP 150 PSI CWP Max/180°F Max			
3/4" × 1/2"	H-41652W-VR	1/8	32
3/4"	H-41653W-VR	1/8	35
FIP Union × MIP			
3/4" × 1/2"	H-21652W-VR	1/8	32
3/4"	H-21653W-VR	1/8	34
FIP Union × SWT			
3/4" × 1/2"	H-51652W-VR	1/8	32
3/4"	H-51653W-VR	1/8	34
FIP Union × Press			
3/4" × 1/2"	H-81652W-VR	1/8	32
3/4"	H-81653W-VR	1/8	35
FIP Union × Push			
3/4" × 1/2"	H-61652W-VR	1/8	32
3/4"	H-61653W-VR	1/8	36
H-G165 Series			
Body Only • Install w/ (1) G-Union Fitting			
FIP Union × G-Thread 150 PSI CWP Max/180°F Max			
3/4" × 1"	H-G1653W	1/8	28

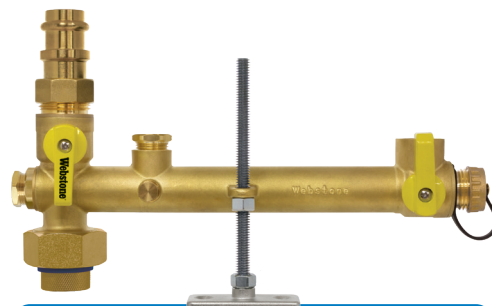

PRO-PAL WATER HEATER SUPPLY VALVE W/ EXPANSION TANK SERVICE

Full Port DZR Brass Ball w/ Union End w/ 3/4 Expansion Tank Port & Hi-Flow Hose Drain (3) Plugged FIP Ports (1/2", 1/2" & 1/8") • Includes Mounting Hardware

SIZE	ITEM#	LEAD-FREE BRASS	
		CTN/CASE	CASE WT
H-x265 Series			
FIP Union × FIP 150 PSI CWP Max/180°F Max			
3/4" × 1/2"	H-42652W	1/8	28
3/4"	H-42653W	1/8	28
FIP Union × MIP			
3/4" × 1/2"	H-22652W	1/8	28
3/4"	H-22653W	1/8	28
FIP Union × SWT			
3/4" × 1/2"	H-52652W	1/8	28
3/4"	H-52653W	1/8	28
FIP Union × Press			
3/4" × 1/2"	H-82652W	1/8	28
3/4"	H-82653W	1/8	28
FIP Union × Push			
3/4" × 1/2"	H-62652W	1/8	28
3/4"	H-62653W	1/8	29
H-x265-VR Series			
w/ Vacuum Relief Valve			
FIP Union × FIP 150 PSI CWP Max/180°F Max			
3/4" × 1/2"	H-42652W-VR	1/8	28
3/4"	H-42653W-VR	1/8	28
FIP Union × MIP			
3/4" × 1/2"	H-22652W-VR	1/8	28
3/4"	H-22653W-VR	1/8	28
FIP Union × SWT			
3/4" × 1/2"	H-52652W-VR	1/8	28
3/4"	H-52653W-VR	1/8	28
FIP Union × Press			
3/4" × 1/2"	H-82652W-VR	1/8	28
3/4"	H-82653W-VR	1/8	28
FIP Union × Push			
3/4" × 1/2"	H-62652W-VR	1/8	28
3/4"	H-62653W-VR	1/8	29
H-G265 Series			
Body Only • Install w/ (1) G-Union Fitting			
FIP Union × G-Thread 150 PSI CWP Max/180°F Max			
3/4" × 1"	H-G2653W	1/8	28

PRO-PAL DIELECTRIC WATER HEATER SUPPLY VALVE

Full Port DZR Brass Ball Valve w/ Dielectric Union End 1/2" FIP Vacuum Relief Valve Port (2) Plugged FIP Ports (1/2" & 1/8")

SIZE	ITEM#	LEAD-FREE BRASS	
		CTN/CASE	CASE WT
H-x166-VR Series			
w/ Vacuum Relief Valve			
FIP Union × FIP 150 PSI CWP Max/180°F Max			
3/4" × 1/2"	H-41662W-VR	1/16	33
3/4"	H-41663W-VR	1/16	40
FIP Union × MIP			
3/4" × 1/2"	H-21662W-VR	1/16	33
3/4"	H-21663W-VR	1/16	38
FIP Union × SWT			
3/4" × 1/2"	H-51662W-VR	1/16	33
3/4"	H-51663W-VR	1/16	38
FIP Union × Press			
3/4" × 1/2"	H-81662W-VR	1/16	33
3/4"	H-81663W-VR	1/16	39
FIP Union × Push			
3/4" × 1/2"	H-61662W-VR	1/16	34
3/4"	H-61663W-VR	1/16	40
H-G166 Series			
Body Only • Install w/ (1) G-Union Fitting			
FIP Union × G-Thread 150 PSI CWP Max/180°F Max			
3/4" × 1"	H-G1663W	1/16	29



PRO-PAL WATER HEATER SUPPLY VALVE

Full Port DZR Brass Ball Valve w/ Union End 1/2" FIP Vacuum Relief Valve Port (2) Plugged FIP Ports (1/2" & 1/8")

SIZE	ITEM#	LEAD-FREE BRASS	
		CTN/CASE	CASE WT
H-x266-VR Series			
w/ Vacuum Relief Valve			
FIP Union × FIP 150 PSI CWP Max/180°F Max			
3/4" × 1/2"	H-42662W-VR	1/16	34
3/4" × 3/4"	H-42663W-VR	1/16	34
FIP Union × MIP			
3/4" × 1/2"	H-22662W-VR	1/16	34
3/4" × 3/4"	H-22663W-VR	1/16	34
FIP Union × SWT			
3/4" × 1/2"	H-52662W-VR	1/16	34
3/4" × 3/4"	H-52663W-VR	1/16	34
FIP Union × Press			
3/4" × 1/2"	H-82662W-VR	1/16	34
3/4" × 3/4"	H-82663W-VR	1/16	35
FIP Union × Push			
3/4" × 1/2"	H-62662W-VR	1/16	35
3/4" × 3/4"	H-62663W-VR	1/16	36
H-G266 Series			
Body Only • Install w/ (1) G-Union Fitting			
FIP Union × G-Thread 150 PSI CWP Max/180°F Max			
3/4" × 1"	H-G2663W	1/16	30

WATER HEATER SERVICE VALVE KITS

- Your choice of hot and cold connection solutions all in one box
- Brass or dielectric connections to the appliance
- Compatible with 3/4" MIP expansion tanks up to 5 gallons



KITTYPE		DIELECTRIC APPLIANCE CONNECTIONS			BRASS APPLIANCE CONNECTIONS	
KIT FEATURES - All kits feature choice of lead-free hot & cold connection solution with dielectric or brass connections						
Cold Side Connection Solution						
Hot Side Connection Solution						
Connections	Size	ITEM#	ITEM#	ITEM#	ITEM#	ITEM#
		H-x165-DU Series	H-x165-DU-BV Series	H-x165-DUBV Series	H-x265-BUBV Series	H-x265-BBV Series
FIP Union x MIP	3/4"	H-21653W-DU	H-21653W-DU-BV	-	-	H-22653W-BBV
FIP Union x FIP	3/4"	-	H-41653W-DU-BV	-	H-42653W-BUBV	-
FIP Union x SWT	3/4"	H-51653W-DU	H-51653W-DU-BV	-	H-52653W-BUBV	-
FIP Union x Press	3/4"	H-81653W-DU	-	H-81653W-DUBV	H-82653W-BUBV	-
w/ Vacuum Relief Valve						
		H-x165-DU-VR Series	H-x165-DU-BV-VR Series	H-x165-DUBV-VR Series	H-x265-BUBV-VR Series	H-x265-BBV-VR Series
FIP Union x MIP	3/4"	H-21653W-DU-VR	H-21653W-DU-BV-VR	-	-	H-22653W-BBV-VR
FIP Union x FIP	3/4"	-	H-41653W-DU-BV-VR	-	H-42653W-BUBV-VR	-
FIP Union x SWT	3/4"	H-51653W-DU-VR	H-51653W-DU-BV-VR	-	H-52653W-BUBV-VR	-
FIP Union x Press	3/4"	H-81653W-DU-VR	-	H-81653W-DUBV-VR	H-82653W-BUBV-VR	-

TEMPERING SERVICE VALVE KITS

- 1/2" WHSV cold water tapping accommodates direct connection of the Water Heater Tempering Valve (WHTV)
- WHTV Mixes hot output with cold supply for greater effective hot water storage
- Allows water heater to be set at 140°F, minimizing risk of Legionella bacteria in the tank
- Adjustable temperature control limits output to 120°F to prevent risk of scalding

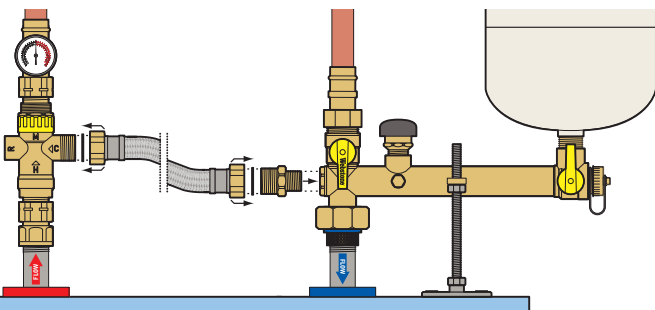

KITTYPE		DIELECTRIC APPLIANCE CONNECTIONS	BRASS APPLIANCE CONNECTIONS
KIT FEATURES - All kits feature choice of lead-free hot & cold connection solution with dielectric or brass connections			
Cold Side Connection Solution			
Hot Side Connection Solution			
Connections	Size	ITEM#	ITEM#
		H-x165-DTV Series	H-x265-BTV Series
FIP Union x MIP	3/4"	H-21653W-DTV	H-22653W-BTV
FIP Union x Press	3/4"	H-81653W-DTV	H-82653W-BTV
W/ VACUUM RELIEF VALVE			
		H-x165-DTV-VR Series	H-x265-BTV-VR Series
FIP Union x MIP	3/4"	H-21653W-DTV-VR	H-22653W-BTV-VR
FIP Union x Press	3/4"	H-81653W-DTV-VR	H-82653W-BTV-VR

UNIONS & DIELECTRIC PRODUCTS

PATENTED TECHNOLOGY

DIELECTRIC UNION

Galvanized Steel & Brass w/ Nylon Insulator Ring

SIZE	ITEM#	LEAD-FREE BRASS CTN/CASE	CASE WT
H-x110 Series			
FIP x MIP		200 PSI CWP Max/200°F Max	
3/4"	H-21103W	10/40	33
FIP x SWT		200 PSI CWP Max/200°F Max	
1/2"	H-01102W	24/144	48
3/4"	H-01103W	24/96	38
3/4" x 1/2"	H-01132W	24/96	38
1"	H-01104W	12/96	55
1 1/4"	H-01105W	6/48	43
1 1/2"	H-01106W	6/36	50
2"	H-01107W	6/18	47
LEAD-FREE BRASS			
FIP x Press		250 PSI CWP Max/180°F Max	
1/2"	H-81102W	30/120	46
3/4"	H-81103W	10/120	68
1"	H-81104W	24/48	27
1 1/4"	H-81105W	8/32	41
1 1/2"	H-81106W	6/24	40
2"	H-81107W	4/16	39



FORGED BRASS UNION

SIZE	ITEM#	LEAD-FREE BRASS CTN/CASE	CASE WT
H-x410 Series			
FIP Union x SWT		200 PSI CWP Max/200°F Max	
3/4"	H-54103W	20/100	35



FORGED DZR BRASS UNION

SIZE	ITEM#	LEAD-FREE BRASS CTN/CASE	CASE WT
H-x810 Series			
Press x F1960 PEX Union		200 PSI CWP Max/180°F Max	
1/2"	H-38102W	30/120	43
3/4"	H-38103W	30/120	64
1"	H-38104W	24/48	36
Press x F1807 PEX Union			
1/2"	H-18102W	30/120	42
3/4"	H-18103W	30/120	60
1"	H-18104W	24/48	33



DIELECTRIC UNION BALL

PRO-PAL DIELECTRIC UNION BALL

Full Port Forged DZR Brass Ball Valve w/ Galvanized Steel Union End, Nylon Insulator Ring, Reversible Handle & Dual Stem Seal Design

SIZE	ITEM#	LEAD-FREE BRASS CTN/CASE	CASE WT
H-x112 Series			
FIP Union x Press		250 PSI CWP Max/200°F Max	
1/2"	H-81122W	6/36	33
3/4"	H-81123W	4/24	30
1"	H-81124W	4/16	33
1 1/4"	H-81125W	3/12	42
1 1/2"	H-81126W	2/8	37
2"	H-81127W	2/4	27



DIELECTRIC UNION BALL DRAIN

PRO-PAL DIELECTRIC UNION BALL DRAIN

Full Port Forged DZR Brass Ball Valve w/ Galvanized Steel Union End, Nylon Insulator Ring, Hi-Flow Hose Drain, Reversible Handle & Dual Stem Seal Design

SIZE	ITEM#	LEAD-FREE BRASS CTN/CASE	CASE WT
H-x111 Series			
FIP Union x Press		250 PSI CWP Max/200°F Max	
1/2"	H-81112W	4/24	32
3/4"	H-81113W	4/24	40
1"	H-81114W	4/16	40
1 1/4"	H-81115W	2/8	31
1 1/2"	H-81116W	2/8	42
2"	H-81117W	2/4	32



UNION BALL

PRO-PAL UNION BALL

Full Port Forged DZR Brass Ball Valve w/ Single Union End & Adjustable Packing Gland

SIZE	ITEM#	LEAD-FREE BRASS CTN/CASE	CASE WT
H-x042 Series			
FIP Union x FIP		250 PSI CWP Max/200°F Max	
1/2"	H-40422W	5/40	35
3/4"	H-40423W	4/32	41
1"	H-40424W	4/20	37
1 1/4"	H-40425W	4/12	33
1 1/2"	H-40426W	2/8	30
FIP Union x SWT		250 PSI CWP Max/200°F Max	
1/2"	H-50422W	5/40	34
3/4"	H-50423W	4/32	40
1"	H-50424W	4/20	36
1 1/4"	H-50425W	4/12	33
1 1/2"	H-50426W	2/8	30
FIP Union x Press		250 PSI CWP Max/200°F Max	
1/2"	H-80422W	5/40	37
3/4"	H-80423W	4/32	43
1"	H-80424W	4/20	38
1 1/4"	H-80425W	4/12	35
1 1/2"	H-80426W	2/8	31
FIP Union x Push		200 PSI CWP Max/200°F Max	
1/2"	H-60422W	5/40	34
3/4"	H-60423W	4/32	38
1"	H-60424W	4/20	24
FIP Union x F1960 PEX		250 PSI CWP Max/200°F Max	
1/2"	H-30422W	5/40	35
3/4"	H-30423W	4/32	40
1"	H-30424W	4/20	37
FIP Union x F1807 PEX		250 PSI CWP Max/200°F Max	
1/2"	H-10422W	5/40	34
3/4"	H-10423W	4/32	39
1"	H-10424W	4/20	36



UNION BALL DRAIN

PRO-PAL UNION BALL DRAIN

Full Port Forged Brass Ball Valve w/ Single Union End, Hi-Flow Hose Drain, Reversible Handle & Adjustable Packing Glands

SIZE	ITEM#	LEAD-FREE BRASS CTN/CASE	CASE WT
H-x043 Series			
FIP Union x FIP		600 PSI CWP Max/350°F Max	
3/4"	H-40433W	6/24	40
1"	H-40434W	4/16	36
1 1/4"	H-40435W	2/12	38
1 1/2"	H-40436W	2/8	38
FIP Union x SWT		600 PSI CWP Max/250°F Max	
3/4"	H-50433W	6/24	39
1"	H-50434W	4/16	35
1 1/4"	H-50435W	2/12	38
1 1/2"	H-50436W	2/8	38
FIP Union x Press		250 PSI CWP Max/250°F Max	
3/4"	H-80433W	4/16	28
1"	H-80434W	2/16	37
1 1/4"	H-80435W	2/8	27
1 1/2"	H-80436W	1/5	25
LEAD-FREE BRASS			
FIP Union x F1960 PEX		250 PSI CWP Max/200°F Max	
1/2"	H-30432W	4/16	21
3/4"	H-30433W	4/16	27
1"	H-30434W	2/16	36
1 1/4"	H-30435W	2/8	27
1 1/2"	H-30436W	1/8	38
2"	H-30437W	1/4	28
FIP Union x F1807 PEX		250 PSI CWP Max/200°F Max	
1/2"	H-10432W	4/16	21
3/4"	H-10433W	4/16	26
1"	H-10434W	2/16	35
1 1/4"	H-10435W	2/8	26
1 1/2"	H-10436W	1/8	37
2"	H-10437W	1/4	27



TWH SERVICE VALVES **E·X·P** S E R I E S

THE **ONLY** WAY TO INSTALL ANY **TANKLESS** **WATER HEATER**

PATENTED TECHNOLOGY

SIMPLIFIES SERVICE

- Quicker, consistent quality installations
- Fewer leak paths
- Allows for one person diagnostic testing
- Full range of service valves styles, installation kits, and accessories
- Also for use with wall hung and combi boilers - see page 27
- EXP Complete kits include your choice of TWH service valves with pressure relief valve, integrated gas sediment trap, gas ball valve, and gas flex line

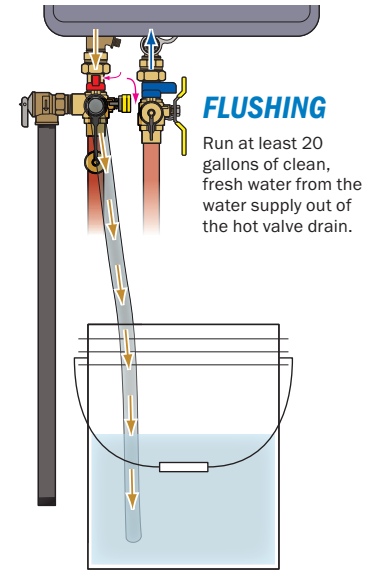
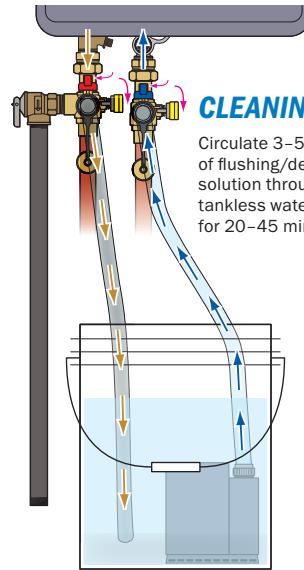

TWH SERVICE VALVES
E·X·P
COMPLETE



FULL RANGE OF SERVICE VALVES STYLES

TWH SERVICE VALVES
E·X·P
PREMIUM DESIGN



TWH SERVICE VALVES
E·X·P E2
SPACE SAVING



TWH SERVICE VALVES
E·X·P E3
ADJUSTABLE PRV PORT



TWH SERVICE VALVES
E·X·P
ULTRA-COMPACT

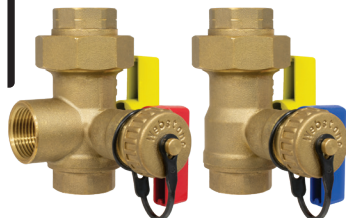

TWH SERVICE VALVES
E·X·P
UNION BALL

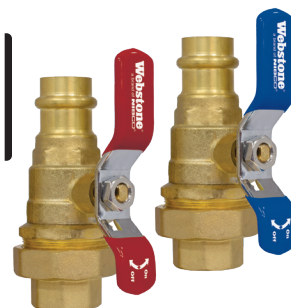

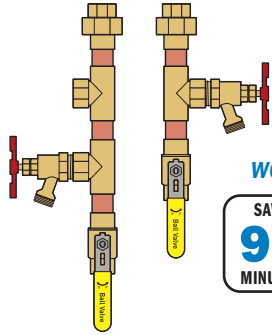

WORK SMARTER

SAVE **90** MINUTES

ELIMINATE **12** LEAK PATHS

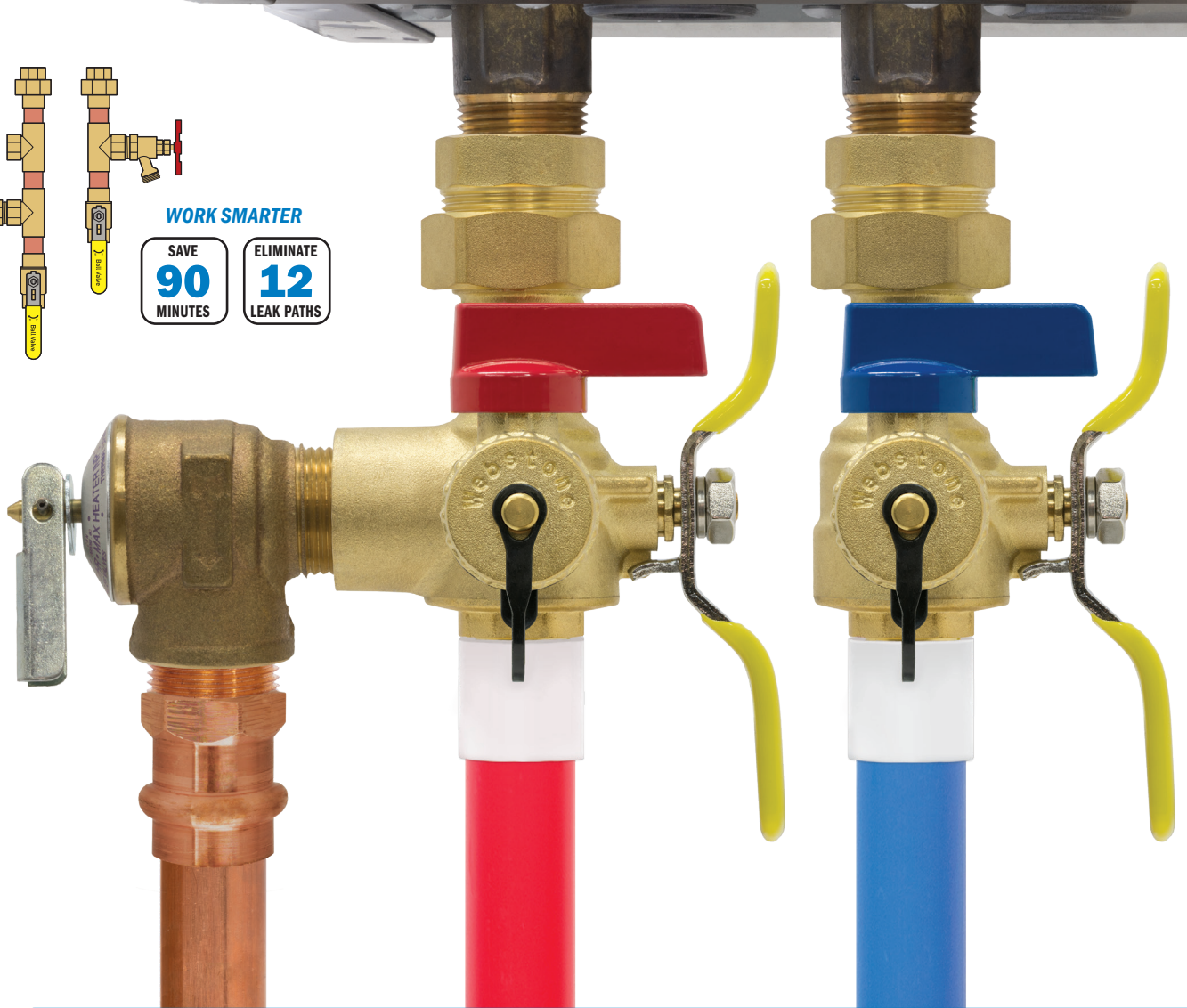

PRO-PAL
SERIES

UNION BALL DRAIN

SEE PAGE 45

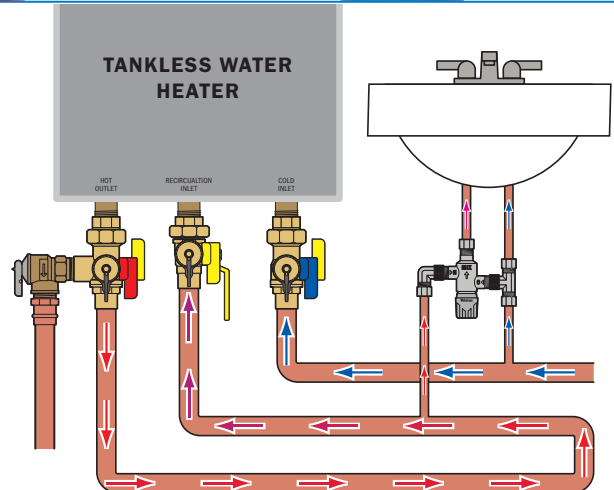

IDEAL FOR INTEGRATED RECIRCULATION PORT CONNECTIONS

E-X-P® TANKLESS WATER HEATER SOLUTIONS

TWH SERVICE VALVES
E·X·P
PREMIUM DESIGN

**PREMIUM
DESIGN**

E-X-P TANKLESS WATER HEATER SERVICE VALVE KIT

Hot & Cold Set of Full Port Forged Brass Ball Valves w/ Hi-Flow Hose Drains, Pressure Relief Valve Outlet & Adjustable Packing Glands

SIZE	ITEM#	LEAD-FREE BRASS CTN/CASE	CASE WT
H-x044 Series			
FIP Union × FIP			
3/4"	H-40443W	1/8	40
FIP Union × SWT			
3/4"	H-50443W	1/8	39
H-x044 Series			
w/ Lead-Free Residential Pressure Relief Valve			
FIP Union × FIP			
3/4"	H-40443WPR*	1/8	51
FIP Union × SWT			
3/4"	H-50443WPR*	1/8	51

*CERTIFICATIONS APPLY TO BASE MODEL H-x0443W



Installs in
30% less
space than
the E-X-P E2

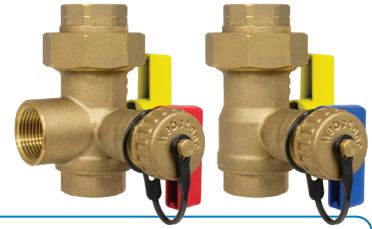

E-X-P ULTRA-COMPACT TANKLESS WATER HEATER SERVICE VALVE KIT

Hot & Cold Set of Full Port Forged DZR Brass Ball Valves w/ 3/4" Hose Drains & Pressure Relief Valve Outlet

SIZE	ITEM#	LEAD-FREE BRASS CTN/CASE	CASE WT
H-x244 Series			
FIP Union × FIP			
3/4"	H-42443W	1/12	36
FIP Union × SWT			
3/4"	H-52443W	1/12	35
FIP Union × F1960 PEX			
3/4"	H-32443W	1/12	36
FIP Union × F1807 PEX			
3/4"	H-12443W	1/12	35
H-x-G244 Series			
FIP Union × Press			
3/4"	H-8-G2443W	1/12	43
H-G244 Series			
FIP Union × G-Thread			
3/4" × 1"	H-G2444W-R	1/12	38
H-x244PR Series			
w/ Lead-Free Residential Pressure Relief Valve			
FIP Union × FIP			
3/4"	H-42443WPR	1/12	45
FIP Union × SWT			
3/4"	H-52443WPR	1/12	45
FIP Union × F1960 PEX			
3/4"	H-32443WPR	1/12	41
FIP Union × F1807 PEX			
3/4"	H-12443WPR	1/12	40
H-x244PR Series			
w/ Lead-Free Residential Pressure Relief Valve			
FIP Union × Press			
3/4"	H-8-G2443WPR	1/12	48
H-x244PR Series • w/ Lead-Free Residential PRV Bodies Only • Install w/ (2) G-Union Fittings			
FIP Union × G-Thread			
3/4" × 1"	H-G2444W-RPR	1/12	37

PEX, FIP, SWT SERVICE VALVES CERTIFIED TO

TWH SERVICE VALVES
E·X·P E2
SPACE SAVING

**SPACE
SAVING**



E-X-P E2 TANKLESS WATER HEATER SERVICE VALVE KIT

Hot & Cold Set of Full Port Forged Brass Ball Valves w/ Hi-Flow Hose Drains, Pressure Relief Valve Outlet, & Adjustable Packing Glands

SIZE	ITEM#	LEAD-FREE BRASS CTN/CASE	CASE WT
H-x444 Series			
FIP Union × FIP			
3/4"	H-44443W	1/10	31
1"	H-44444W	1/10	54
FIP Union × SWT			
3/4"	H-54443W	1/10	32
1"	H-54444W	1/10	54
FIP Union × Press			
3/4"	H-84443W	1/10	32
1"	H-84444W	1/10	58
FIP Union × Push			
3/4"	H-64443W	1/10	32
FIP Union × F1960 PEX			
3/4"	H-34443W	1/10	32
1"	H-34444W	1/10	33
FIP Union × F1807 PEX			
3/4"	H-14443W	1/10	31
1"	H-14444W	1/10	32
H-x444PR Series			
w/ Lead-Free Residential Pressure Relief Valve			
FIP Union × FIP			
3/4"	H-44443WPR	1/10	40
1"	H-44444WPR	1/10	65
FIP Union × SWT			
3/4"	H-54443WPR	1/10	42
1"	H-54444WPR	1/10	65
FIP Union × Press			
3/4"	H-84443WPR	1/10	36
1"	H-84444WPR	1/10	65
FIP Union × Push			
3/4"	H-64443WPR	1/10	36
FIP Union × F1960 PEX			
3/4"	H-34443WPR	1/10	38
1"	H-34444WPR	1/10	40
FIP Union × F1807 PEX			
3/4"	H-14443WPR	1/10	38
1"	H-14444WPR	1/10	38



SEE PAGES 4-7

Adjustable PRV
outlet ideal for
tight spaces

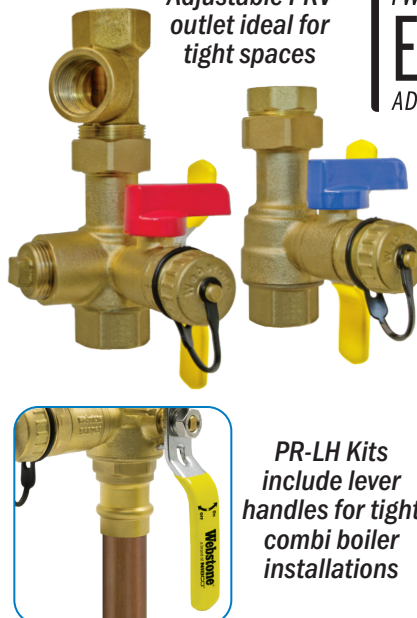

TWH SERVICE VALVES
E·X·P E3
ADJUSTABLE PRV PORT

**RECESSED
BOXES**

E-X-P E3 TANKLESS WATER HEATER SERVICE VALVE KIT

Hot & Cold Set of Full Port Forged Brass Ball Valves w/ Hi-Flow Hose Drains, Adjustable Pressure Relief Valve Outlet & Adjustable Packing Glands • Includes Residential Pressure Relief Valve

SIZE	ITEM#	LEAD-FREE BRASS CTN/CASE	CASE WT
H-x544 Series			
FIP Union × FIP			
3/4"	H-45443WPR	1/10	48
FIP Union × SWT			
3/4"	H-55443WPR	1/10	45
FIP Union × Press			
3/4"	H-85443WPR	1/10	48
H-x544-LH Series			
w/ Lever Handles			
FIP Union × FIP			
3/4"	H-45443WPR-LH*	1/10	48
FIP Union × SWT			
3/4"	H-55443WPR-LH*	1/10	48
FIP Union × Press			
3/4"	H-85443WPR-LH*	1/10	48

*CERTIFICATIONS APPLY TO BASE MODEL H-x4443W

PR-LH Kits
include lever
handles for tight
combi boiler
installations

E-X-P® TANKLESS WATER HEATER SOLUTIONS

SERVICE VALVE STYLE		E-X-P		E-X-P E2		E-X-P E3		E-X-P Ultra-Compact		E-X-P Union Ball	
Features - all kits include Hot & Cold Set of Full Port Forged Lead-Free Brass Ball Valves											
Pressure Relief Valve (PRV) Outlet		✓	✓	✓	✓	NONE	Adjustable	Adjustable	✓	✓	NONE
Lead-Free Residential PRV		-	✓	-	✓	-	✓	✓	-	✓	-
Hose Drains		Hi-Flow	Hi-Flow	Hi-Flow	Hi-Flow	Hi-Flow	Hi-Flow	Hi-Flow	✓	✓	-
Handle Style		Wing	Wing	Wing	Wing	Wing	Lever	Lever	Compact Lever	Compact Lever	Wing
Stem Seals		Adjustable	Adjustable	Adjustable	Adjustable	Adjustable	Adjustable	Adjustable	Double O-Ring	Double O-Ring	Adjustable
Connections	Size	ITEM#	ITEM#	ITEM#	ITEM#	ITEM#	ITEM#	ITEM#	ITEM#	ITEM#	ITEM#
FIP Union × FIP	3/4"	H-40443W	H-40443WPR	H-44443W	H-44443WPR	H-44063W	H-45443WPR	H-45443WPR-LH	H-42443W	H-42443WPR	H-40423W-RB
	1"	-	-	H-44444W	H-44444WPR	-	-	-	-	-	-
FIP Union × SWT	3/4"	H-50443W	H-50443WPR	H-54443W	H-54443WPR	H-54063W	H-55443WPR	H-55443WPR-LH	H-52443W	H-52443WPR	H-50423W-RB
	1"	-	-	H-54444W	H-54444WPR	-	-	-	-	-	-
FIP Union × Press	3/4"	-	-	H-84443W	H-84443WPR	H-84063W	H-85443WPR	H-85443WPR-LH	H-8-G2443W	H-8-G2443WPR	H-80423W-RB
	1"	-	-	H-84444W	H-84444WPR	-	-	-	-	-	-
FIP Union × Push	3/4"	-	-	H-64443W	H-64443WPR	H-64063W	-	-	-	-	-
FIP Union × F1960 PEX	3/4"	-	-	H-34443W	H-34443WPR	H-34063W	-	-	H-32443W	H-32443WPR	H-30423W-RB
	1"	-	-	H-34444W	H-34444WPR	-	-	-	-	-	-
FIP Union × F1807 PEX	3/4"	-	-	H-14443W	H-14443WPR	H-14063W	-	-	H-12443W	H-12443WPR	H-10423W-RB
	1"	-	-	H-14444W	H-14444WPR	-	-	-	-	-	-
FIP Union × G-Thread	3/4" × 1"	-	-	-	-	-	-	-	H-G2444W-R	H-G2444W-RPR	-

E-X-P OPTIONS FOR NEXT GENERATION TANKLESS SOLUTIONS



NO PRV PORT MODELS FOR APPLIANCES WITH INTEGRATED PRV PORTS.



FOR APPLIANCES WITH INTEGRATED PRV & DRAIN PORTS



E-X-P E2 TANKLESS WATER HEATER SERVICE VALVE KIT

Hot & Cold Set of Full Port Forged DZR Brass Ball Valves w/ Hi-Flow Hose Drains & Adjustable Packing Glands

SIZE	ITEM#	LEAD-FREE BRASS CTN/CASE	CASE WT
H-x406 Series			
FIP Union × FIP		500 PSI CWP Max/200°F Max	
3/4"	H-44063W	1/10	15
FIP Union × SWT		500 PSI CWP Max/200°F Max	
3/4"	H-54063W	1/10	16
FIP Union × Press		250 PSI CWP Max/200°F Max	
3/4"	H-84063W	1/10	30
FIP Union × Push		200 PSI CWP Max/200°F Max	
3/4"	H-64063W	1/10	30
FIP Union × F1960 PEX		400 PSI CWP Max/200°F Max	
3/4"	H-34063W	1/10	30
FIP Union × F1807 PEX		400 PSI CWP Max/200°F Max	
3/4"	H-14063W	1/10	30

Also perfect for traditional tank water heater connections

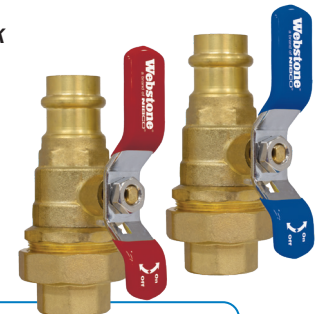
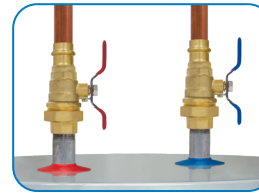

E-X-P UNION BALL TANKLESS WATER HEATER SERVICE VALVE KIT

Hot & Cold Set of Full Port Forged DZR Brass Ball Valves w/ Union Ends & Adjustable Packing Glands,

SIZE	ITEM#	LEAD-FREE BRASS CTN/CASE	CASE WT
H-x042-RB Series			
FIP Union × FIP		250 PSI CWP Max/200°F Max	
3/4"	H-40423W-RB	1/12	31
FIP Union × SWT			
3/4"	H-50423W-RB	1/12	31
FIP Union × Press			
3/4"	H-80423W-RB	1/12	33
FIP Union × F1960 PEX			
3/4"	H-304.23W-RB	1/12	31
FIP Union × F1807 PEX			
3/4"	H-10423W-RB	1/12	30

E-X-P ACCESSORIES



E-X-P PRESSURE RELIEF VALVE RELOCATION ADAPTER

For Recessed Boxes, Tight or Unique Installations

SIZE	ITEM#	LEAD-FREE BRASS CTN/CASE	CASE WT
Fits E-X-P E2			
3/4"	H-28023W	10/100	59



PRESSURE RELIEF VALVES

SIZE	ITEM#	STANDARD BRASS CTN/CASE	CASE WT
H-2071 Series			
Commercial Grade Pressure Relief Valve & Close Nipple			
MIP × FIP		150 PSI CWP Max/ 2.7M BTU/HR	
3/4"	H-20723-CN†	1/10	15
LEAD-FREE BRASS			
SIZE	ITEM#	CTN/CASE	CASE WT
H-2071 Series			
Residential Pressure Relief Valve			
MIP × FIP		150 PSI CWP Max / 1.163M BTU/HR	
3/4"	H-20713W*	1/100	46
H-2071 Series			
Boiler Pressure Relief Valve			
MIP × FIP		30 PSI CWP Max/423,600 BTU/HR	
3/4"	H-20733W‡	1/100	46

CERTIFICATION APPLIES TO CASH ACME *FWL-2F, †F-82, ‡F-30F

TWH SERVICE VALVES E·X·P® COMPLETE

PATENTED TECHNOLOGY WITH
FURTHER PATENTS PENDING

- Kits include your choice of TWH service valves with pressure relief valve, integrated gas sediment trap, gas ball valve, and gas flex line
- Results in cleaner looking, consistent quality, more professional installations
- Saves labor and eliminates repetitive field fabrication
- Reduces leak paths

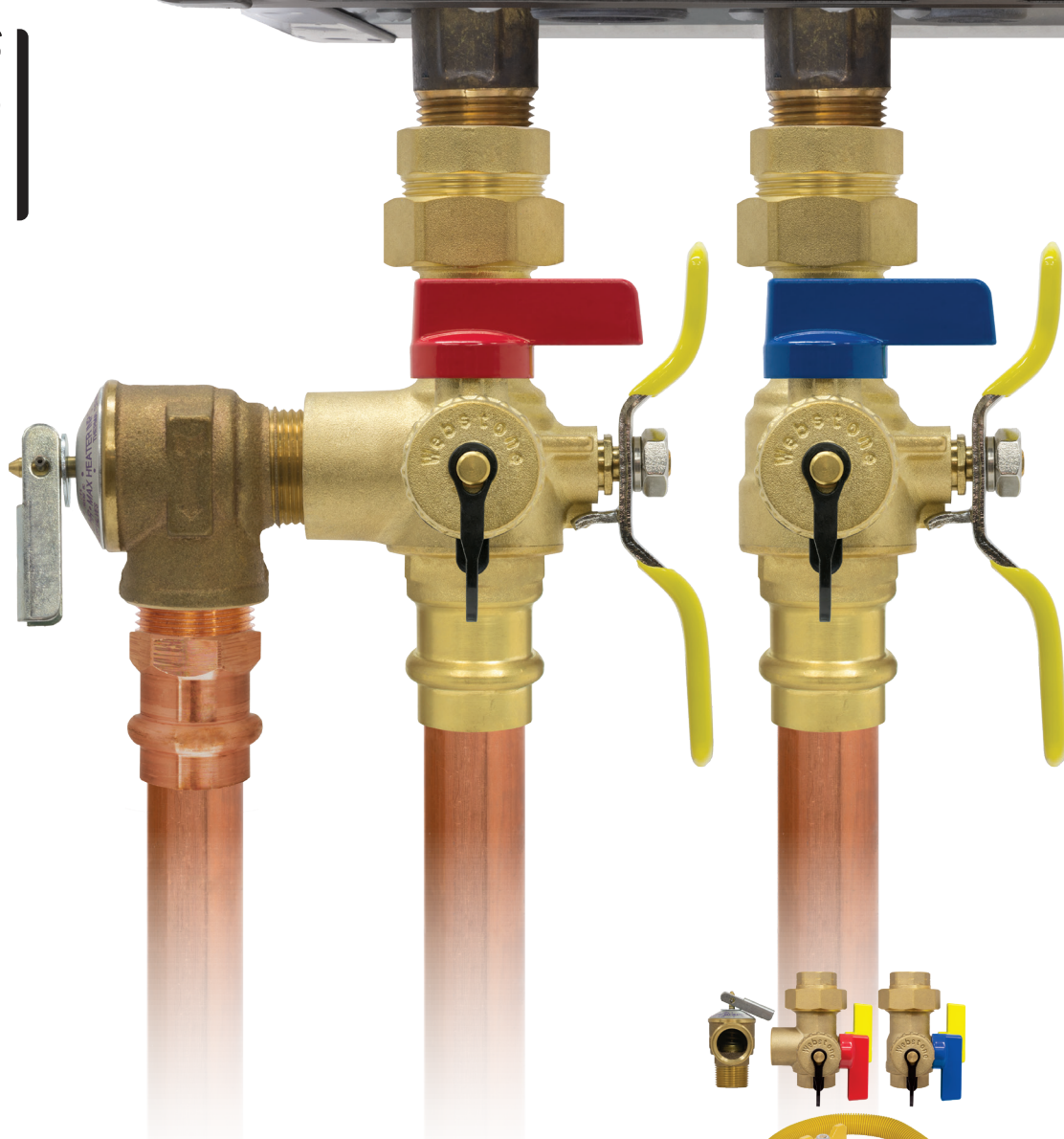

TWH SERVICE VALVES E·X·P® ULTRA-COMPACT

E-X-P COMPLETE TANKLESS WATER HEATER INSTALLATION KIT

Includes E-X-P E2 Service Valves w/ Lead-Free Residential Pressure Relief Valve (150 PSI / 1.163M BTU/HR) & 3/4" FIP Full Port Forged Brass Gas Sediment Trap w/ 3/4" FIP Gas Ball Valve & 24" Flex Line

SIZE	ITEM#	LEAD-FREE BRASS CTN/CASE	CASE WT
H-x444-GST Series			
FIP Union × FIP		500 PSI CWP Max/210°F Max	
3/4"	H-44443WPR-GST	1/4	29
FIP Union × SWT		500 PSI CWP Max/210°F Max	
3/4"	H-54443WPR-GST	1/4	30
FIP Union × Press		250 PSI CWP Max/250°F Max	
3/4"	H-84443WPR-GST	1/4	28
LEAD-FREE BRASS			
FIP Union × Push		200 PSI CWP Max/200°F Max	
3/4"	H-64443WPR-GST	1/4	28
FIP Union × F1960 PEX		400 PSI CWP Max/200°F Max	
3/4"	H-34443WPR-GST	1/4	29
FIP Union × F1807 PEX		400 PSI CWP Max/200°F Max	
3/4"	H-14443WPR-GST	1/4	29

GAS COMPONENTS RATED AT 1/2 PSI MAX/149°F MAX

TWH SERVICE VALVES E·X·P® E2 SPACE SAVING



E-X-P COMPLETE TANKLESS WATER HEATER INSTALLATION KIT

Includes E-X-P Ultra Compact Service Valves w/ Lead-Free Residential Pressure Relief Valve (150 PSI / 1.163M BTU/HR) & 3/4" FIP Full Port Forged Brass Gas Sediment Trap w/ 3/4" FIP Gas Ball Valve & 24" Flex Line

SIZE	ITEM#	LEAD-FREE BRASS CTN/CASE	CASE WT
H-x244-GST Series			
FIP Union × FIP		250 PSI CWP Max/200°F Max	
3/4"	H-42443WPR-GST	1/4	26
FIP Union × SWT			
3/4"	H-52443WPR-GST	1/4	26
FIP Union × F1960 PEX			
3/4"	H-32443WPR-GST	1/4	22
FIP Union × F1807 PEX			
3/4"	H-12443WPR-GST	1/4	21
H-x-G244-GST Series			
FIP Union × Press		200 PSI CWP Max/200°F Max	
3/4"	H-8-G2443WPR-GST	1/4	24
H-G244-GST Series			
Bodies Only • Install w/ (2) G-Union Fittings			
FIP Union × G-Thread		200 PSI CWP Max/200°F Max	
3/4" × 1"	H-G2444W-R-PR-GST	1/4	22

GAS COMPONENTS RATED AT 1/2 PSI MAX/149°F MAX

PEX, FIP, SWT SERVICE VALVES CERTIFIED TO

GAS SEDIMENT TRAP

PATENTS PENDING

THE **CLEANEST** WAY TO INSTALL **GAS** APPLIANCES

- 1/2" & 3/4" sizes cover most installation needs
- Includes full port gas ball valve
- Available w/ 24" gas flex line
- Results in cleaner looking, consistent quality, more professional installations
- Eliminates repetitive field fabrication
- Saves labor
- Reduces leak paths

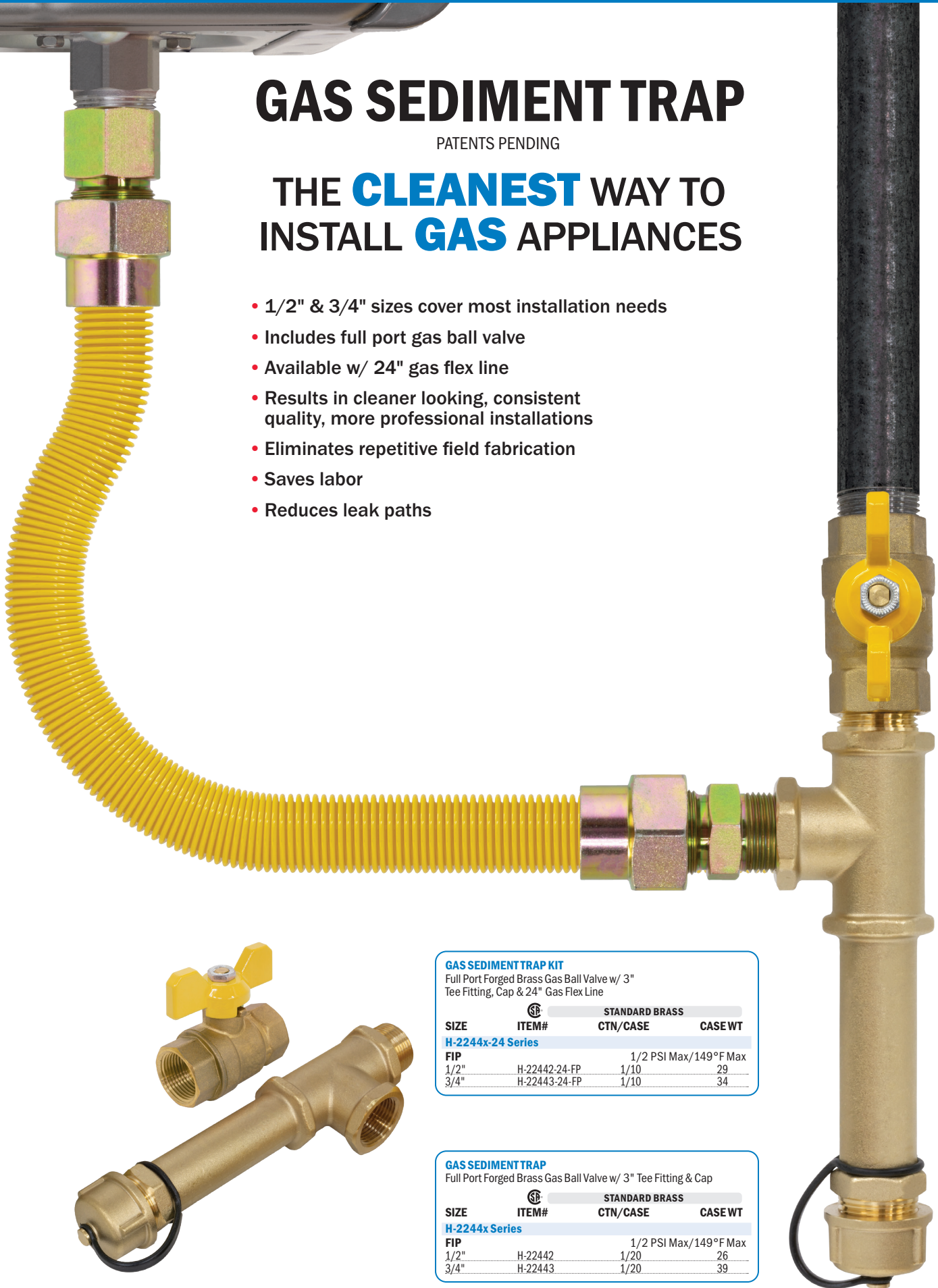

GAS SEDIMENT TRAP KIT

Full Port Forged Brass Gas Ball Valve w/ 3" Tee Fitting, Cap & 24" Gas Flex Line

SIZE	ITEM#	STANDARD BRASS CTN/CASE	CASE WT
H-2244x-24 Series			
FIP		1/2 PSI Max/149°F Max	
1/2"	H-22442-24-FP	1/10	29
3/4"	H-22443-24-FP	1/10	34

GAS SEDIMENT TRAP

Full Port Forged Brass Gas Ball Valve w/ 3" Tee Fitting & Cap

SIZE	ITEM#	STANDARD BRASS CTN/CASE	CASE WT
H-2244x Series			
FIP		1/2 PSI Max/149°F Max	
1/2"	H-22442	1/20	26
3/4"	H-22443	1/20	39

UNDER BOILER SOLUTIONS

A **SINGLE SOURCE** FOR
BETTER **INSTALLATIONS**

- Saves time, space, and labor
- Maintains system efficiency
- Simplifies future maintenance
- Full-featured installations require no more than 22"
- Innovative solutions available for external pumps and combi DHW connections

AIR SEPARATOR

Reduces noise and improves system operation - SEE PAGE 31

MAGNETIC BOILER FILTER

High-powered magnet captures ferrous debris - SEE PAGE 34

HYDRO-CORE MANIFOLD

Avoids precise calculations and costly field fabrication - SEE PAGE 25

DIFFERENTIAL PRESSURE BY-PASS VALVE

Eliminates noise in a zoned hydronic system with fixed-speed primary circulator pump - SEE PAGE 29

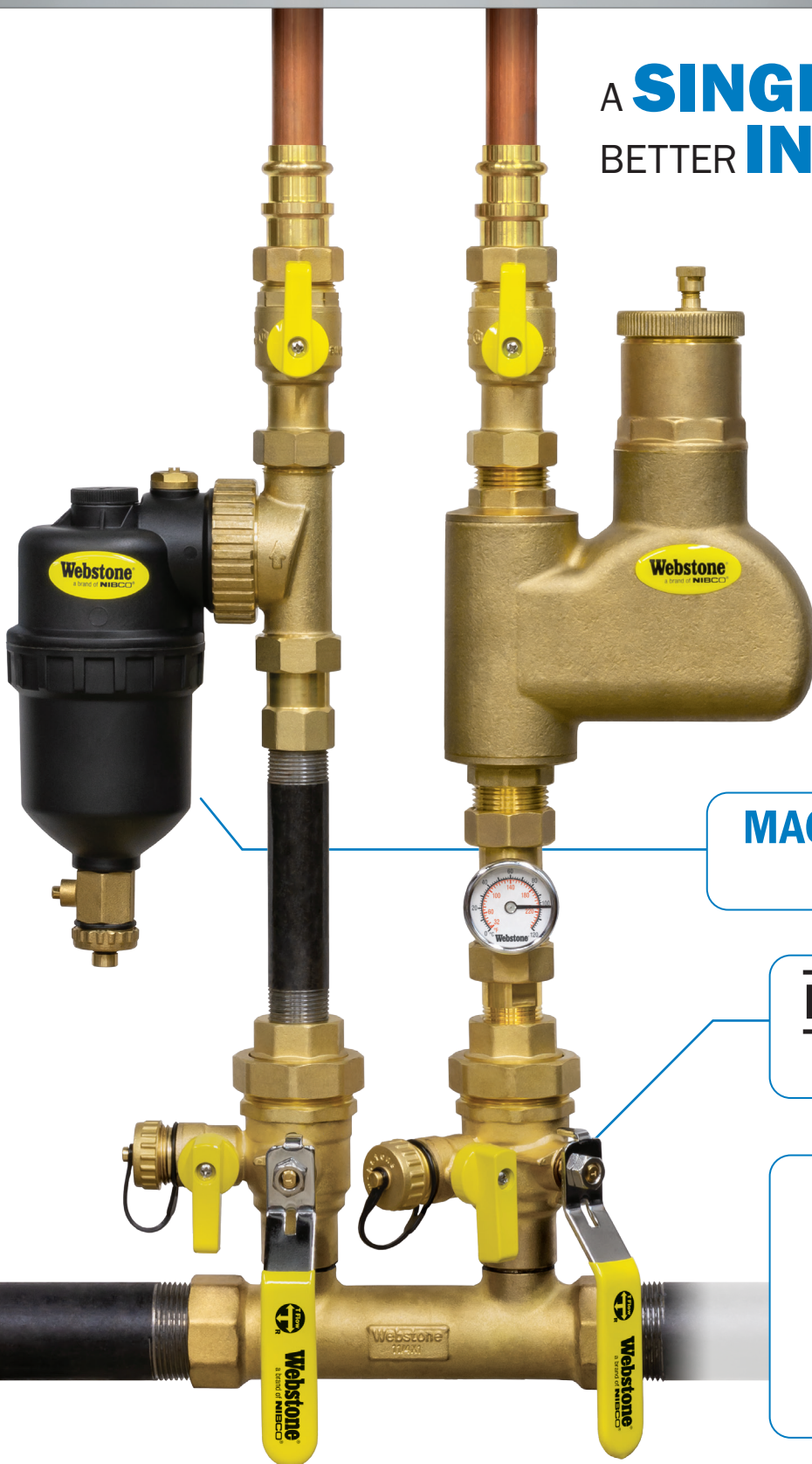

HYDRO-CORE

PATENTED TECHNOLOGY

THE **CORE** OF ANY
PROFESSIONAL **HYDRONIC**
INSTALLATION

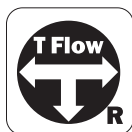

T-FLOW BALL
Directs flow into
either the boiler
or purge drain

WORK SMARTER

SAVE
90
MINUTES

ELIMINATE
12
LEAK PATHS

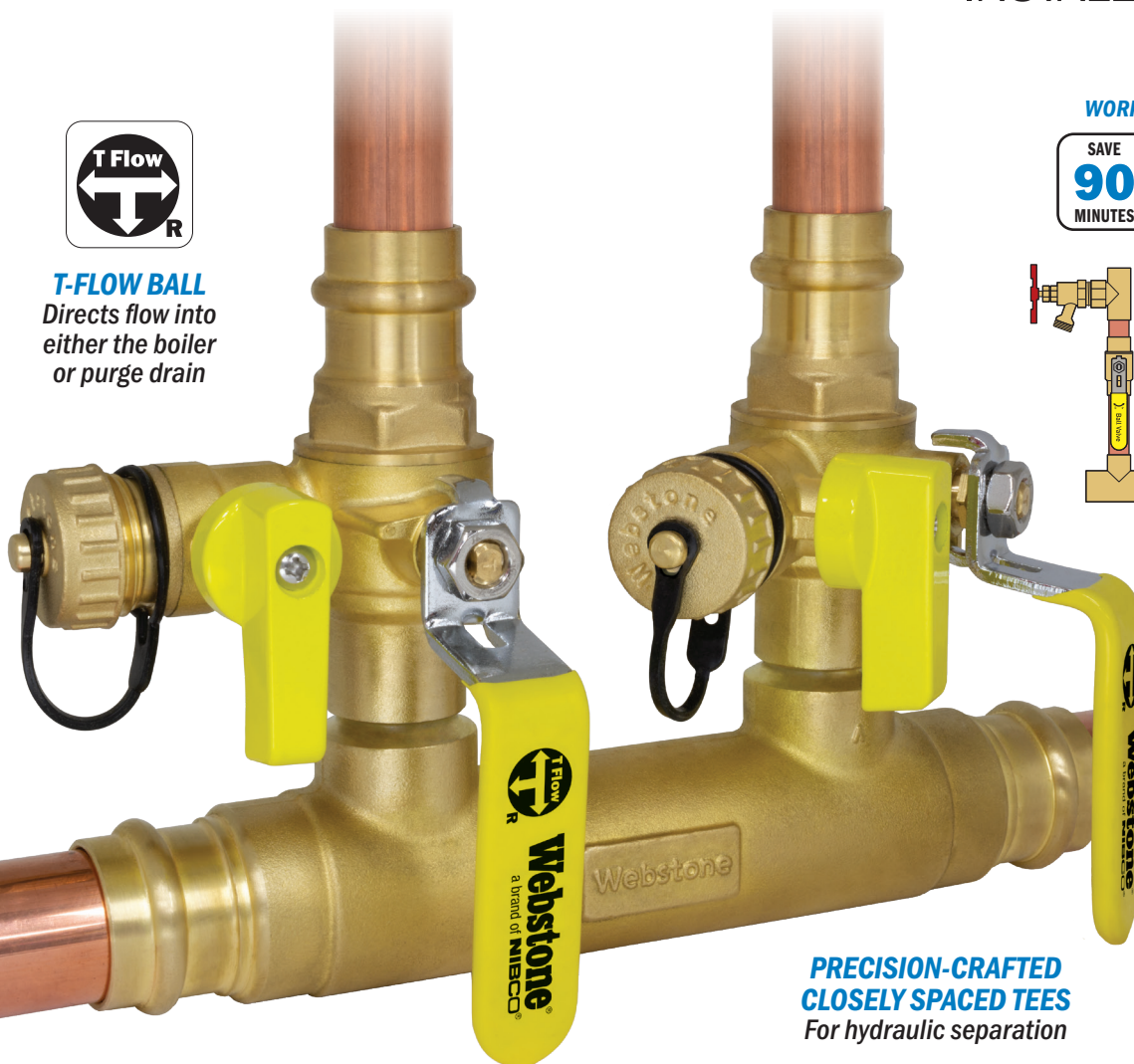
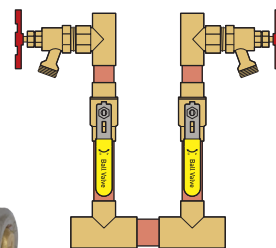

**PRECISION-CRAFTED
CLOSELY SPACED TEES**
For hydraulic separation

The Hydro-Core Manifold is the ideal solution for near boiler piping or secondary loops.

- Integrated all-press design saves even more space and eliminates leak paths
- Eliminates costly field fabrication
- Avoids precise calculations
- Simplifies future maintenance
- All with EXPERT looking results

HYDRO-CORE MANIFOLD

Closely Spaced Tees w/ (2) Full Port Ball Valves, Hi-Flow Hose Drains & Adjustable Packing Glands

SIZE	ITEM#	STANDARD BRASS	
		CTN/CASE	CASE WT
H-x165 Series			
Press Run × Press Valve		250 PSI CWP Max/250°F Max	
1"×3/4"	H-88343-2	1/6	27
1"×1"	H-88344-2	1/6	32
1 1/4"×1"	H-88354-2	1/6	33
1 1/4"×1 1/4"	H-88355-2	1/6	44

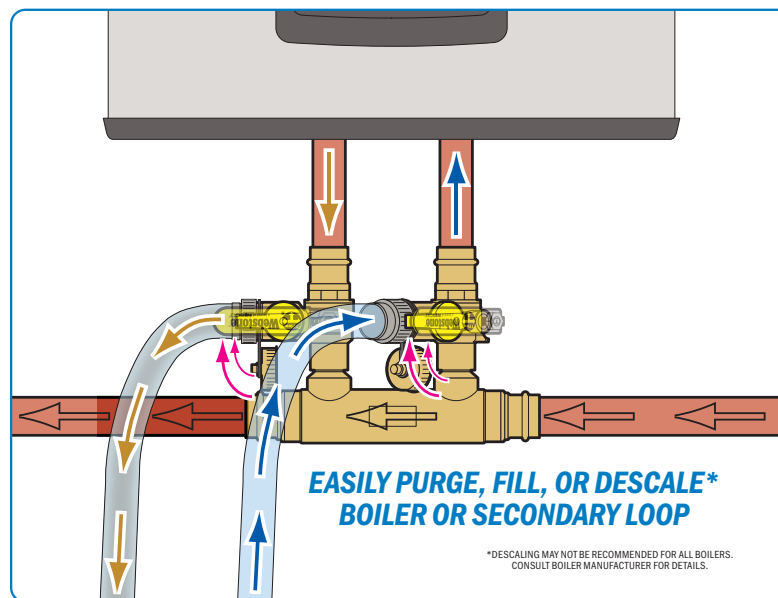

*DESCALING MAY NOT BE RECOMMENDED FOR ALL BOILERS. CONSULT BOILER MANUFACTURER FOR DETAILS.

UNDER BOILER SOLUTIONS

HYDRO-CORE

MANIFOLD W/UNION CONNECTIONS

Flexible, customizable design combines your choice of union and flange connections to accommodate different installation needs.

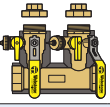
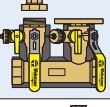
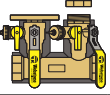
Manifold Design	System Run	Boiler Connection	Hydro-Core Union	FIP	SWT	Press x FIP
 H-HCM-DBD Series Double Ball Drain	1 1/4"	3/4"	1"	H-48354-43	H-58354-53	H-88354-43
	1 1/4"	1"	1"	H-48354-44	H-58354-54	H-88354-44
 H-HCM-RGHT Series Flange Right	1 1/4"	3/4"	1"	H-48754-43	H-58754-53	H-88754-43
	1 1/4"	1"	1"	H-48754-44	H-58754-54	H-88754-44
	1 1/2"	1 1/4"	1 1/4"	H-48765-45	H-58765-55	H-88765-45
 H-HCM-LEFT Series Flange Left	1 1/4"	3/4"	1"	H-48854-43	H-58854-53	H-88854-43
	1 1/4"	1"	1"	H-48854-44	H-58854-54	H-88854-44
	1 1/2"	1 1/4"	1 1/4"	H-48865-45	H-58865-55	H-88865-45

FULLY-INSULATED BODY
Custom-fit foam insulation maximizes system efficiency

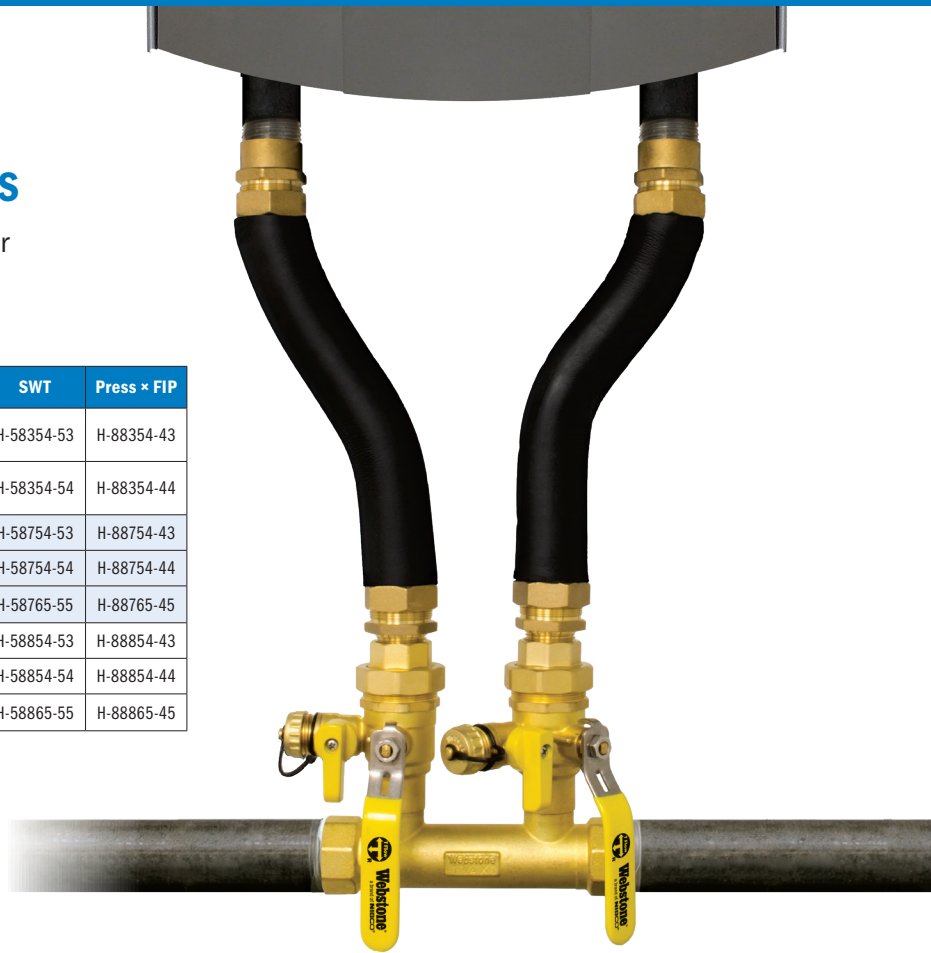

HYDRO-CORE

COMPLETE NEAR BOILER PIPING KITS

A fully-fabricated solution, kits include everything necessary for a successful installation.

- Choice of Press, FIP or SWT Hydro-Core Manifold
- Integrated connections for your specific boiler
- Assembled with copper or flexible stainless steel tubing
- Insulated manifold, supply & return lines

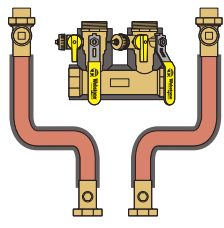
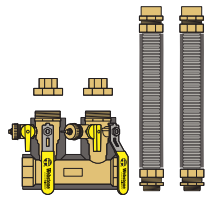
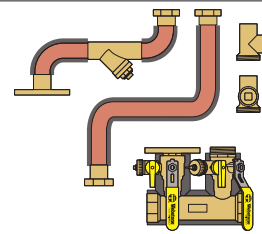
Complete Near Boiler Piping Kits			
	H-HC-CNBPK Series	H-HC-CNBPK Series	H-HC-CNBPK Series
			
SYSTEM PIPING	ITEM#	ITEM#	ITEM#
FIP	H-4CC4-NBHK	H-4FK4-WIF	H-4CCL54-54Y
SWT	H-5CC4-NBHK	H-5FK4-WIF	H-5CCL54-54Y
PRESS	H-8CC4-NBHK	H-8FK4-WIF	H-8CCL54-54Y
Kit Features			
SYSTEM RUN	1 1/4"	1 1/4"	1 1/4"
BOILER CONNECTION	1"	1"	1"
MANIFOLD TYPE	Double Ball Drain	Double Ball Drain	Flange Left
SUPPLY & RETURN PIPING	Bent Copper	12" Flexible Stainless Steel	Bent Copper
FULLY INSULATED	✓	✓	✓
3/4" FIP DEVICE PORTS	-	-	✓
MESH Y-STRAINER	-	-	✓

FIND THE RIGHT KIT FOR YOUR BOILER:

See webstonevalves.com/hydrocore for a full boiler compatibility chart

HYDRO-CORE

UNION CONNECTIONS

Join mixed piping types, add a gauge, or connect devices to your Hydro-Core installation.

HYDRO-CORE UNION CONNECTION

SIZE	ITEM#	STANDARD BRASS	
		CTN/CASE	CASE WT
H-HC-UN Series			
Hydro-Core Union x FIP 600 PSI CWP Max			
1" x 3/4"	H-HCE4-43	6/24	14
1" x 1"	H-HCE4-44	6/24	11
1" x 3/4"	H-HCE4-53	6/24	12
1" x 1"	H-HCE4-54	6/24	11
Hydro-Core Union x FIP 600 PSI CWP Max			
1 1/4" x 1"	H-HCE5-44	6/24	20
1 1/4" x 1 1/4"	H-HCE5-45	6/24	16
1 1/4" x 1"	H-HCE5-54	6/24	17
1 1/4" x 1 1/4"	H-HCE5-55	6/24	18



HYDRO-CORE UNION CONNECTION

w/ Multiple Device Ports • Plugged Connections for (2) 3/4" Devices or (1) 3/4" Device & (1) 1/4" Pressure Gauge

SIZE	ITEM#	STANDARD BRASS	
		CTN/CASE	CASE WT
H-HC-UN Series			
Hydro-Core Union x SWT 600 PSI CWP Max			
1" x 1"	H-HCE4-94	6/24	27



HYDRO-CORE UNION CONNECTION

w/ 1/4" NPT Gauge Port (Plugged)

SIZE	ITEM#	STANDARD BRASS	
		CTN/CASE	CASE WT
H-HC-UN Series			
Hydro-Core Union x FIP 600 PSI CWP Max			
1" x 3/4"	H-HCE4-63	6/24	25
1" x 1"	H-HCE4-64	6/24	22
Hydro-Core Union x SWT 600 PSI CWP Max			
1" x 1"	H-HCE4-74	6/24	19
1 1/4" x 1"	H-HCE5-74	6/24	27
1 1/4" x 1 1/4"	H-HCE5-75	6/24	27



BOILER SERVICE VALVES E·X·P SERIES

WALL HUNG & COMBI BOILER INSTALLATIONS

PATENTED TECHNOLOGY

PRO-PAL UNION BALL DRAIN

Full Port Forged Brass Ball Valve w/ Single Union End, Hi-Flow Hose Drain, Reversible Handle & Adjustable Packing Glands

SIZE	STANDARD BRASS			LEAD-FREE BRASS		
	ITEM#	CTN/CASE	CASE WT	ITEM#	CTN/CASE	CASE WT
H-x444 Series						
FIP Union x FIP 500 PSI CWP Max						
1"	H-44444	1/10	54	H-44444W	1/10	54
FIP Union x SWT 500 PSI CWP Max						
1"	-	-	-	H-54444W	1/10	54
FIP Union x Press 250 PSI CWP Max/250°F Max						
1"	-	-	-	H-84444W	1/10	58
H-x444PR3 Series						
Includes Boiler Pressure Relief Valve (30 PSI/423,600 BTU/HR)						
FIP Union x FIP 500 PSI CWP Max/210°F Max						
1"	H-44444PR3	1/10	65	H-44444WPR3	1/10	65
FIP Union x SWT 500 PSI CWP Max/210°F Max						
1"	-	-	-	H-54444WPR3	1/10	65
FIP Union x Press 250 PSI CWP Max/250°F Max						
1"	-	-	-	H-84444WPR3	1/10	65

Save space, simplify maintenance, and eliminate leak paths utilizing an E-X-P kit for wall hung or combi boiler installations.

E-X-P TANKLESS WATER HEATER KITS ARE IDEAL FOR COMBI BOILER DHW CONNECTIONS - SEE PAGE 18

PR3 KITS
Include 30 PSI/423,600 BTU/HR Pressure Relief Valve for Boiler/Hydronic Applications

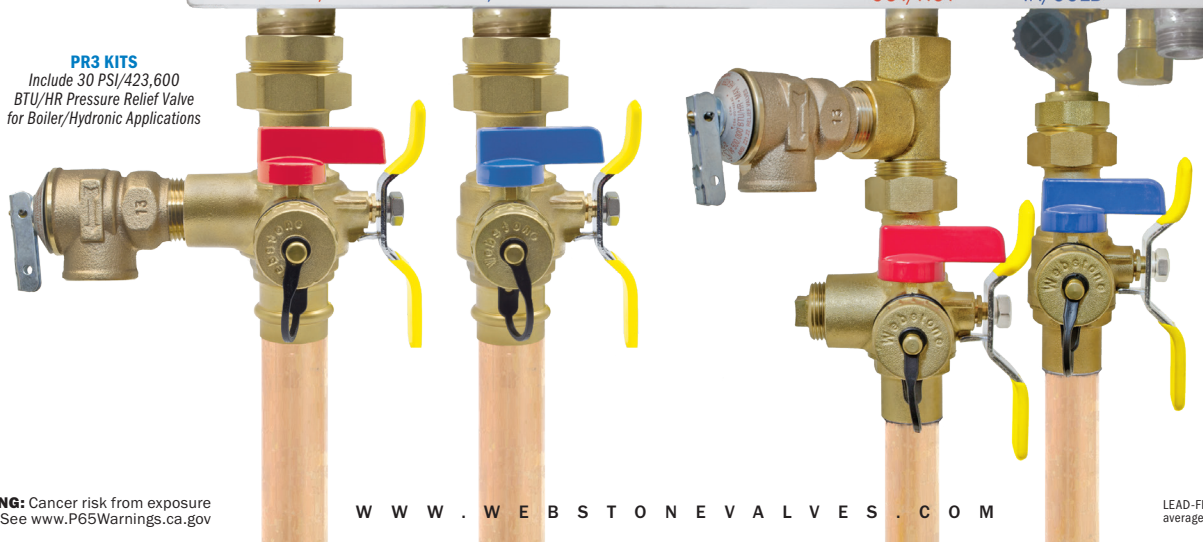

HYDRAULIC SEPARATOR

PATENTED TECHNOLOGY

A SMARTER SOLUTION FOR SYSTEM EFFICIENCY

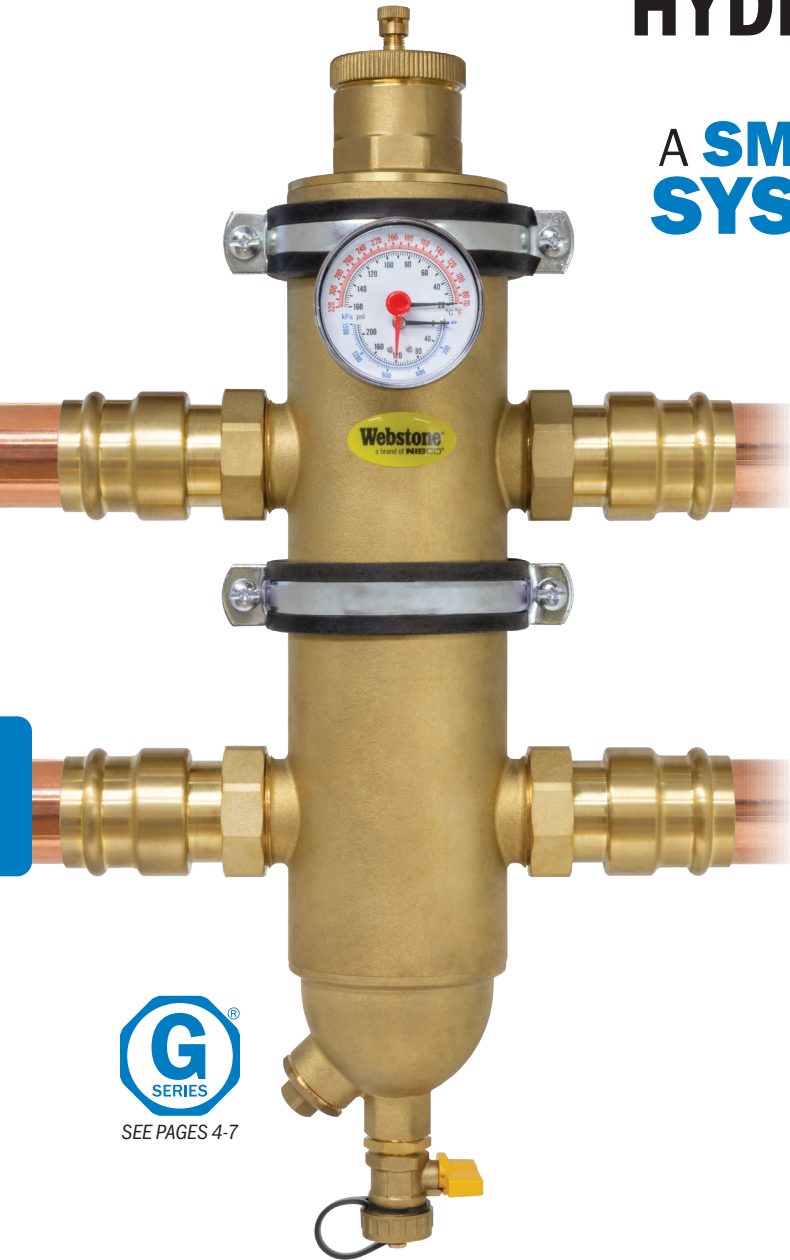

- Ensures ongoing system performance and efficiency
- Balances flow between primary and secondary piping
- Protects system from ferrous and non-ferrous debris
- Captures and removes air bubbles
- Includes high-powered magnet and dual-scale temperature/pressure gauge
- Mounting brackets and hardware included

COMBINES MULTIPLE SYSTEM COMPONENTS

INCLUDES MOUNTING BRACKETS & HARDWARE



SEE PAGES 4-7

FORGED BRASS HYDRAULIC SEPARATOR

w/ Integral Magnet & Stainless Steel Mesh, Integrated Hose Drain Valve, Air Separator & Filter • Dual Scale Temperature & Pressure Gauge • Includes Mounting Hardware

SIZE	ITEM#	STANDARD BRASS CTN/CASE	CASE WT
H-7x40 Series			
FIP			
1"	H-74404	1/1	17
1 1/4"	H-74405	1/1	17
1 1/2"	H-74406	1/1	17
MIP			
1"	H-72404	1/1	17
1 1/4"	H-72405	1/1	17
1 1/2"	H-72406	1/1	17
SWT			
1"	H-75404	1/1	17
1 1/4"	H-75405	1/1	17
1 1/2"	H-75406	1/1	17
Press			
1"	H-78404	1/1	17
1 1/4"	H-78405	1/1	17
1 1/2"	H-78406	1/1	17

H-7040 Series

Body Only • Install w/ (2) G-Union Fittings

G-Thread	ITEM#	STANDARD BRASS CTN/CASE	CASE WT
1 1/2"	H-7G406	1/1	16

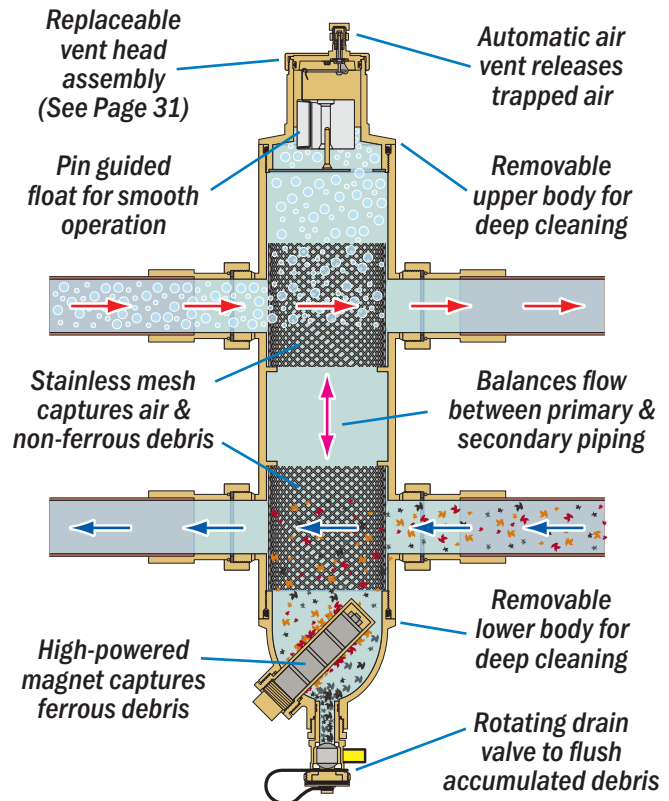



PRO-PAL
SERIES

PURGE TEE™

PURGETEE

Full Port Forged Brass Ball Valve w/ Reversible Handle & Adjustable Packing Gland

SIZE	ITEM#	STANDARD BRASS CTN/CASE	CASE WT
H-x864 Series			
SWT Run × SWT		600 PSI CWP Max/250°F Max	
1" × 3/4"	H-58643	1/12	23
1" × 1"	H-58644	1/12	25
1 1/4" × 3/4"	H-58653	1/12	39
1 1/4" × 1"	H-58654	1/12	38
1 1/4" × 1 1/4"	H-58655	1/12	37
Press Run × Press		250 PSI CWP Max/250°F Max	
1" × 3/4"	H-88643	1/12	34
1" × 1"	H-88644	1/12	34
1 1/4" × 1"	H-88654	1/12	51
1 1/4" × 1 1/4"	H-88655	1/12	52

WORK SMARTER*

SAVE
35
MINUTES

ELIMINATE
4
LEAK PATHS



*Correct spacing for hydraulic separation cannot be achieved using off-the-shelf components.

POWER PURGING
Fluid is rapidly forced through the secondary loop, purging excess air from system through the drain

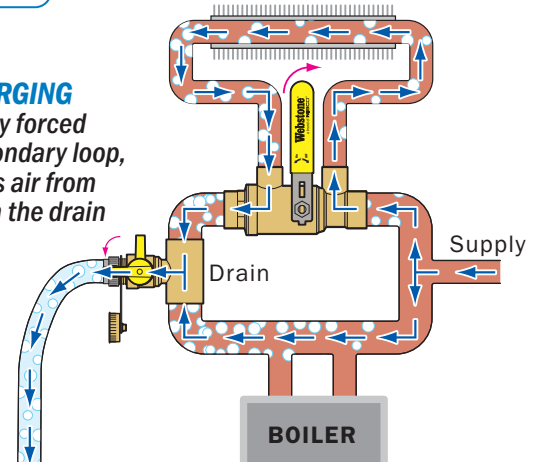

DIFFERENTIAL PRESSURE BY-PASS VALVE

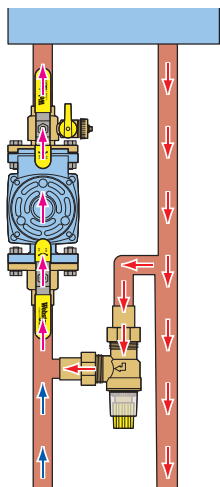

- Eliminates noise in a zoned hydronic system with fixed-speed primary circulator pump
- Protects system components
- Maintains system efficiency
- Prevents over-pumping of zones
- Installs between the boiler supply and return lines, or between zone legs in larger systems
- Installs in any orientation

Under partial loads, the DPBV opens to ensure quiet operation and appropriate pressures at the boiler circulator. With all zones active, the DPBV remains closed.



SEE PAGES 4-7

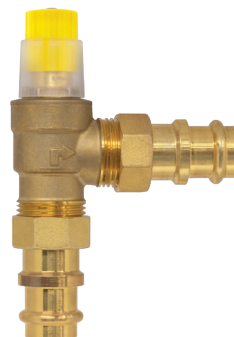

FORGED BRASS DIFFERENTIAL PRESSURE BY-PASS VALVE

Opening Differential Pressure Setting Adjustable from 1.5 to 9 PSI

SIZE	MAX GPM	ITEM#	STANDARD BRASS CTN/CASE	CASE WT
H-7x50 Series				
		145 PSI CWP Max/230°F Max		
FIP				
3/4"	9	H-74533	1/36	25
1"	18	H-74544	1/36	31
MIP				
3/4"	9	H-72533	1/36	25
1"	18	H-72544	1/36	31
SWT				
3/4"	9	H-75533	1/36	25
1"	18	H-75544	1/36	31
Press				
3/4"	9	H-78533	1/36	25
1"	18	H-78544	1/36	31
H-7x50B Series				
Body Only • Install w/ (2) G-Union Fittings				
		145 PSI CWP Max/230°F Max		
G-Thread				
1"	9	H-70530	1/36	22
1"	18	H-70540	1/36	27

FORGED BRASS ANGLED DIFFERENTIAL PRESSURE BY-PASS VALVE

Opening Differential Pressure Setting Adjustable from 1.5 to 9 PSI

SIZE	MAX GPM	ITEM#	STANDARD BRASS CTN/CASE	CASE WT
H-7x50-A Series				
		145 PSI CWP Max/230°F Max		
FIP				
3/4"	9	H-74533-A	1/36	22
1"	18	H-74544-A	1/36	27
MIP				
3/4"	9	H-72533-A	1/36	22
1"	18	H-72544-A	1/36	27
SWT				
3/4"	9	H-75533-A	1/36	22
1"	18	H-75544-A	1/36	27
Press				
3/4"	9	H-78533-A	1/36	22
1"	18	H-78544-A	1/36	27
H-7x50AB Series				
Body Only • Install w/ (2) G-Union Fittings				
		145 PSI CWP Max/230°F Max		
G-Thread				
1"	9	H-70530-A	1/36	22
1"	18	H-70540-A	1/36	27

HORIZONTAL AIR SEPARATOR

BRASS AIR SEPARATOR

w/ Removable Vent Head & Coalescing Medium

SIZE	ITEM#	STANDARD BRASS CTN/CASE	CASE WT
H-7x00 Series			
150 PSI CWP Max/250°F Max			
FIP			
3/4"	H-74003	1/10	26
1"	H-74004	1/10	30
1 1/4"	H-74005	1/10	28
1 1/2"	H-74006	1/4	26
2"	H-74007	1/4	27
SWT			
3/4"	H-75003	1/10	27
1"	H-75004	1/10	28
1 1/4"	H-75005	1/10	27
1 1/2"	H-75006	1/4	22
2"	H-75007	1/4	27
Press			
3/4"	H-78003	1/10	29
1"	H-78004	1/10	32
1 1/4"	H-78005	1/10	35
1 1/2"	H-78006	1/4	31
2"	H-78007	1/4	35

H-7G00 Series

Body Only • Install w/ (2) G-Union Fittings

SIZE	ITEM#	STANDARD BRASS CTN/CASE	CASE WT
G-Thread			
150 PSI CWP Max/200°F Max			
1"	H-7G004	1/10	28
1 1/2"	H-7G006	1/4	28
2"	H-7G007	1/4	29

- Reduces noise
- Improves system efficiency and operation
- Reduces wear on system components
- Flow may be directed into either side of the unit
- Vertical or horizontal mount options



SEE PAGES 4-7

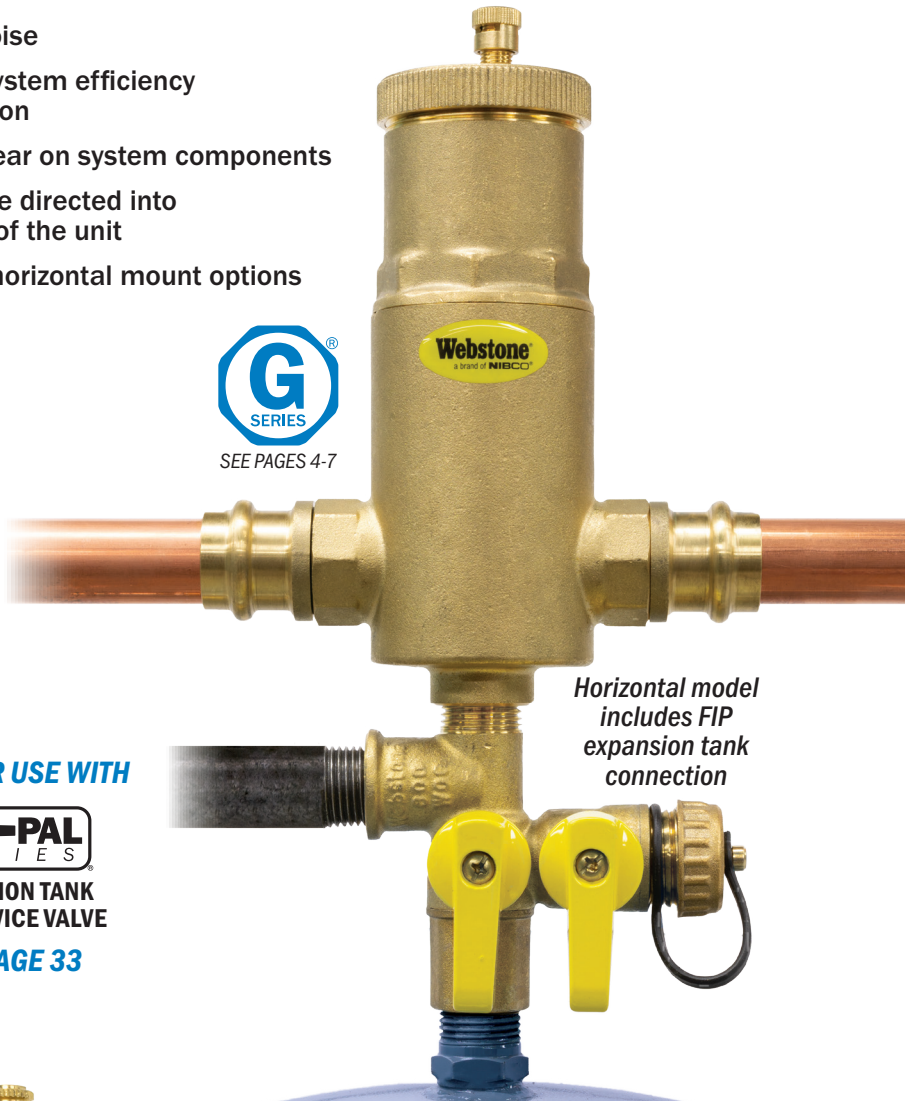

Horizontal model includes FIP expansion tank connection

IDEAL FOR USE WITH



EXPANSION TANK
PRO SERVICE VALVE

SEE PAGE 33

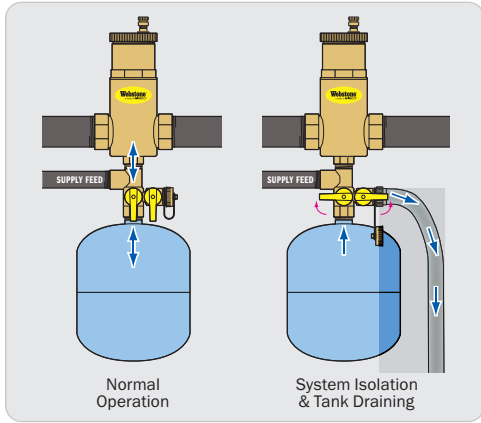

AUTOMATIC AIR VENT

- Automatically releases trapped air
- Removable vent head for service

FORGED BRASS AIR VENT

w/ Removable Vent Head

SIZE	ITEM#	STANDARD BRASS CTN/CASE	CASE WT
H-7x60 Series			
145 PSI CWP Max/230°F Max			
MIP			
1/8"	H-74600	1/50	17
1/4"	H-74601	1/50	18
1/2"	H-74602	1/50	19

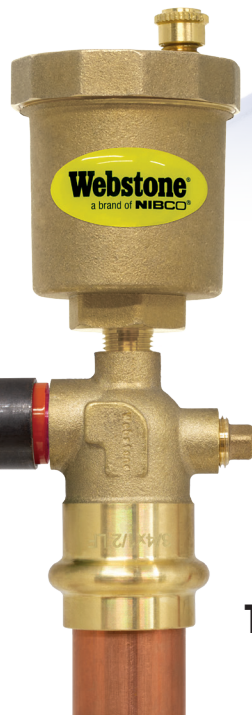

VENT INSTALLATION OPTIONS
FOR ANY INSTALLATION



T-VALVE

SEE PAGE 49



DUAL VENT
TRANSITION
ELBOW

SEE PAGE 55

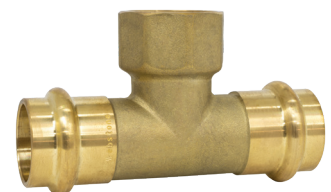

TRANSITION TEE

SEE PAGE 56

VERTICAL AIR SEPARATOR

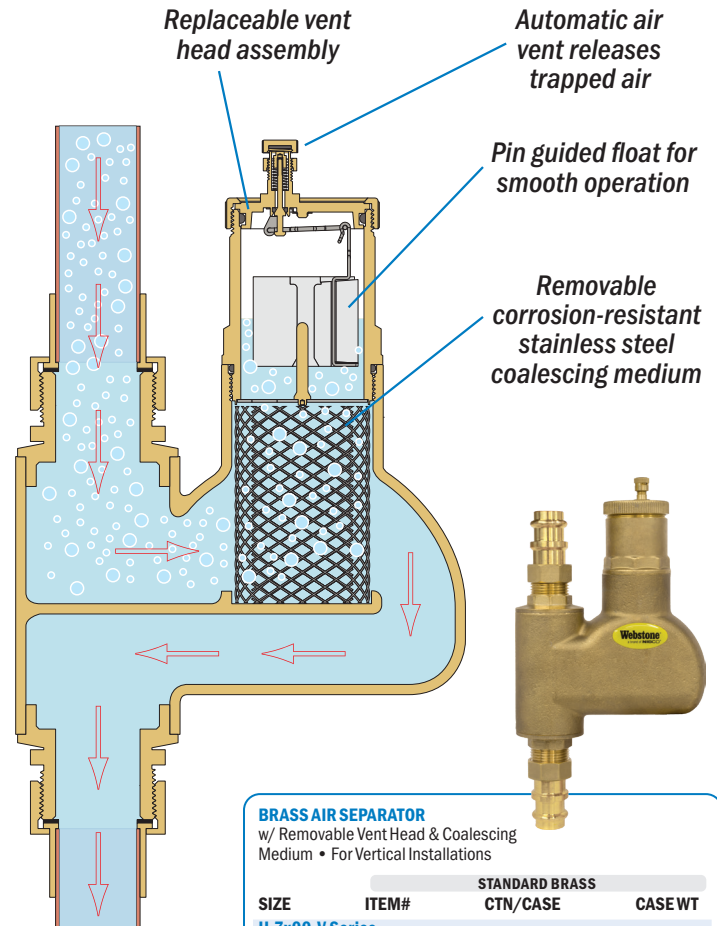

BRASS AIR SEPARATOR

w/ Removable Vent Head & Coalescing Medium • For Vertical Installations

SIZE	ITEM#	STANDARD BRASS	
		CTN/CASE	CASE WT
H-7x00-V Series			
FIP			
3/4"	H-74003-V	1/4	24
1"	H-74004-V	1/4	25
MIP			
3/4"	H-72003-V	1/4	23
1"	H-72004-V	1/4	24
SWT			
3/4"	H-75003-V	1/4	23
1"	H-75004-V	1/4	24
Press			
3/4"	H-78003-V	1/4	24
1"	H-78004-V	1/4	24
H-7100-V Series			
Body Only • Install w/ (2) G-Union Fittings			
G-Thread			
1"	H-71000-V	1/4	21

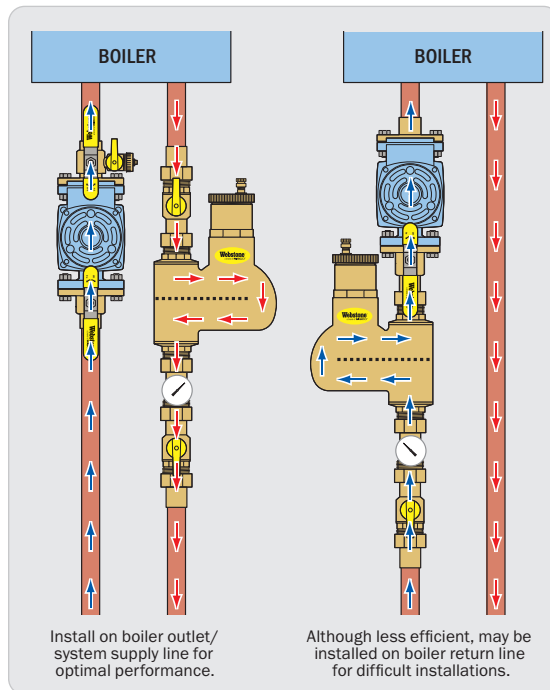

VENT HEAD ASSEMBLY



- Replacement vent assembly compatible with vertical and horizontal air separator, and hydraulic separator

REPLACEMENT VENT ASSEMBLY

H-7x00-RVA Series			
SIZE	ITEM#	CTN/CASE	CASE WT
FITS 3/4"-2" AIR SEPARATOR	H-74000	1/50	14



BOILER VENT VALVE

PATENTED TECHNOLOGY



- Expands the utility of 3/4" pressure relief valve (PRV) port at the top of unit for installation of air vent and other accessories
- Union connection to boiler for easier installation and flexible positioning
- Includes an automatic air vent to release trapped air from the appliance
- Integrated ball valve isolates vent for service without obstructing the PRV
- 3/4" FIP port accommodates PRV provided with your boiler (or sold separately - see page 21)
- 3/4" close nipple provided for convenient adaptations to your specific boiler equipment
- Plugged 3/4" FIP port for optional low water cutoff device
- Dual-sided plugged 1/4" FIP gauge ports

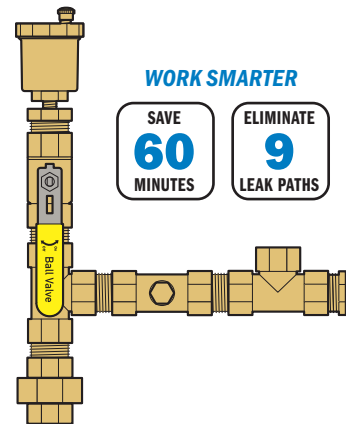

WORKS WITH LOW WATER CUTOFF DEVICE OF YOUR CHOICE

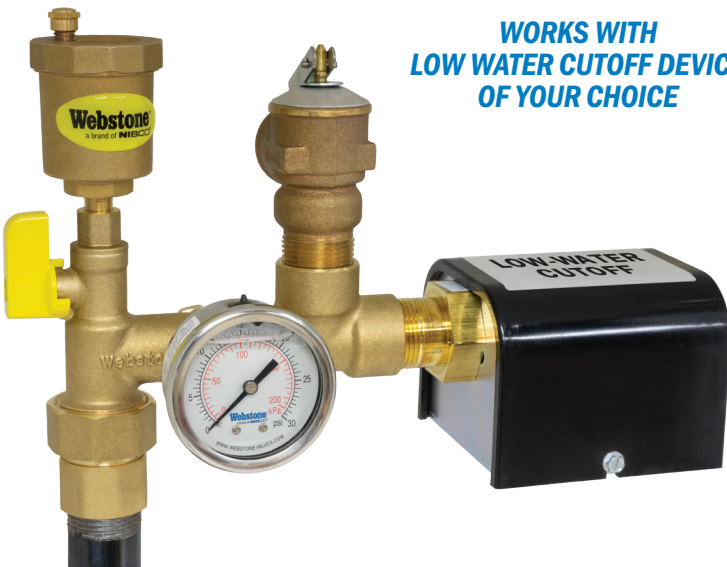

PRO-PAL BOILER VENT VALVE

Full Port Forged Brass Ball Valve w/ Auto Air Vent, 3/4 FIP Pressure Relief Valve Port, 1/4 NPT Gauge Ports (Plugged), 3/4 FIP Low Water Cutoff Port (Plugged), & 3/4 Close Nipple

SIZE	STANDARD BRASS		
	ITEM#	CTN/CASE	CASE WT
H-7x61 Series			
FIP		145 PSI CWP Max/200°F Max	
3/4"	H-74613	1/20	34



E-TANK SERVICE ASSEMBLY

PATENTED TECHNOLOGY

- All-in-one, space-saving solution simplifies hydronic expansion tank installation and service
- Provides isolation for the water supply and system
- Union connections for flexible handle positioning
- Dedicated drain valve for servicing the tank
- Union expansion tank connection allows the tank to be supported during removal
- Supports tanks up to 8 gallons

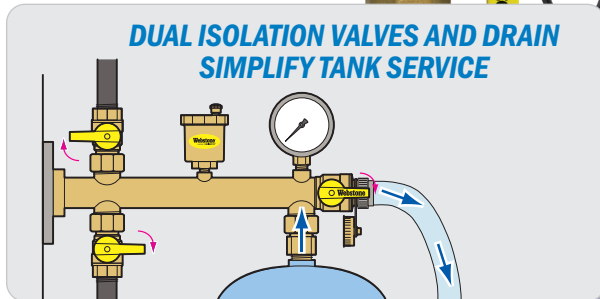
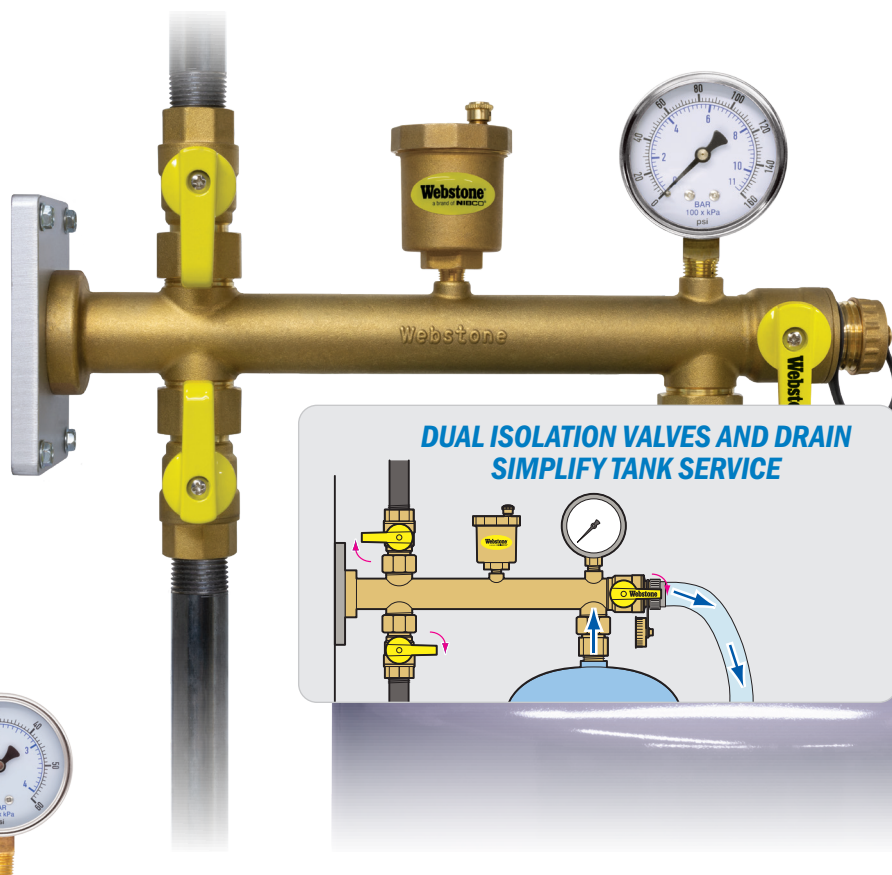

PRO-PAL E-TANK SERVICE ASSEMBLY

Forged Brass Mounting Arm w/ Full Port Isolation Valves, Expansion Tank Port & Hi-Flow Hose Drain • Includes Automatic Air Vent & Pressure Gauge • For Hydronic Applications

SIZE	ITEM#	STANDARD BRASS CTN/CASE	CASE WT
H-x367 Series			
FIP		200 PSI CWP Max/200°F Max	
1/2"	H-43672	1/6	31

STEEL PLATED DRY PRESSURE GAUGE

Dual Scale, 2" Dial w/ Bottom Connection

SIZE	ITEM#	CTN/CASE	CASE WT
H-3100-BTM Series			
MIP		60 PSI CWP Max	
1/4"	H-31000-60BTM	1/150	30



EXPANSION TANK PRO SERVICE VALVE™

- The 3-way ball controls flow between the expansion tank and the system
- Quickly connect entire system to the cold water feed
- MIP model for direct connection to air separator or tee
- FIP model allows for distance between tank and system

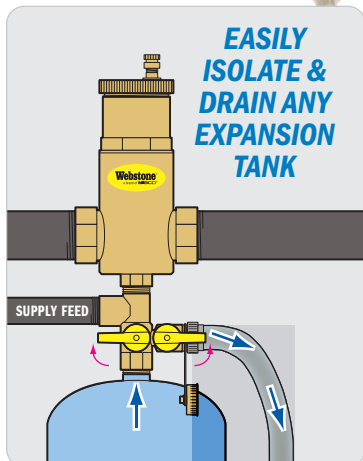

IDEAL FOR USE WITH HORIZONTAL AIR SEPARATOR
SEE PAGE 30

PRO-PAL EXPANSION TANK PRO SERVICE VALVE

Full Port Forged Brass Ball Valve w/ Hi-Flow Hose Drain

SIZE	ITEM#	STANDARD BRASS CTN/CASE	CASE WT
H-x167 Series			
MIP/SWT × FIP × FIP × Hose		600 PSI CWP Max/250°F Max	
1/2"	H-41672	1/30	30
FIP × Hose		600 PSI CWP Max	
1/2"	H-44672	1/30	31

WORK SMARTER

SAVE
50
MINUTES

ELIMINATE
6
LEAK PATHS

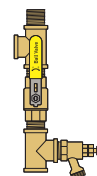

MAGNETIC BOILER FILTER XL

THE **POWERFUL** WAY TO STAY **EFFICIENT**



SEE PAGES 4-7



Includes Service Tool

PATENTED TECHNOLOGY

- High-powered 12,000 Gauss magnet captures ferrous debris
- Mess-free clean out - remove magnet from sleeve and debris falls into cavity below
- G-Union connections simplify installation
- Ideal for larger boilers
- Installed on system run
- Includes service tool
- Protects system components
- Maintains system efficiency

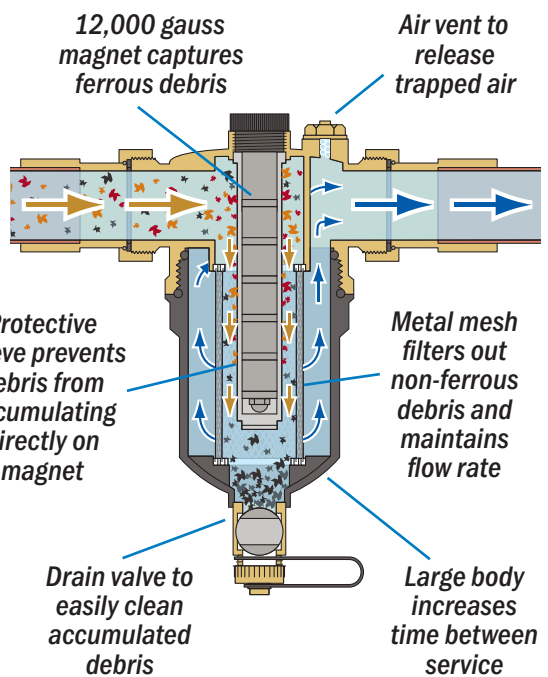

MAGNETIC BOILER FILTER XL
12,000 Gauss Magnet, Integrated Hose Drain Valve, Air Vent & Filter • Includes (2) Union End Connections & Service Tool

SIZE	ITEM#	STANDARD BRASS	
		CTN/CASE	CASE WT
H-7x70XL Series			
145 PSI CWP Max/250°F Max			
FIP			
1 1/4"	H-74705	1/4	23
1 1/2"	H-74706	1/4	24
MIP			
1 1/4"	H-72705	1/4	24
1 1/2"	H-72706	1/4	24
SWT			
1 1/4"	H-75705	1/4	21
1 1/2"	H-75706	1/4	23
Press			
1 1/4"	H-78705	1/4	24
1 1/2"	H-78706	1/4	26
H-7x70XLB Series			
Body Only • Install w/ (2) G-Union Fittings			
145 PSI CWP Max/250°F Max			
G-Thread			
1 1/2"	H-70706	1/4	20

MAGNETIC BOILER FILTER

- High-powered 12,000 Gauss magnet captures ferrous debris
- Mess-free clean out - remove magnet from sleeve and debris falls into cavity below
- Universal diverter allows use with any piping orientation
- G-Union connections with or without available isolation valves
- Includes service tool
- Protects system components
- Maintains system efficiency



Includes Service Tool



SEE PAGES 4-7



MAGNETIC BOILER FILTER

12,000 Gauss Magnet, Diverter, Integrated Hose Drain Valve, Air Vent & Filter Includes (2) Union End Connections & Service Tool

STANDARD BRASS			
SIZE	ITEM#	CTN/CASE	CASE WT
H-7x70 Series			
FIP		175 PSI CWP Max/250°F Max	
3/4"	H-74703	1/4	11
1"	H-74704	1/4	11
MIP			
3/4"	H-72703	1/4	11
1"	H-72704	1/4	11
SWT			
3/4"	H-75703	1/4	11
1"	H-75704	1/4	11
Press			
3/4"	H-78703	1/4	11
1"	H-78704	1/4	11
H-7x71 Series			
FIP		175 PSI CWP Max/250°F Max	
3/4"	H-74713	1/4	11
1"	H-74714	1/4	11
MIP			
3/4"	H-72713	1/4	11
1"	H-72714	1/4	11
SWT			
3/4"	H-75713	1/4	11
1"	H-75714	1/4	11
Press			
3/4"	H-78713	1/4	11
1"	H-78714	1/4	11
H-7x70B Series			
Body Only • Install w/ (2) G-Union Fittings			
G-Thread		175 PSI CWP Max/250°F Max	
1"	H-70700	1/4	12

Install on boiler inlet/system return line for maximum boiler protection

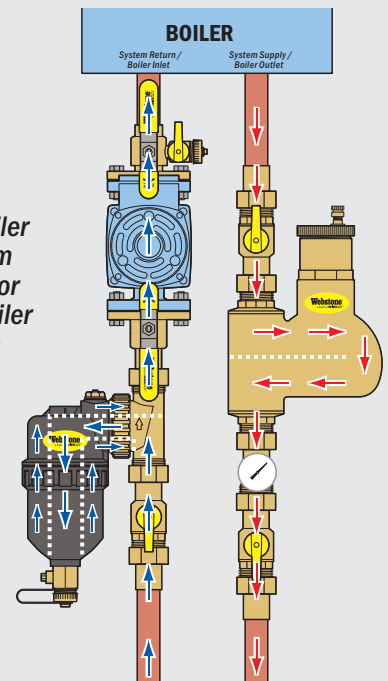

WHERE WOULD YOU USE WEBSTONE? SAVE TIME, SAVE SPACE & SAVE LABOR

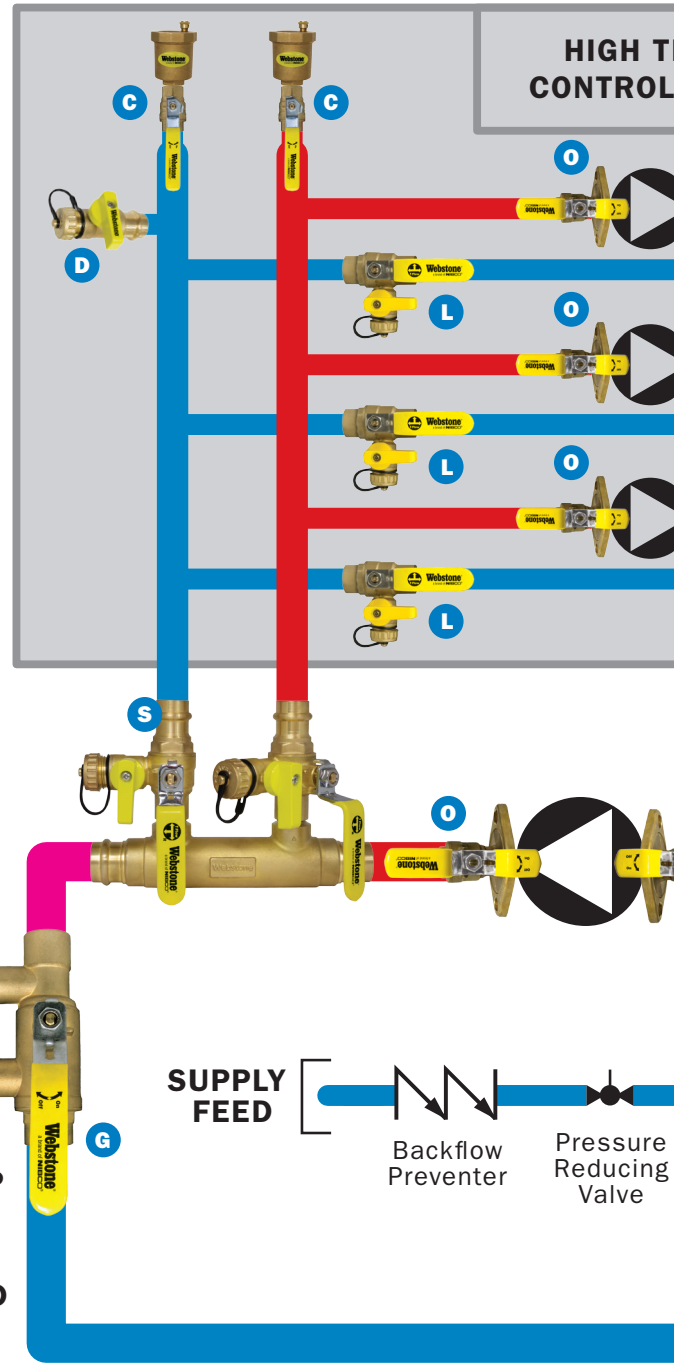
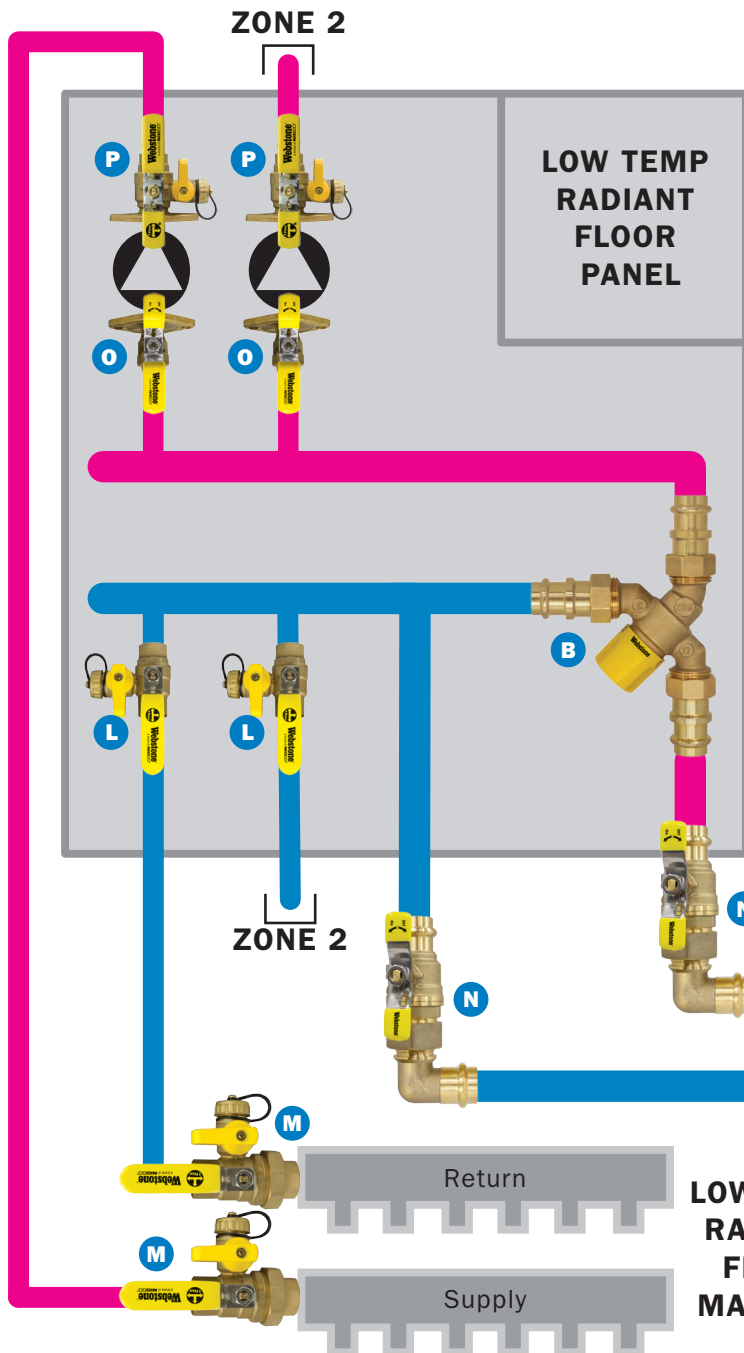

PURGE TEE
PAGE 29



PURGE & FILL
PAGE 50



T-DRAIN
PAGE 50



**EXPANSION
TANK PRO
SERVICE VALVE**
PAGE 33



**BALL DRAIN
STRAINER**
PAGE 39



BALL DRAIN
PAGE 44



**UNION
BALL DRAIN**
PAGE 45



L-UNION BALL
PAGE 47

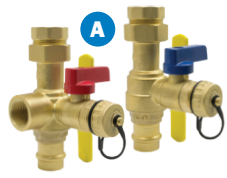

TWH SERVICE VALVES
E.X.P.
SERIES

PAGE 20

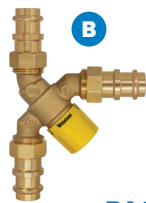

THERMOSTATIC MIXING VALVE
PAGE 8



BRASS BALL VALVE
PAGE 62



ADD-A-DRAIN
PAGE 51



GAS SEDIMENT TRAP
PAGE 23



BOILER VENT VALVE
PAGE 32

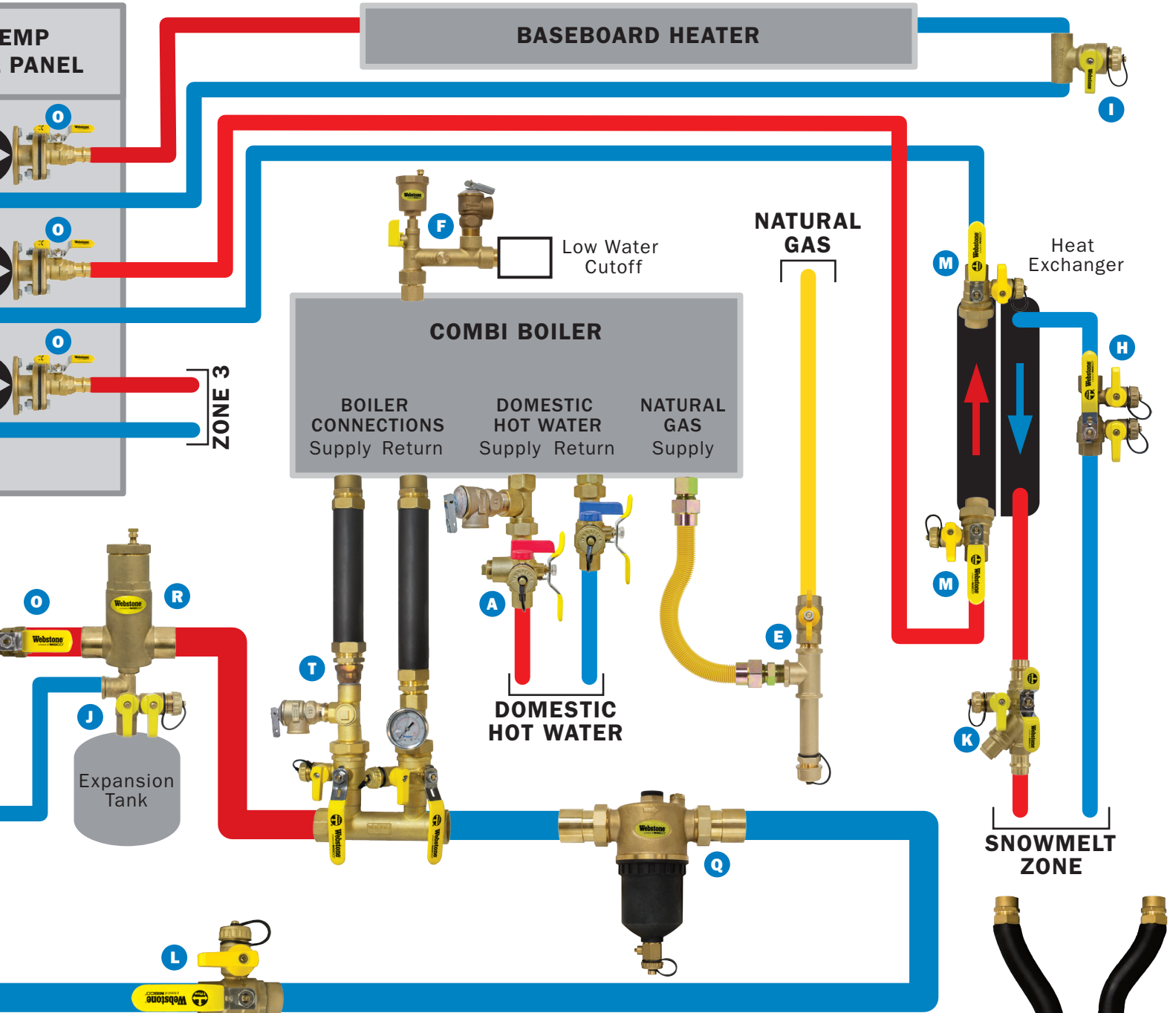

The **ISOLATOR**
UNI-FLANGE BALL VALVE
W/ ROTATING FLANGE

PAGE 40



The **ISOLATOR**
UNI-FLANGE BALL VALVE
W/ ROTATING FLANGE &
MULTI-FUNCTION DRAIN

PAGE 40



MAGNETIC
BOILER FILTER XL

PAGE 34



AIR
SEPARATOR

PAGE 30



HYDRO-CORE
MANIFOLD

PAGE 25



HYDRO-CORE
COMPLETE NEAR BOILER PIPING KIT

PAGE 26

Y-STRAINERS

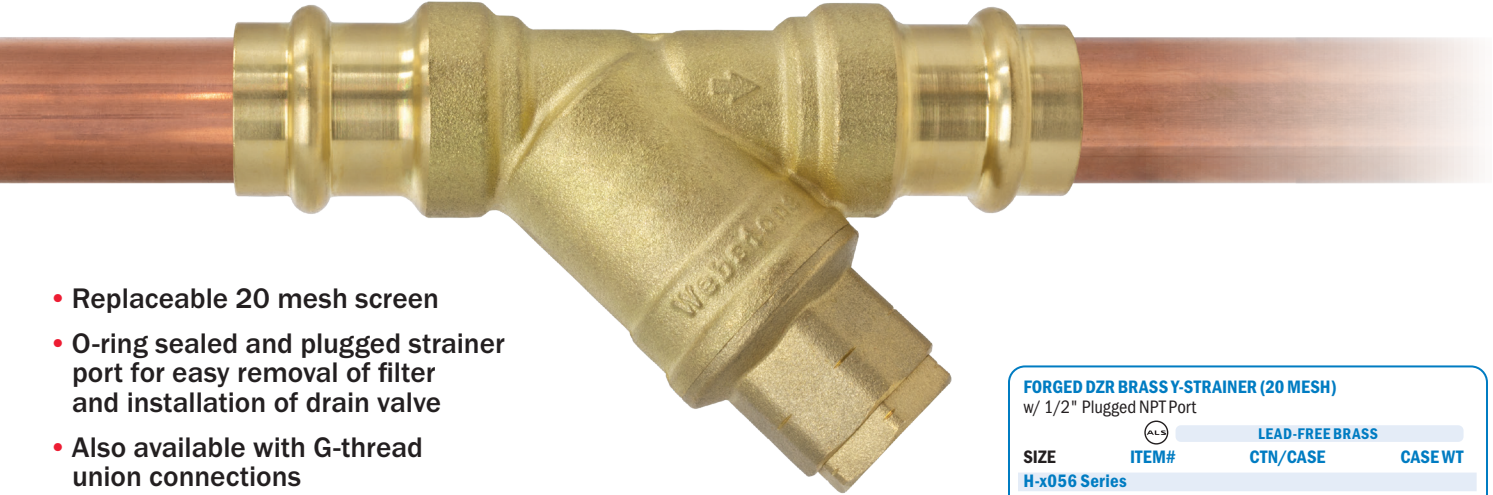

- Replaceable 20 mesh screen
- O-ring sealed and plugged strainer port for easy removal of filter and installation of drain valve
- Also available with G-thread union connections

**SUITABLE FOR
VERTICAL OR
HORIZONTAL
INSTALLATION**



SEE PAGES 4-7



FORGED DZR BRASS Y-STRAINER (20 MESH)

w/ 1/2" Plugged NPT Port

SIZE	ITEM#	CTN/CASE	CASE WT
LEAD-FREE BRASS			
H-x056 Series			
		250 PSI CWP Max/200°F Max	
FIP			
1/2"	H-40562W	8/80	43
3/4"	H-40563W	6/60	44
1"	H-40564W	4/40	37
1 1/4"	H-40565W	4/24	37
1 1/2"	H-40566W	2/20	45
2"	H-40567W	2/10	34
SWT			
1/2"	H-50562W	8/80	31
3/4"	H-50563W	6/60	37
1"	H-50564W	4/40	32
1 1/4"	H-50565W	4/24	31
1 1/2"	H-50566W	2/20	38
2"	H-50567W	2/8	27
Press			
1/2"	H-80562W	12/72	43
3/4"	H-80563W	6/48	41
1"	H-80564W	5/40	40
1 1/4"	H-80565W	4/24	38
1 1/2"	H-80566W	2/12	28
2"	H-80567W	2/8	29
H-G056 Series			
Body Only • Install w/ (2) G-Union Fittings			
G-Thread		200 PSI CWP Max/200°F Max	
1"	H-G0564W	1/18	20
1 1/2"	H-G0566W	1/8	20

- Connect a Y-strainer directly to any standard circulator pump
- Rotating flange provides versatility
- 1/2" plugged NPT strainer port for installation of drain valve



Y-STRAINER W/ ROTATING FLANGE

SIZE	ITEM#	CTN/CASE	CASE WT
STANDARD BRASS			
H-HCE-PUMP Series			
SWT • Rotating Flange		600 PSI CWP Max/	
1"	H-FSTR4-54	6/24	39

MESH INSERTS

- Compatible with H-x056 Y-strainer and H-x156 Ball Drain Strainer
- 20 mesh factory replacement option
- 40 mesh captures finer particles



Y-STRAINER MESH INSERTS

STRAINER SIZE	ITEM#	CTN/CASE	CASE WT
H-GX56-RS Series			
Stainless Steel - 20 Mesh			
1/2"	H-LV02490-02	1/120	1
3/4" & 1"	H-LV02489-02	1/120	2
1 1/4"	H-LV02492-02	1/40	1
1 1/2"	H-LV02493-02	1/40	1
2"	H-LV02494-02	1/24	1
H-GX56-RS Series			
Stainless Steel - 40 Mesh			
1/2"	H-GX562W-40M	1/120	1
3/4" & 1"	H-GX563W-40M	1/120	2
1 1/4"	H-GX565W-40M	1/40	1
1 1/2"	H-GX566W-40M	1/40	1
2"	H-GX567W-40M	1/24	1



BALL DRAIN STRAINER™

PATENTED TECHNOLOGY

- Eliminates assemblies needed to isolate and drain any portion of a piped system
- Integrated Y-strainer saves space and protects system from debris
- Creates cleaner-looking, more efficient installations
- Suitable for vertical or horizontal installation
- Replaceable mesh screen
- O-ring sealed and plugged strainer port for easy removal of filter and installation of drain valve

BALL DRAIN STRAINER

Full Port Forged DZR Brass Ball Valve w/ Hi-Flow Multi-Function Hose Drain, Integral Y-Strainer (20 Mesh), 1/2" Plugged NPT Port & Adjustable Packing Glands

SIZE	ITEM#	CTN/CASE	CASE WT
LEAD-FREE BRASS			
H-x156 Series			
FIP		250 PSI CWP Max/200°F Max	
1/2"	H-41562W	4/32	41
3/4"	H-41563W	2/24	40
1"	H-41564W	2/20	44
1 1/4"	H-41565W	2/12	43
Press		250 PSI CWP Max/200°F Max	
1/2"	H-81562W	2/24	32
3/4"	H-81563W	2/20	36
1"	H-81564W	2/12	28
1 1/4"	H-81565W	2/8	30
H-G156 Series			
Body Only • Install w/ (2) G-Union Fittings			
G-Thread			
		200 PSI CWP Max/200°F Max	
1"	H-G1564W	1/12	29
1 1/2"	H-G1566W	1/4	21



SEE PAGES 4-7



WORK SMARTER

SAVE 60 MINUTES

ELIMINATE 7 LEAK PATHS

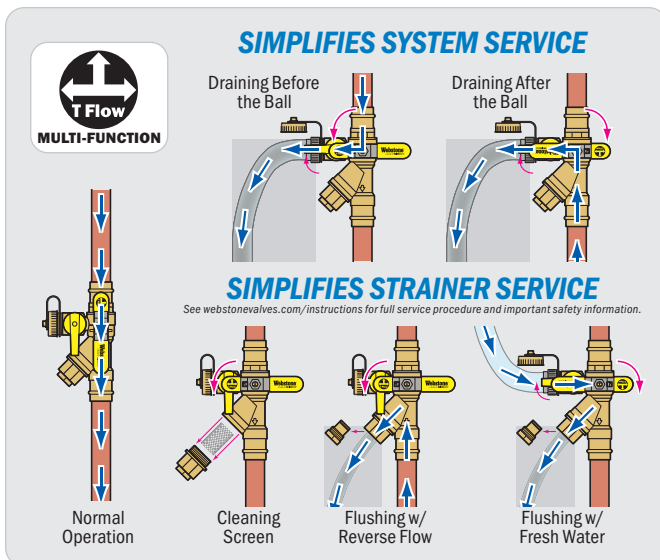

ISOLATOR® PUMP FLANGE VALVES



THE ONLY WAY TO ISOLATE CIRCULATOR PUMPS

PATENTED TECHNOLOGY

These valves have revolutionized the installation of circulator pumps. Our original Isolator Uni-Flange Ball Valve design has evolved into the largest flanged ball valve program in the industry today.

- Conical inlet to minimize turbulence
- Fits virtually any standard circulator pump
- Choice of rotating or fixed flange
- Available multi-function drain purges from both sides of the pump
- Available slotted holes for high velocity pumps
- Prevents electrolysis
- Eliminates galvanic corrosion
- Also available for high efficiency variable speed pumps - see page 42

WORK SMARTER

SAVE
60
MINUTES

ELIMINATE
7
LEAK PATHS

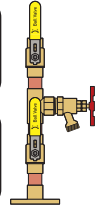

WORK SMARTER

SAVE
15
MINUTES

ELIMINATE
2
LEAK PATHS

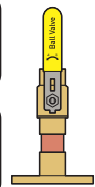

ISOLATOR W/ ROTATING FLANGE

Full Port Forged Brass Uni-Flange Ball Valve w/ Detachable Rotating Flange, Adjustable Packing Gland, Nuts & Bolts

SIZE	STANDARD BRASS				LEAD-FREE BRASS			
	ITEM#	HV ITEM#	CTN/CASE	CASE WT	ITEM#	HV ITEM#	CTN/CASE	CASE WT
H-x140 Series								
FIP × Rotating Flange						600 PSI CWP Max/250°F Max		
3/4"	H-41403	H-41403HV	1/20	33	H-41403W	H-41403WHV	2/20	27
1"	H-41404	H-41404HV	1/20	40	H-41404W	H-41404WHV	2/20	35
1 1/4"	H-41405	H-41405HV	1/20	48	H-41405W	H-41405WHV	2/20	45
1 1/2"	H-41406	H-41406HV	1/20	65	H-41406W	H-41406WHV	2/10	32
2"	-	-	-	-	-	H-41407WHV	1/10	36
SWT × Rotating Flange						600 PSI CWP Max/250°F Max		
3/4"	H-51403	H-51403HV	1/20	33	H-51403W	H-51403WHV	2/20	27
1"	H-51404	H-51404HV	1/20	40	H-51404W	H-51404WHV	2/20	35
1 1/4"	H-51405	H-51405HV	1/20	48	H-51405W	H-51405WHV	2/20	45
1 1/2"	H-51406	H-51406HV	1/20	66	H-51406W	H-51406WHV	2/10	33
2"	-	-	-	-	-	H-51407WHV	1/10	34
Press × Rotating Flange						250 PSI CWP Max/250°F Max		
3/4"	H-81403	H-81403HV	1/20	28	H-81403W	H-81403WHV	1/20	28
1"	H-81404	H-81404HV	1/20	35	H-81404W	H-81404WHV	1/20	40
1 1/4"	H-81405	H-81405HV	1/20	45	H-81405W	H-81405WHV	1/20	53
1 1/2"	H-81406	H-81406HV	1/10	31	H-81406W	H-81406WHV	1/10	32
2"	-	H-81407HV	1/10	36	-	H-81407WHV	1/10	51
F1960 PEX × Rotating Flange						400 PSI CWP Max		
3/4"	-	-	-	-	H-31403W	H-31403WHV	1/20	27
1"	-	-	-	-	H-31404W	H-31404WHV	1/20	27
F1807 PEX × Rotating Flange						400 PSI CWP Max		
3/4"	-	-	-	-	H-11403W	H-11403WHV	1/20	27
1"	-	-	-	-	H-11404W	H-11404WHV	1/20	29

HV ITEMS FIT HIGH VELOCITY & STANDARD SIZE PUMPS • 2" ISOLATORS HAVE 1 1/2" PORT

PEX ALSO CERTIFIED TO

ISOLATOR W/ ROTATING FLANGE & MULTI-FUNCTION DRAIN

Full Port Forged Brass Uni-Flange Ball Valve w/ Detachable Rotating Flange, Multi-Function Hi-Flow Hose Drain, Adjustable Packing Glands, Nuts & Bolts

SIZE	STANDARD BRASS				LEAD-FREE BRASS			
	ITEM#	HV ITEM#	CTN/CASE	CASE WT	ITEM#	HV ITEM#	CTN/CASE	CASE WT
H-x141 Series								
FIP × Rotating Flange						600 PSI CWP Max/250°F Max		
3/4"	H-41413	H-41413HV	1/20	41	H-41413W	H-41413WHV	2/20	35
1"	H-41414	H-41414HV	1/20	48	H-41414W	H-41414WHV	2/20	41
1 1/4"	H-41415	H-41415HV	1/20	61	H-41415W	H-41415WHV	2/10	27
1 1/2"	H-41416	H-41416HV	1/10	40	H-41416W	H-41416WHV	2/10	36
2"	-	-	-	-	-	H-41417WHV	1/10	38
SWT × Rotating Flange						600 PSI CWP Max/250°F Max		
3/4"	H-51413	H-51413HV	1/20	41	H-51413W	H-51413WHV	2/20	36
1"	H-51414	H-51414HV	1/20	48	H-51414W	H-51414WHV	2/20	41
1 1/4"	H-51415	H-51415HV	1/20	62	H-51415W	H-51415WHV	2/10	28
1 1/2"	H-51416	H-51416HV	1/10	41	H-51416W	H-51416WHV	2/10	33
2"	-	-	-	-	-	H-51417WHV	1/10	36
Press × Rotating Flange						250 PSI CWP Max/250°F Max		
3/4"	H-81413	H-81413HV	1/20	37	H-81413W	H-81413WHV	1/20	43
1"	H-81414	H-81414HV	1/20	43	H-81414W	H-81414WHV	1/20	50
1 1/4"	H-81415	H-81415HV	1/10	30	H-81415W	H-81415WHV	1/10	34
1 1/2"	H-81416	H-81416HV	1/10	38	H-81416W	H-81416WHV	1/10	41
2"	-	H-81417HV	1/10	42	-	H-81417WHV	1/10	42
F1960 PEX × Rotating Flange						400 PSI CWP Max		
3/4"	-	-	-	-	H-31413W	H-31413WHV	1/20	39
1"	-	-	-	-	H-31414W	H-31414WHV	1/20	45
F1807 PEX × Rotating Flange						400 PSI CWP Max		
3/4"	-	-	-	-	H-11413W	H-11413WHV	1/20	39
1"	-	-	-	-	H-11414W	H-11414WHV	1/20	39

HV ITEMS FIT HIGH VELOCITY & STANDARD SIZE PUMPS • 2" ISOLATORS HAVE 1 1/2" PORT

PEX ALSO CERTIFIED TO



AVAILABLE MULTI-FUNCTION DRAIN PURGES BEFORE OR AFTER PUMP

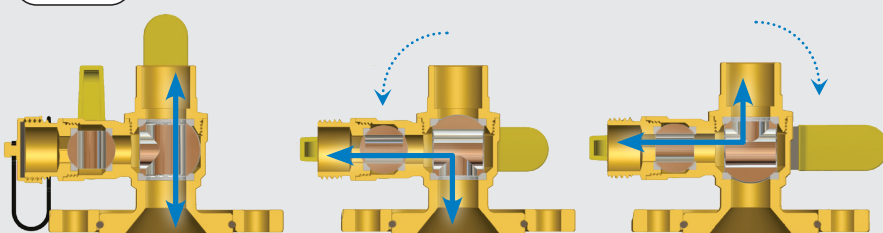

FITS STANDARD OR HIGH-VELOCITY PUMPS

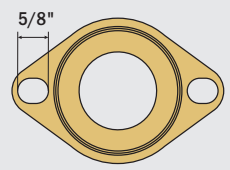
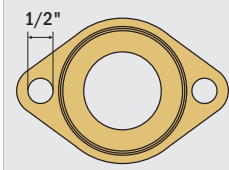

ITEM#
1/2" HOLE FITS
STANDARD SIZE PUMPS

HV ITEM#
5/8" SLOTTED HOLE FITS
HIGH VELOCITY & STANDARD
SIZE PUMPS

ISOLATOR UNI-FLANGE BALL VALVE

Full Port Forged Brass Ball Valve w/ Adjustable Packing Gland, Nuts & Bolts

STANDARD BRASS				
SIZE	ITEM#	HV ITEM#	CTN/CASE	CASE WT
H-x040 Series				
FIP × Flange 600 PSI CWP Max				
1/2"	H-40402	-	1/20	30
3/4"	H-40403	H-40403HV	1/20	34
1"	H-40404	H-40404HV	1/20	41
1 1/4"	H-40405	H-40405HV	1/20	47
1 1/2"	H-40406	H-40406HV	1/20	66
2"	-	H-40407HV	1/10	43
SWT × Flange 600 PSI CWP Max				
1/2"	H-50402	-	1/20	29
3/4"	H-50403	H-50403HV	1/20	34
1"	H-50404	H-50404HV	1/20	41
1 1/4"	H-50405	H-50405HV	1/20	48
1 1/2"	H-50406	H-50406HV	1/20	67
2"	-	H-50407HV	1/10	45

HV ITEMS FIT HIGH VELOCITY & STANDARD SIZE PUMPS
2" ISOLATORS HAVE 1 1/2" PORT



ISOLATOR W/ DRAIN

Full Port Forged Brass Uni-Flange Ball Valve w/ Hi-Flow Hose Drain, Adjustable Packing Glands, Nuts & Bolts

STANDARD BRASS				
SIZE	ITEM#	HV ITEM#	CTN/CASE	CASE WT
H-x041 Series				
FIP × Flange 600 PSI CWP Max				
3/4"	H-40413	H-40413HV	1/20	48
1"	H-40414	H-40414HV	1/20	57
1 1/4"	H-40415	H-40415HV	1/20	70
1 1/2"	H-40416	H-40416HV	1/10	47
2"	-	H-40417HV	1/10	61
SWT × Flange 600 PSI CWP Max				
3/4"	H-50413	H-50413HV	1/20	48
1"	H-50414	H-50414HV	1/20	57
1 1/4"	H-50415	H-50415HV	1/20	71
1 1/2"	H-50416	H-50416HV	1/10	48
2"	-	H-50417HV	1/10	63

HV ITEMS FIT HIGH VELOCITY & STANDARD SIZE PUMPS
2" ISOLATORS HAVE 1 1/2" PORT



The ISOLATOR® UNI-FLANGE BALL VALVE® CIRCULATOR PUMP INSTALLATION KIT

Everything but the pump! Kits include your choice of Isolator & Isolator w/ Drain, two full-faced flange gaskets, and two sets of nuts & bolts.



ISOLATOR PUMP INSTALLATION KIT

Your choice of Isolator & Isolator w/ Drain & 2 Flange Gaskets, Nuts & Bolts

STANDARD BRASS				
SIZE	ITEM#	HV ITEM#	CTN/CASE	CASE WT
H-x041KIT Series				
FIP × Flange 600 PSI CWP Max				
3/4"	H-40413KIT	H-40413HVKIT	1/10	42
1"	H-40414KIT	H-40414HVKIT	1/10	50
1 1/4"	H-40415KIT	H-40415HVKIT	1/10	59
SWT × Flange 600 PSI CWP Max				
3/4"	H-50413KIT	H-50413HVKIT	1/10	42
1"	H-50414KIT	H-50414HVKIT	1/10	50
1 1/4"	H-50415KIT	H-50415HVKIT	1/10	60

HV ITEMS FIT HIGH VELOCITY & STANDARD SIZE PUMPS
2" ISOLATORS HAVE 1 1/2" PORT

ISOLATOR W/ ROTATING FLANGE PUMP INSTALLATION KIT

Your choice of Isolator w/ Rotating Flange & Isolator w/ Rotating Flange & Drain & 2 Flange Gaskets, Nuts & Bolts

STANDARD BRASS					LEAD-FREE BRASS			
SIZE	ITEM#	HV ITEM#	CTN/CASE	CASE WT	ITEM#	HV ITEM#	CTN/CASE	CASE WT
H-x141KIT Series								
FIP × Rotating Flange 600 PSI CWP Max/250°F Max								
3/4"	H-41413KIT	H-41413HVKIT	1/10	38	H-41413WKIT	H-41413WHVKIT	1/10	32
1"	H-41414KIT	H-41414HVKIT	1/10	50	H-41414WKIT	H-41414WHVKIT	1/10	38
1 1/4"	H-41415KIT	H-41415HVKIT	1/10	55	H-41415WKIT	H-41415WHVKIT	1/10	52
SWT × Rotating Flange 600 PSI CWP Max/250°F Max								
3/4"	H-51413KIT	H-51413HVKIT	1/10	38	H-51413WKIT	H-51413WHVKIT	1/10	32
1"	H-51414KIT	H-51414HVKIT	1/10	45	H-51414WKIT	H-51414WHVKIT	1/10	48
1 1/4"	H-51415KIT	H-51415HVKIT	1/10	56	H-51415WKIT	H-51415WHVKIT	1/10	61
1 1/2"	-	-	-	-	-	H-51416WHVKIT	1/10	67
2"	-	-	-	-	-	H-51417WHVKIT	1/10	69
Press × Rotating Flange 250 PSI CWP Max/250°F Max								
3/4"	-	H-81413HVKIT	1/10	32	-	-	-	-
1"	-	H-81414HVKIT	1/10	39	-	-	-	-
1 1/4"	-	H-81415HVKIT	1/10	52	-	-	-	-

HV ITEMS FIT HIGH VELOCITY & STANDARD SIZE PUMPS. 2" ISOLATORS HAVE 1 1/2" PORT

ISOLATOR® PUMP FLANGE VALVES

DESIGNED FOR HIGH EFFICIENCY VARIABLE SPEED PUMPS

The ISOLATOR® UNI-FLANGE BALL VALVE® with ROUND FLANGE

- Detachable rotating round flange
- Three flange styles compatible with a full range of popular pumps



ISOLATOR W/ ROUND FLANGE

Full Port Forged Brass Uni-Flange Ball Valve w/ Detachable Rotating Flange, Adjustable Packing Gland, Nuts & Bolts

SIZE	ITEM#	CTN/CASE	CASE WT
H-x140-RF Series			
FIP × Rotating Flange			
1 1/2"	H-41406HV-RF375	1/6	22
SWT × Rotating Flange			
1 1/2"	H-51406HV-RF375	1/6	22
H-x141-RF Series			
w/ Multi-Function Hi-Flow Hose Drain			
FIP × Rotating Flange			
1 1/2"	H-41416HV-RF375	1/6	26
SWT × Rotating Flange			
1 1/2"	H-51416HV-RF375	1/6	26
Press × Rotating Flange			
1 1/2"	H-81416HV-RF375	1/6	27

ISOLATOR W/ ROUND FLANGE

Full Port Forged Brass Uni-Flange Ball Valve w/ Detachable Rotating Flange, Adjustable Packing Gland, Nuts & Bolts

STANDARD BRASS			
SIZE	ITEM#	CTN/CASE	CASE WT
H-x140-RF Series			
FIP × Rotating Flange			
2"	H-41407HV-RF400	1/6	34
SWT × Rotating Flange			
2"	H-51407HV-RF400	1/6	36
Press × Rotating Flange			
2"	H-81407HV-RF400	1/6	36

ISOLATOR W/ ROUND FLANGE

Full Port Forged Brass Uni-Flange Ball Valve w/ Detachable Rotating Flange, Adjustable Packing Gland, Nuts & Bolts

STANDARD BRASS			
SIZE	ITEM#	CTN/CASE	CASE WT
H-x140-RF Series			
SWT × Rotating Flange			
2"	H-51407HV-RF475	1/6	33
H-x141-RF Series			
w/ Multi-Function Hi-Flow Hose Drain			
FIP × Rotating Flange			
2"	H-41417HV-RF475	1/6	38

FLANGE DIMENSIONS

	A	B	C	D	E
RF375	5"	3 7/8"	2 11/16"	5/8"	5/8"
RF400	5 1/4"	4"	-	9/16"	-
RF475	6 1/8"	4 3/4"	4"	-	13/16"

RF375 FLANGE

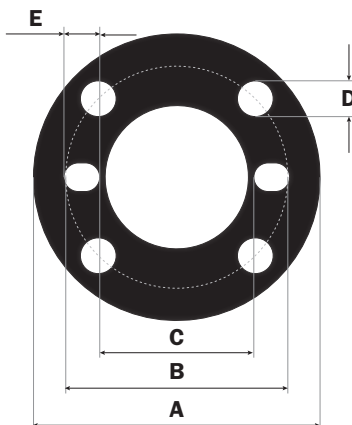

RF400 FLANGE

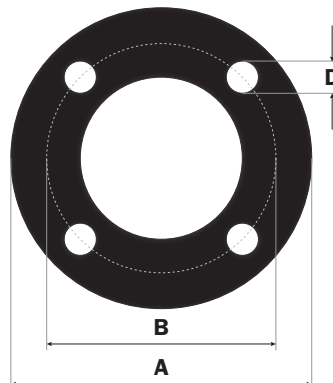

RF475 FLANGE

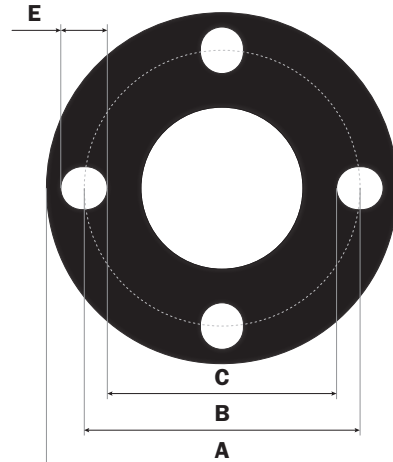

The ISOLATOR® UNI-FLANGE BALL VALVE® **SELECT™** WITH 4-WAY SELECTABLE FLOW PATH

- Easily fill, purge, sample or add a pressure gauge right at the pump
- 1" side ports enable quicker filling and purging – ideal for Geothermal applications
- Easily direct fluid between 4 available ports
- Easily isolate the pump for replacement

2-PUMP GEOTHERMAL SYSTEM OVERVIEW

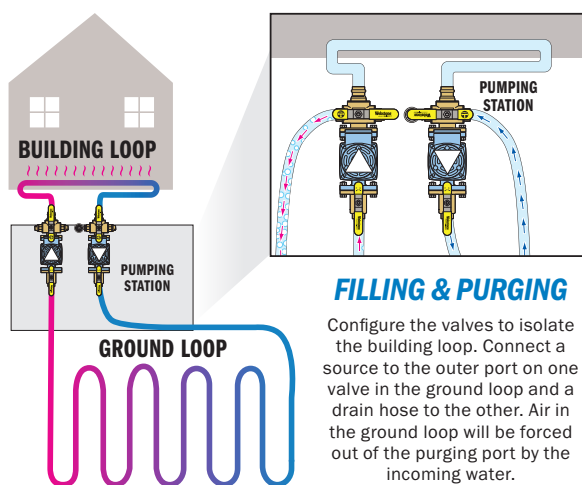

FILLING & PURGING

Configure the valves to isolate the building loop. Connect a source to the outer port on one valve in the ground loop and a drain hose to the other. Air in the ground loop will be forced out of the purging port by the incoming water.

**IDEAL FOR
GEOTHERMAL
APPLICATIONS**



ISOLATOR SELECT

Full Port Forged Brass Uni-Flange Ball Valve w/ 4-Way Selectable Flow Path, Plugged FNPT Ports, Adjustable Packing Glands, Nuts & Bolts, Flange Gasket

SIZE	HV ITEM#	STANDARD BRASS	
		CTN/CASE	CASE WT
H-8142 Series			
FIP × Press × Rotating Flange		250 PSI CWP Max/250°F Max	
1"	H-81424HV	1/10	35

FITS STANDARD & HIGH VELOCITY PUMPS

DOUBLE FLANGED CHECK VALVE

The easiest way to add a check valve to any pump! Two sizes cover all standard Isolator installations.

- Installs between the pump & Isolator
- Limits SKUs and saves space on the truck!
- Outfitted with slotted bolt holes that fit both standard and high velocity pumps
- Replacement check assemblies available

SNUG-FIT ROTATING FLANGE



SECTION REMOVED TO SHOW INTERNAL CONSTRUCTION

ISOLATOR DOUBLE FLANGED CHECK

Forged Brass Check Valve w/ Rotating Flange • Includes One Set of Mounting Bolts & Flange Gasket

SIZE	HV ITEM#	STANDARD BRASS	
		CTN/CASE	CASE WT
H-1370 Series			
Flange × Rotating Flange		150 PSI @ 200°F	
3/4 thru 1 1/4"	H-13703HV	1/10	19
1 1/2 thru 2"	H-13706HV	1/10	20

FITS STANDARD & HIGH VELOCITY PUMPS





STEP SAVING VALVES FOR THE PROFESSIONAL

PATENTED TECHNOLOGY



BALL DRAIN™

- Eliminates assemblies needed to isolate & drain any portion of a piped system
- Press or SWT × FIP options designed specifically for use with pre-fabricated threaded headers
- Avoids reduced-port alternatives
- Creates cleaner-looking, more efficient installations
- Reversible handle for added versatility
- Exclusive adjustable flow path allows for draining from either side of the ball

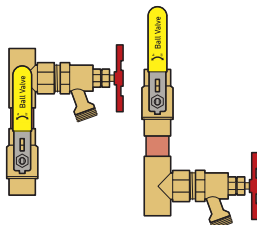

Draining from Above Ball Draining from Below Ball

WORK SMARTER

SAVE
25
MINUTES

ELIMINATE
3
LEAK PATHS

PRO-PAL BALL DRAIN

Full Port Forged Brass Ball Valve w/ Hi-Flow Hose Drain, Reversible Handle & Adjustable Packing Glands

SIZE	STANDARD BRASS			LEAD-FREE BRASS		
	ITEM#	CTN/CASE	CASE WT	ITEM#	CTN/CASE	CASE WT
H-x061 Series						
FIP				600 PSI CWP Max/350°F Max		
1/2"	H-40612	6/36	32	H-40612W	6/36	33
3/4"	H-40613	6/36	41	H-40613W	6/36	41
1"	H-40614	4/24	39	H-40614W	4/24	39
1 1/4"	H-40615	2/12	28	H-40615W	2/12	28
1 1/2"	H-40616	2/12	40	H-40616W	2/8	27
2"	H-40617	1/6	29	H-40617W	1/6	29
SWT				600 PSI CWP Max/250°F Max		
1/2"	H-50612	6/36	30	H-50612W	6/36	30
3/4"	H-50613	6/36	39	H-50613W	6/36	39
1"	H-50614	4/24	38	H-50614W	4/24	37
1 1/4"	H-50615	2/12	27	H-50615W	2/12	27
1 1/2"	H-50616	2/12	40	H-50616W	2/12	41
2"	H-50617	1/6	31	H-50617W	1/6	31
Press				250 PSI CWP Max/250°F Max		
1/2"	H-80612	4/40	39	H-80612W	4/40	38
3/4"	H-80613	4/32	40	H-80613W	4/32	40
1"	H-80614	2/20	35	H-80614W	2/20	35
1 1/4"	H-80615	2/16	43	H-80615W	2/16	43
1 1/2"	H-80616	1/8	29	H-80616W	1/8	29
2"	H-80617	1/6	34	H-80617W	1/6	34
H-x461 Series						
SWT × FIP				500 PSI CWP Max/250°F Max		
1/2"	H-54612	6/36	30	H-54612W	6/36	30
3/4"	H-54613	6/36	39	H-54613W	6/36	39
1"	H-54614	4/24	37	H-54614W	4/24	37
Press × FIP				250 PSI CWP Max/250°F Max		
3/4"	H-84613	4/32	37	-	-	-
1"	H-84614	2/20	33	-	-	-
STANDARD BRASS						
H-x061 Series						
F1960 PEX				400 PSI CWP Max/200°F Max		
1/2"	-	-	-	H-30612W	4/40	34
3/4"	-	-	-	H-30613W	4/32	36
1"	-	-	-	H-30614W	2/20	32
1 1/4"	-	-	-	H-30615W	2/16	40
1 1/2"	-	-	-	H-30616W	1/8	28
2"	-	-	-	H-30617W	1/6	34
F1807 PEX				400 PSI CWP Max/200°F Max		
1/2"	-	-	-	H-10612W	4/40	33
3/4"	-	-	-	H-10613W	4/32	34
1"	-	-	-	H-10614W	2/20	31
1 1/4"	-	-	-	H-10615W	2/16	37
1 1/2"	-	-	-	H-10616W	1/8	26
2"	-	-	-	H-10617W	1/6	30
H-806x Series						
Press × F1960 PEX				250 PSI CWP Max/250°F Max		
1/2"	-	-	-	H-83612W	4/40	37
3/4"	-	-	-	H-83613W	4/32	38
1"	-	-	-	H-83614W	2/20	33
1 1/4"	-	-	-	H-83615W	2/16	42
1 1/2"	-	-	-	H-83616W	1/8	29
2"	-	-	-	H-83617W	1/6	35
Press × F1807 PEX				250 PSI CWP Max/250°F Max		
1/2"	-	-	-	H-81612W	4/40	36
3/4"	-	-	-	H-81613W	4/32	37
1"	-	-	-	H-81614W	2/20	32
1 1/4"	-	-	-	H-81615W	2/16	40
1 1/2"	-	-	-	H-81616W	1/8	28
2"	-	-	-	H-81617W	1/6	34



Adjustable stem directs flow into the hi-flow hose drain from either side of the ball

DRAINING FROM AFTER BALL

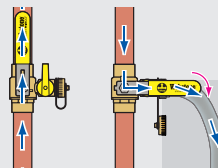

Normal Operation System Purging

DRAINING FROM BEFORE BALL

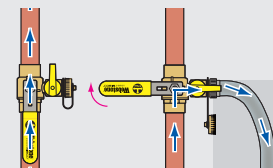

Normal Operation System Purging



SAVE SPACE IN THE FIELD AND IN THE TRUCK

- Create nearly 500 different combinations from a single G-Series Ball Drain body
- Connect different piping types and sizes, right at the valve, without the need for additional adapters
- Save trips to the supply house and create niche configurations on the fly

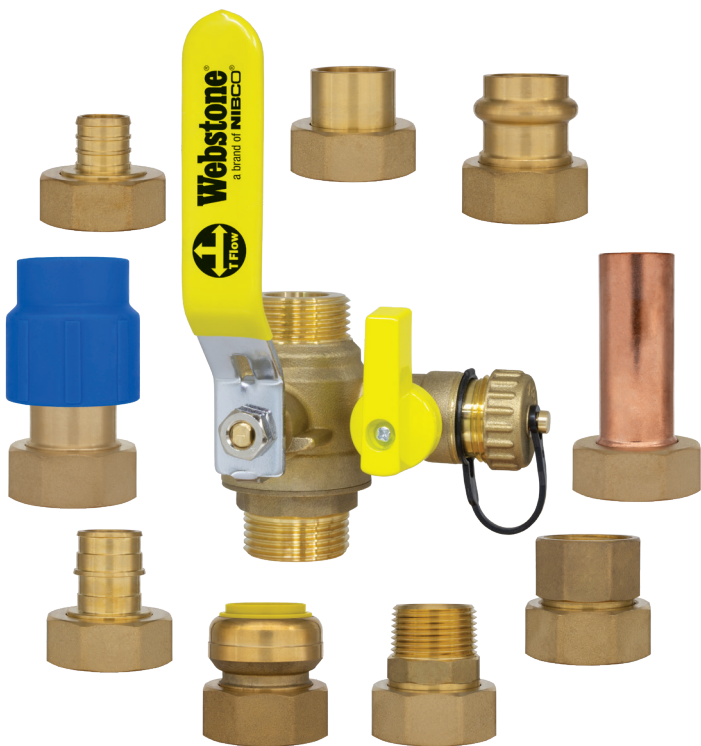

G-SERIES BALL DRAIN

Full Flow Forged DZR Brass Ball Valve w/ Hi-Flow Hose Drain, Reversible Handle, & Adjustable Packing Glands

SIZE	ITEM#	LEAD-FREE BRASS	
		CTN/CASE	CASE WT
H-G-x061 Series			
Body Only • Install w/ (1) G-Union Fitting			
G-Thread × Press		200 PSI CWP Max/200°F Max	
1"	H-G-80614W	1/8	18
1"×1/2"	H-G-80612W	1/16	24
1"×3/4"	H-G-80613W	1/16	28
1 1/2"	H-G-80616W	1/4	19
1 1/2"×1 1/4"	H-G-80616W-R	1/8	29
2"	H-G-80617W	1/4	27



SEE PAGES 4-7



G-SERIES BALL DRAIN

Full Flow Forged DZR Brass Ball Valve w/ Hi-Flow Hose Drain, Reversible Handle, & Adjustable Packing Glands

SIZE	ITEM#	LEAD-FREE BRASS	
		CTN/CASE	CASE WT
H-G061 Series			
Body Only • Install w/ (2) G-Union Fittings			
G-Thread		200 PSI CWP Max/200°F Max	
1"×1"	H-G0614W	1/16	26
1 1/2"	H-G0616W	1/6	22
1 1/2"×1"	H-G0616W-R	1/12	21
2"	H-G0617W	1/4	21
2"×1 1/2"	H-G0617W-R	1/6	21



SEE PAGES 4-7



UNION BALL DRAIN™

- All the features of the ball drain, with an integrated union connection

PRO-PAL UNION BALL DRAIN

Full Port Forged Brass Ball Valve w/ Single Union End, Hi-Flow Hose Drain, Reversible Handle & Adjustable Packing Glands

SIZE	STANDARD BRASS			LEAD-FREE BRASS		
	ITEM#	CTN/CASE	CASE WT	ITEM#	CTN/CASE	CASE WT
H-x043 Series						
FIP Union × FIP				600 PSI CWP Max/350°F Max		
3/4"	H-40433	6/24	40	H-40433W	6/24	40
1"	H-40434	4/16	38	H-40434W	4/16	36
1 1/4"	H-40435	2/12	40	H-40435W	2/12	38
1 1/2"	H-40436	2/12	56	H-40436W	2/8	38
FIP Union × SWT				600 PSI CWP Max/250°F Max		
3/4"	H-50433	6/24	40	H-50433W	6/24	39
1"	H-50434	4/16	36	H-50434W	4/16	35
1 1/4"	H-50435	2/12	38	H-50435W	2/12	38
1 1/2"	H-50436	2/12	56	H-50436W	2/8	38
FIP Union × Press				250 PSI CWP Max/250°F Max		
3/4"	-	-	-	H-80433W	4/16	28
1"	-	-	-	H-80434W	2/16	37
1 1/4"	-	-	-	H-80435W	2/8	27
1 1/2"	-	-	-	H-80436W	1/5	25
STANDARD BRASS				LEAD-FREE BRASS		
FIP Union × F1960 PEX				250 PSI CWP Max/200°F Max		
1/2"	-	-	-	H-30432W	4/16	21
3/4"	-	-	-	H-30433W	4/16	27
1"	-	-	-	H-30434W	2/16	36
1 1/4"	-	-	-	H-30435W	2/8	27
1 1/2"	-	-	-	H-30436W	1/8	38
2"	-	-	-	H-30437W	1/4	28
FIP Union × F1807 PEX				250 PSI CWP Max/200°F Max		
1/2"	-	-	-	H-10432W	4/16	21
3/4"	-	-	-	H-10433W	4/16	26
1"	-	-	-	H-10434W	2/16	35
1 1/4"	-	-	-	H-10435W	2/8	26
1 1/2"	-	-	-	H-10436W	1/8	37
2"	-	-	-	H-10437W	1/4	27

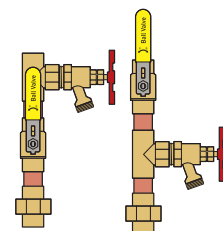

Draining from Above Ball

Draining from Below Ball

WORK SMARTER

SAVE **25** MINUTES

ELIMINATE **3** LEAK PATHS



Winterize an entire building with simple quarter-turn actions

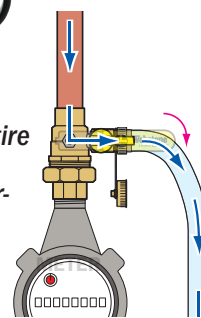

LEAD-FREE: Weighted average lead content ≤ 0.25%

PRO-PAL® STEP SAVING VALVES

ALSO AVAILABLE

TWH SERVICE VALVES
E·X·P
UNION BALL

Ideal for tanked and next-gen tankless water heater connections - See Page 21

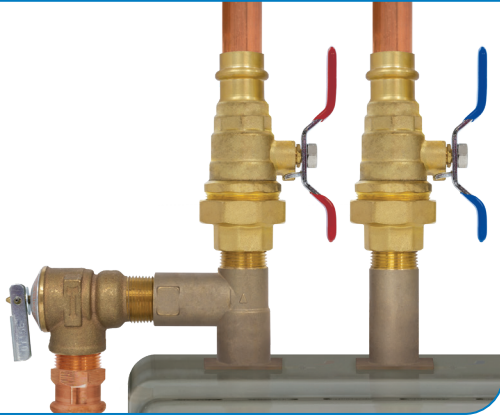

UNION BALL™

- Easily disconnect and replace any portion of a piped system

PRO-PAL UNION BALL
Full Port Forged DZR Brass Ball Valve w/ Single Union End & Adjustable Packing Gland

SIZE	ITEM#	LEAD-FREE BRASS	
		CTN/CASE	CASE WT
H-x042 Series			
FIP Union × FIP		250 PSI CWP Max/200°F Max	
1/2"	H-40422W	5/40	35
3/4"	H-40423W	4/32	41
1"	H-40424W	4/20	37
1 1/4"	H-40425W	4/12	33
1 1/2"	H-40426W	2/8	30
FIP Union × SWT		250 PSI CWP Max/200°F Max	
1/2"	H-50422W	5/40	34
3/4"	H-50423W	4/32	40
1"	H-50424W	4/20	36
1 1/4"	H-50425W	4/12	33
1 1/2"	H-50426W	2/8	30
FIP Union × Press		250 PSI CWP Max/200°F Max	
1/2"	H-80422W	5/40	37
3/4"	H-80423W	4/32	43
1"	H-80424W	4/20	38
1 1/4"	H-80425W	4/12	35
1 1/2"	H-80426W	2/8	31
FIP Union × Push		200 PSI CWP Max/200°F Max	
1/2"	H-60422W	5/40	34
3/4"	H-60423W	4/32	38
1"	H-60424W	4/20	24
FIP Union × F1960 PEX		250 PSI CWP Max/200°F Max	
1/2"	H-30422W	5/40	35
3/4"	H-30423W	4/32	40
1"	H-30424W	4/20	37
FIP Union × F1807 PEX		250 PSI CWP Max/200°F Max	
1/2"	H-10422W	5/40	34
3/4"	H-10423W	4/32	39
1"	H-10424W	4/20	36



WORK SMARTER

SAVE
15
MINUTES

ELIMINATE
2
LEAK PATHS

T-UNION BALL DRAIN™

- Ideal for branch connections and shutoffs in tight locations
- Dual stem seal design incorporates both an O-ring and PTFE packing with adjustable packing gland for extra leak protection

PRO-PAL T-UNION BALL DRAIN
Full Port Forged DZR Brass Ball Valve w/ Union Tee, Hi-Flow Hose Drain, Reversible Handle & Dual Stem Seal Design

SIZE	ITEM#	LEAD-FREE BRASS	
		CTN/CASE	CASE WT
H-x063 Series			
Press Valve × Press Run		250 PSI CWP Max/200°F Max	
3/4" × 1 1/4"	H-80633W-T114	1/12	28
1" × 1 1/4"	H-80634W-T114	1/8	24
1" × 1 1/2"	H-80634W-T112	1/8	26
1 1/4" × 1 1/2"	H-80635W-T112	1/6	23



Draining from Above Ball

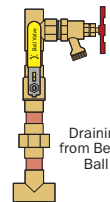

Draining from Below Ball

WORK SMARTER

SAVE
60
MINUTES

ELIMINATE
7
LEAK PATHS

ADJUSTABLE
Exclusive adjustable flow path allows for draining from either side of the ball

T-UNION BALL™

WORK SMARTER

SAVE
35
MINUTES

ELIMINATE
4
LEAK PATHS

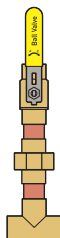

- Ideal for branch connections and shutoffs in tight locations
- Integrated union fitting adds versatility and simplifies installation
- Dual stem seal design incorporates both an O-ring and PTFE packing with adjustable packing gland for extra leak protection

PRO-PAL T-UNION BALL

Full Port Forged DZR Brass Ball Valve w/
Union Tee & Dual Stem Seal Design

SIZE	ITEM#	CTN/CASE	CASE WT
LEAD-FREE BRASS			
H-x371 Series			
Press Valve × Press Run		250 PSI CWP Max/200°F Max	
1/2"	H-83712W	5/40	33
3/4"	H-83713W	5/30	39
3/4" × 1 1/4"	H-83713W-T114	2/16	31
1"	H-83714W	4/16	35
1" × 1 1/4"	H-83714W-T114	2/8	21
1" × 1 1/2"	H-83714W-T112	2/8	23
1 1/4" × 1 1/2"	H-83715W-T112	2/8	29

LEVER HANDLE ON H-83715W-T112

L-UNION BALL™

WORK SMARTER

SAVE
35
MINUTES

ELIMINATE
4
LEAK PATHS

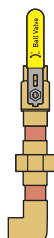

- Ideal for shutoffs in tight locations
- Integrated union fitting adds versatility and simplifies installation
- Dual stem seal design incorporates both an O-ring and PTFE packing with adjustable packing gland for extra leak protection

PRO-PAL L-UNION BALL

Full Port Forged DZR Brass Ball Valve w/ 90°
Union Elbow & Dual Stem Seal Design

SIZE	ITEM#	CTN/CASE	CASE WT
LEAD-FREE BRASS			
H-x271 Series			
Press		250 PSI CWP Max/200°F Max	
1/2"	H-82712W	5/40	31
3/4"	H-82713W	5/30	36
1"	H-82714W	4/16	32

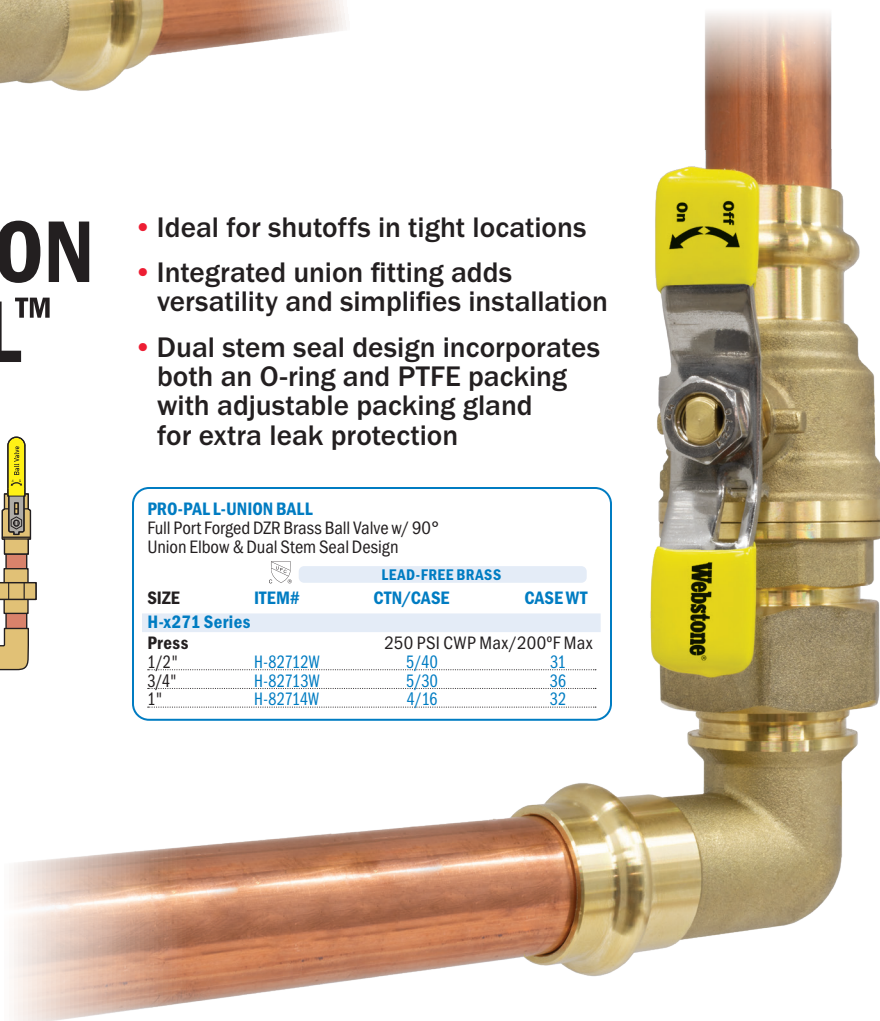
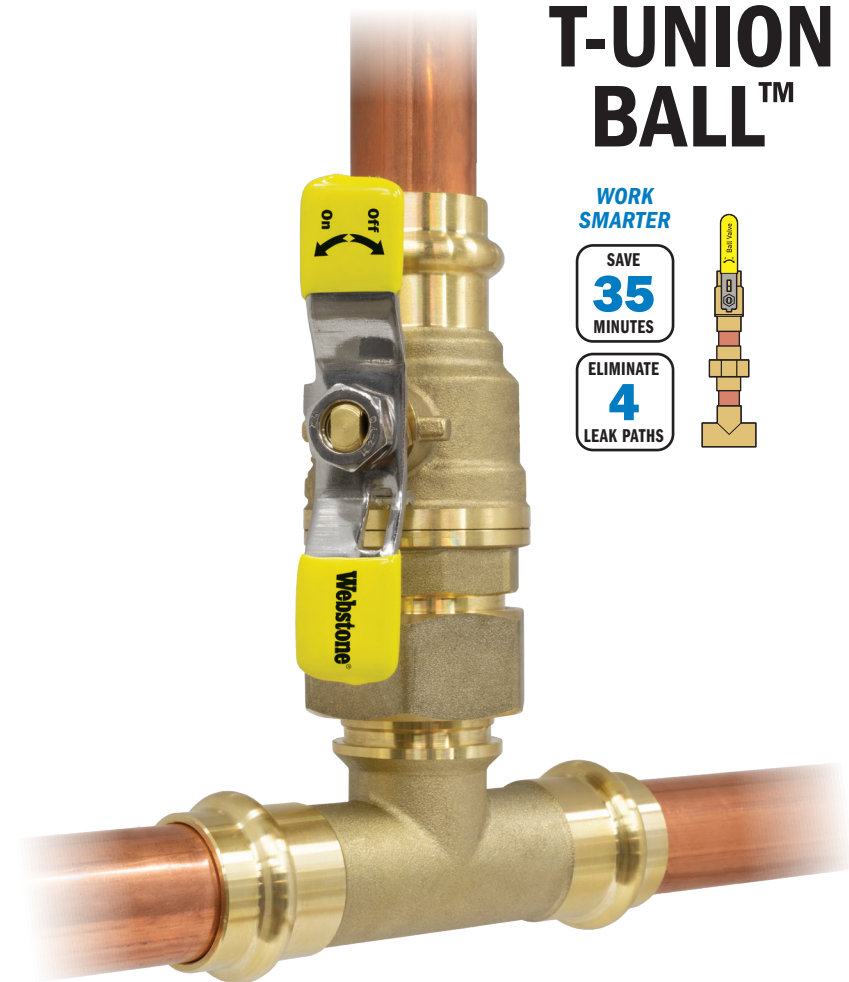

3-WAY L-PORT BALL VALVE

- Divert or select fluids based on application needs
- Dual stem seal design incorporates both an O-ring and PTFE packing with adjustable packing gland for extra leak protection



90° HANDLE OPERATION
Ideal for use as a diverter or selector valve

WORK SMARTER

SAVE **35** MINUTES

ELIMINATE **4** LEAK PATHS



Bypass a water filter with two turns

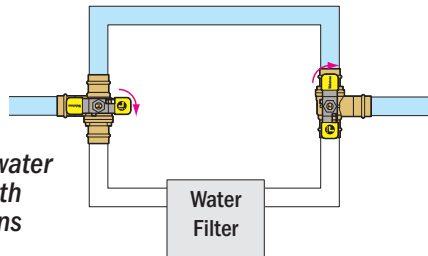

PRO-PAL 3-WAY L-PORT BALL VALVE

Forged DZR Brass Ball Valve w/ Dual Stem Seal Design

SIZE	ITEM#	LEAD-FREE BRASS	
		CTN/CASE	CASE WT
H-x064 Series			
Press		250 PSI CWP Max/200°F Max	
1/2"	H-80642W	6/36	20
3/4"	H-80643W	6/36	33
1"	H-80644W	4/24	34
1 1/4"	H-80645W	2/12	28
1 1/2"	H-80646W	2/8	29
2"	H-80647W	1/6	39

LEVER HANDLE ON SIZES 1 1/4" - 2"

3-WAY T-FLOW BALL VALVE

- Divert, select, or mix fluids based on application needs
- Dual stem seal design incorporates both an O-ring and PTFE packing with adjustable packing gland for extra leak protection



PRO-PAL 3-WAY T-FLOW BALL VALVE

Forged DZR Brass Ball Valve w/ Dual Stem Seal Design

SIZE	ITEM#	LEAD-FREE BRASS	
		CTN/CASE	CASE WT
H-x074 Series			
Press		250 PSI CWP Max/200°F Max	
1/2"	H-80742W	6/36	20
3/4"	H-80743W	6/36	31
1"	H-80744W	4/24	33
1 1/4"	H-80745W	2/12	26
1 1/2"	H-80746W	2/8	27
2"	H-80747W	1/6	37

LEVER HANDLE ON SIZES 1 1/4" - 2"

180° HANDLE OPERATION
Ideal for use as a diverter, selector, or mixing valve

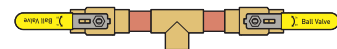

WORK SMARTER

SAVE **35** MINUTES

ELIMINATE **4** LEAK PATHS

T-VALVE™

**TWO DESIGNS COVER
A WIDE RANGE OF
APPLICATIONS**

- Ideal for branch or device connections in tight locations
- Lead-free DZR brass construction
- Replaces multiple components
- Saves labor, space, and leak paths
- Adjustable packing gland
- Reversible handle on select models

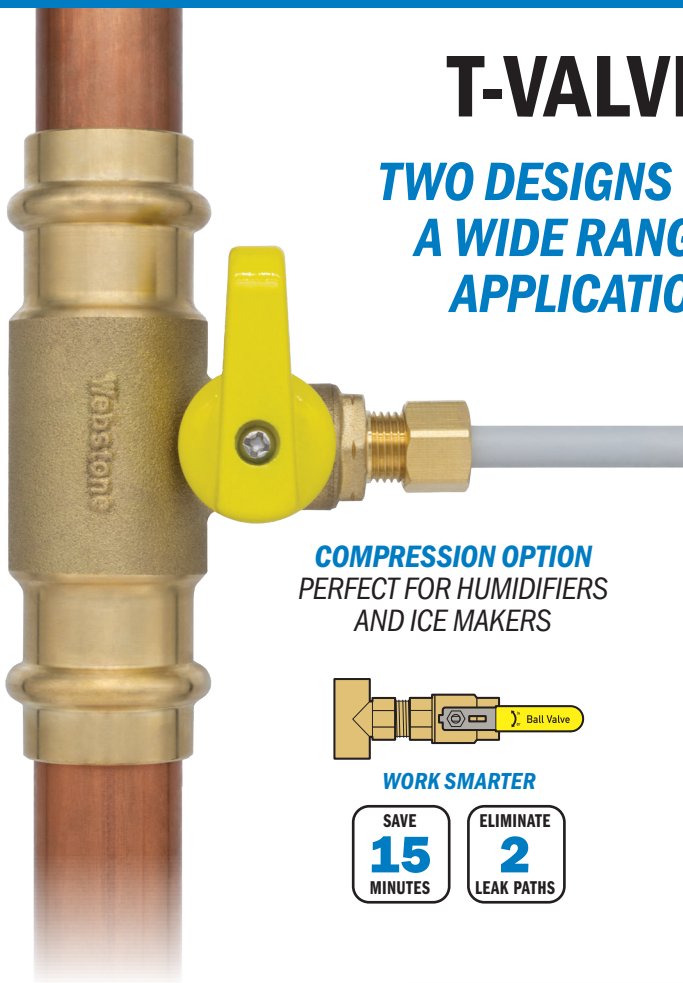

COMPRESSION OPTION
PERFECT FOR HUMIDIFIERS
AND ICE MAKERS

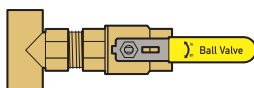

WORK SMARTER

SAVE
15
MINUTES

ELIMINATE
2
LEAK PATHS

PRO-PAL-T-VALVE

Forged DZR Brass Ball Valve w/ Integrated Tee Fitting, Adjustable Packing Gland

SIZE	ITEM#	LEAD-FREE BRASS	
		CTN/CASE	CASE WT
H-x267 Series			
OD Comp Valve × Press Run		125 PSI CWP Max/150°F Max	
1/4" × 1/2"	H-80670W-T12	8/96	39
1/4" × 3/4"	H-80670W-T34	6/48	26
3/8" × 1/2"	H-80671W-T12	8/96	39
3/8" × 3/4"	H-80671W-T34	6/48	26
OD Comp Valve × Push Run			
1/4" × 1/2"	H-60670W-T12	8/96	32
1/4" × 3/4"	H-60670W-T34	6/48	20
3/8" × 1/2"	H-60671W-T12	8/96	31
3/8" × 3/4"	H-60671W-T34	6/48	20
OD Comp Valve × F1960 PEX Run			
3/8" × 1/2"	H-30671W-T12	8/96	29
3/8" × 3/4"	H-30671W-T34	6/48	19
OD Comp Valve × F1807 PEX Run			
3/8" × 1/2"	H-10671W-T12	8/96	27
3/8" × 3/4"	H-10671W-T34	8/96	26



- Lead-free full port forged DZR brass construction
- Replaces multiple components
- Saves labor, space, and leak paths
- Adjustable packing gland
- Reversible handles
- Available G-Series models for a custom installation

FULL-PORT OPTION
IDEAL FOR EXPANSION
TANK AND RETURN
HEADER CONNECTIONS

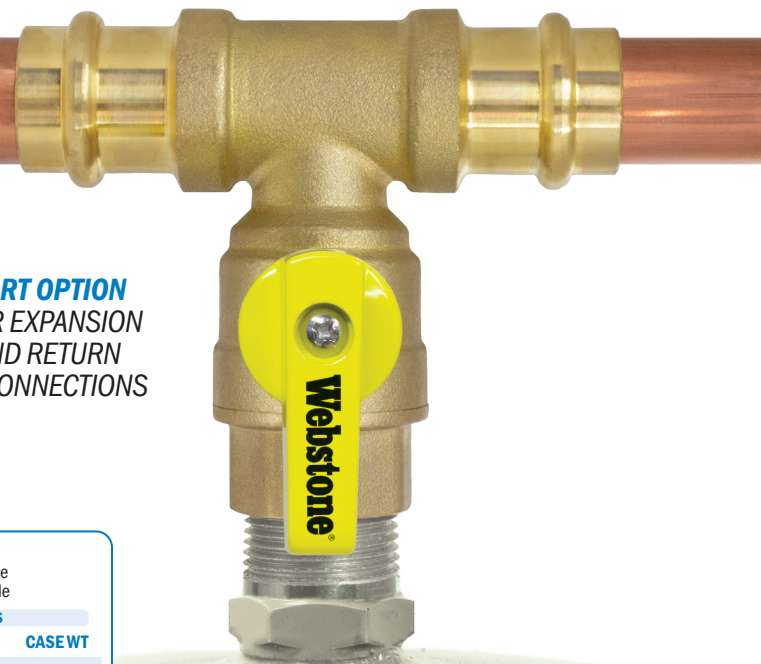

PRO-PAL-T-VALVE

Full Port Forged DZR Brass Ball Valve w/ Integrated Tee Fitting, Adjustable Packing Gland, & Reversible Handle

SIZE	ITEM#	LEAD-FREE BRASS	
		CTN/CASE	CASE WT
H-x267 Series			
FIP Valve × Press Run		250 PSI CWP Max/250°F Max	
1/2"	H-82672W	4/40	24
1/2" × 3/4"	H-82672W-T34	4/16	16
3/4"	H-82673W	4/16	16
3/4" × 1/2"	H-82673W-T12	4/40	34
1"	H-82674W	2/16	26
1" × 1 1/4"	H-82674W-T114	2/16	30
1 1/4"	H-82675W	2/16	41
H-G767 Series			
Body Only • Install w/ (3) G-Union Fittings			
G-Thread Valve × G-Thread Run		200 PSI CWP Max/200°F Max	
1"	H-G7674W	1/12	23
1" × 1 1/2"	H-G7674W-T112	1/12	30
1 1/2"	H-G7676W	1/8	30



SEE PAGES 4-7

PURGE & FILL™



- Simultaneously drain, flush & refill any hydronic, solar, or closed loop system
- T-pattern flow path quickly and easily prevents the flow between the two hose connections
- As fluid is introduced into the system, the existing fluid or air is diverted out of the system through the remaining hose connection

WORK SMARTER

SAVE
50
MINUTES

ELIMINATE
6
LEAK PATHS

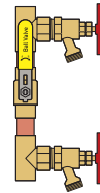

SIMULTANEOUSLY
DRAIN, FLUSH & FILL

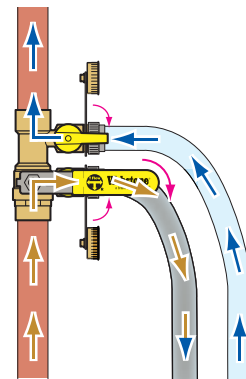

PRO-PAL PURGE & FILL

Full Port Forged Brass Ball Valve w/ (2) Hi-Flow Hose Drains, Reversible Handle & Adjustable Packing Glands

SIZE	ITEM#	STANDARD BRASS	
		CTN/CASE	CASE WT
H-x861 Series			
FIP		600 PSI CWP Max/250°F Max	
3/4"	H-48613	1/12	20
1"	H-48614	1/12	26
1 1/4"	H-48615	1/12	38
1 1/2"	H-48616	1/12	49
SWT		600 PSI CWP Max/250°F Max	
3/4"	H-58613	1/12	23
1"	H-58614	1/12	26
1 1/4"	H-58615	1/12	38
1 1/2"	H-58616	1/12	51
Press		250 PSI CWP Max/250°F Max	
3/4"	H-88613	1/12	20
1"	H-88614	1/12	27
1 1/4"	H-88615	1/12	40
1 1/2"	H-88616	1/6	27

T-DRAIN™

- Installs anywhere a drain or purge valve is required
- Hi-flow alternative for filling, draining, or venting closed-loop hydronic systems

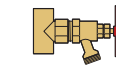

WORK SMARTER

SAVE
5
MINUTES

ELIMINATE
1
LEAK PATH

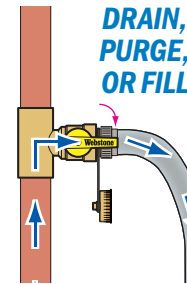

DRAIN,
PURGE,
OR FILL

PRO-PAL T-DRAIN

Full Port Forged Brass Fitting w/ Hi-Flow Hose Drain & Adjustable Packing Gland

SIZE	ITEM#	LEAD-FREE BRASS	
		CTN/CASE	CASE WT
H-x067 Series			
SWT		600 PSI CWP Max/250°F Max	
1/2"	H-50672W	8/80	40
3/4"	H-50673W	6/48	38
1"	H-50674W	4/40	36
1 1/4"	H-50675W	4/40	44
1 1/2"	H-50676W	2/24	34
2"	H-50677W	2/20	34
Press		250 PSI CWP Max/250°F Max	
1/2"	H-80672W	4/40	27
3/4"	H-80673W	4/16	17
1"	H-80674W	4/16	18
1 1/4"	H-80675W	4/16	21

ADD-A-GAUGE

TO ANY STANDARD HOSE CONNECTION IN JUST MINUTES

- Suitable for temporary or permanent gauge installation
- Utilize any hose connection as a gauge port

PRO-PAL ADD-A-GAUGE

Forged Brass Hose Fitting w/ 1/8" Bleeder (Capped) • For Connection to Temperature/Pressure Gauge

SIZE	ITEM#	LEAD-FREE BRASS	
		CTN/CASE	CASE WT
H-30000-P Series			
Hose		250 PSI CWP Max/250°F Max	
3/4"	H-30000W-TP	10/100	27



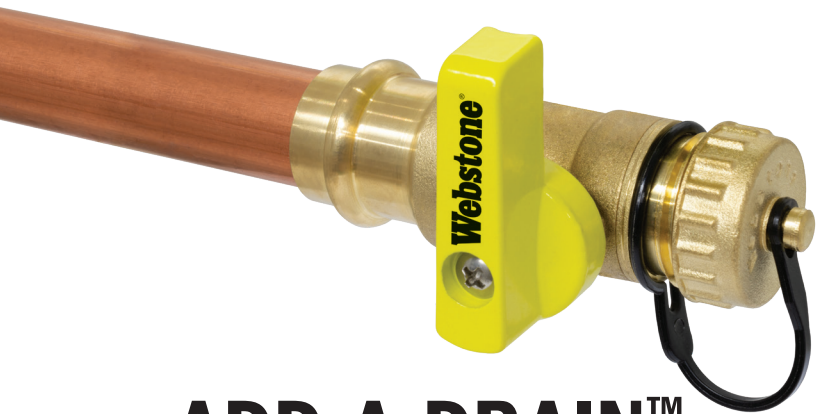

ADD-A-DRAIN™

- Add a hose connection to appliances or the end of any line
- Hi-flow, quarter-turn alternative to traditional boiler drains
- Straight design for more convenient service access
- Compact handle saves space
- Lead-free forged DZR brass suitable for hydronic or potable applications



SEE PAGES 4-7

PRO-PAL ADD-A-DRAIN

Hi-Flow Forged DZR Brass Ball Valve, w/ Cap & Strap & Adjustable Packing Gland

SIZE	ITEM#	LEAD-FREE BRASS	
		CTN/CASE	CASE WT
H-x030 Series			
FIP × Hose		250 PSI CWP Max/250°F Max	
1/2" × 3/4"	H-40302W	12/72	33
3/4" × 3/4"	H-40303W	12/72	35
1" × 3/4"	H-40304W	8/64	39
1 1/4" × 3/4"	H-40305W	6/48	40
1 1/2" × 3/4"	H-40306W	6/36	35
MIP × Hose		250 PSI CWP Max/250°F Max	
1/2" × 3/4"	H-20302W	12/72	31
3/4" × 3/4"	H-20303W	12/72	36
1" × 3/4"	H-20304W	8/64	39
1 1/4" × 3/4"	H-20305W	6/48	33
1 1/2" × 3/4"	H-20306W	6/36	36
SWT × Hose		250 PSI CWP Max/250°F Max	
1/2" × 3/4"	H-50302W	12/72	29
3/4" × 3/4"	H-50303W	12/72	33
1" × 3/4"	H-50304W	8/64	33
1 1/4" × 3/4"	H-50305W	6/48	37
1 1/2" × 3/4"	H-50306W	6/36	34
Press × Hose		250 PSI CWP Max/250°F Max	
1/2" × 3/4"	H-80302W	12/72	33
3/4" × 3/4"	H-80303W	12/72	38
1" × 3/4"	H-80304W	8/64	37
1 1/4" × 3/4"	H-80305W	6/48	38
1 1/2" × 3/4"	H-80306W	6/36	38
H-G030 Series			
Body Only • Install w/ (1) G-Union Fitting			
G-Thread × Hose		250 PSI CWP Max/250°F Max	
1" × 3/4"	H-G0304W	8/64	38
1 1/2" × 3/4"	H-G0306W	6/36	35



HOSE DRAIN VALVES

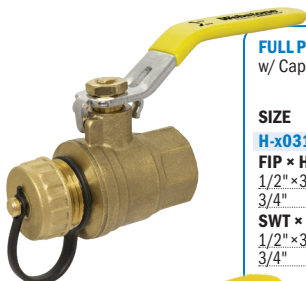

FULL PORT FORGED BRASS BALL VALVE			
w/ Cap & Strap, Reversible Handle & Adjustable Packing Gland			
SIZE	ITEM#	LEAD-FREE BRASS	
		CTN/CASE	CASE WT
H-x031 Series			
FIP × Hose		600 PSI CWP Max/150 WSP	
1/2" × 3/4"	H-40312W	10/60	31
3/4"	H-40313W	10/60	45
SWT × Hose		600 PSI CWP Max/150 WSP	
1/2" × 3/4"	H-50312W	10/100	52
3/4"	H-50313W	10/60	45
SIZE	ITEM#	LEAD-FREE BRASS	
		CTN/CASE	CASE WT
Press × Hose		250 PSI CWP Max/250°F Max	
1/2" × 3/4"	H-80312W	5/50	29
3/4"	H-80313W	5/40	32



FULL FLOW FORGED BRASS SILLCOCK			
Nickel-Plated w/ 1/4 Turn Handle			
SIZE	ITEM#	LEAD-FREE BRASS	
		CTN/CASE	CASE WT
H-Sillcock Series			
F1960 PEX Flange × Hose		125 PSI CWP Max	
1/2"	H-33202WSSL	12/72	58



FORGED BRASS HOSE BIBB			
w/ Ball Valve Action			
SIZE	ITEM#	LEAD-FREE BRASS	
		CTN/CASE	CASE WT
H-Hosebibb Series			
MIP × Hose		125 PSI CWP Max	
1/2"	H-30314W	12/72	41
3/4"	H-30316W	12/72	43

1/2" MIP OR SWT × HOSE



BRASS HOSE BIBB			
No Kink w/ 1/4 Turn Handle			
SIZE	ITEM#	LEAD-FREE BRASS	
		CTN/CASE	CASE WT
H-Hosebibb Series			
MIP × Hose		125 PSI CWP Max	
1/2"	H-30218W	12/72	25
3/4"	H-30219W	12/72	28

1/2" MIP OR SWT × HOSE

FORGED BRASS SILLCOCK

Nickel-Plated w/ 1/4 Turn Handle

SIZE	ITEM#	LEAD-FREE BRASS	
		CTN/CASE	CASE WT
H-Sillcock Series			
FIP Flange × Hose		125 PSI CWP Max	
1/2"	H-30202W	12/72	43
3/4"	H-30203W	12/72	63



SERVICEABLE DESIGN SPRING CHECK VALVES



SEE PAGES 4-7

Combine body with your choice of G-Union fittings to transition between piping materials and sizes



- Dual-union ends allow easy removal for service
- Stainless steel spring
- Choice of six end connection styles
- 1/2" to 1 1/2" sizes
- Compatible with full range of G-Union accessories including isolation valves, elbows, gauges

SWING CHECK

FORGED BRASS SWING CHECK VALVE

Hard Seat

SIZE	ITEM#	CTN/CASE	CASE WT
H-1054 Series			
FIP		200 PSI CWP Max/125 WSP	
1/4"	H-10540W	12/120	27
3/8"	H-10541W	10/120	35
1/2"	H-10542W	10/120	46
3/4"	H-10543W	10/80	45
1"	H-10544W	5/60	51
1 1/4"	H-10545W	5/40	60
1 1/2"	H-10546W	5/30	60
2"	H-10547W	2/12	34
3"	H-10549W	1/8	61
SWT			
1/2"	H-10622W	10/120	42
3/4"	H-10623W	10/80	42
1"	H-10624W	5/60	47
1 1/4"	H-10625W	5/40	58
1 1/2"	H-10626W	5/30	64
2"	H-10627W	2/10	32

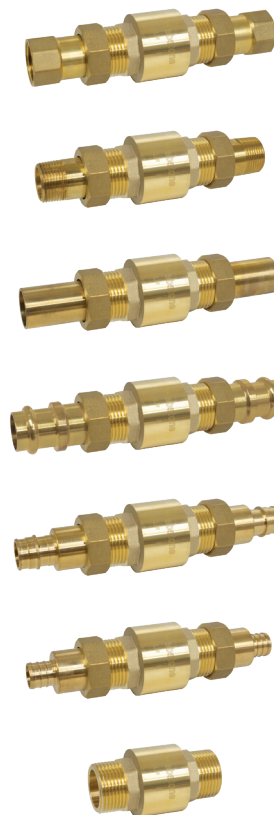
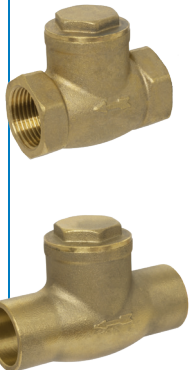

FORGED DZR BRASS IN-LINE SPRING CHECK VALVE

Serviceable Design w/ Dual Union Ends, Stainless Steel Spring • Soft Seat

SIZE	ITEM#	CTN/CASE	CASE WT
H-108x Series			
FIP		200 PSI CWP Max/200°F Max	
1/2"	H-10842W	1/24	12
3/4"	H-10843W	1/24	12
1"	H-10844W	1/24	18
1 1/4"	H-10845W	1/12	16
1 1/2"	H-10846W	1/12	19
MIP			
1/2"	H-10822W	1/24	12
3/4"	H-10823W	1/24	12
1"	H-10824W	1/24	18
1 1/4"	H-10825W	1/12	16
1 1/2"	H-10826W	1/12	19
SWT			
1/2"	H-10852W	1/24	32
3/4"	H-10853W	1/24	33
1"	H-10854W	1/24	37
1 1/4"	H-10855W	1/12	28
1 1/2"	H-10856W	1/12	34
Press			
1/2"	H-10882W	1/24	34
3/4"	H-10883W	1/24	37
1"	H-10884W	1/24	37
1 1/4"	H-10885W	1/12	35
1 1/2"	H-10886W	1/12	42
F1960 PEX			
1/2"	H-10832W	1/24	31
3/4"	H-10833W	1/24	32
1"	H-10834W	1/24	22
F1807 PEX			
1/2"	H-10812W	1/24	35
3/4"	H-10813W	1/24	35
1"	H-10814W	1/24	22
H-108G Series			
Body Only • Install w/ (2) G-Union Fittings			
G-Thread			
1"	H-108G4W	1/24	22
1 1/2"	H-108G6W	1/12	24



BALL CHECK™

- Ball valve with integral spring check saves labor, space, and leak paths
- Reversible handle for additional flexibility
- Dual stem seal design for added protection

PRO-PAL BALL CHECK

Forged DZR Brass Valve w/ Integrated Spring Check Valve, Reversible Handle & Dual Stem Seal Design

SIZE	ITEM#	LEAD-FREE BRASS	
		CTN/CASE	CASE WT
H-x069 Series			
Press		250 PSI CWP Max/250°F Max	
1/2"	H-80692W	6/24	13
3/4"	H-80693W	6/24	22
1"	H-80694W	4/16	24
1 1/4"	H-80695W	2/8	18
1 1/2"	H-80696W	2/8	26

IN-LINE SPRING CHECK VALVES



- Suitable for hydronic and potable water applications
- Stainless steel spring & soft seat

FORGED DZR BRASS IN-LINE SPRING CHECK VALVE

Stainless Steel Spring • Soft Seat

SIZE	ITEM#	LEAD-FREE BRASS	
		CTN/CASE	CASE WT
H-107x Series			
FIP		200 PSI CWP Max/250°F Max	
3/8"	H-10741W	10/100	33
1/2"	H-10742W	10/100	38
3/4"	H-10743W	10/60	32
1"	H-10744W	10/40	34
1 1/4"	H-10745W	6/24	33
1 1/2"	H-10746W	6/24	38
2"	H-10747W	6/12	28
SWT			
3/8"	H-10751W	10/100	29
1/2"	H-10752W	10/100	30
3/4"	H-10753W	10/60	27
1"	H-10754W	10/40	28
1 1/4"	H-10755W	6/24	29
1 1/2"	H-10756W	6/24	34
2"	H-10757W	6/12	27
Press			
1/2"	H-10782W	10/60	26
3/4"	H-10783W	10/40	26
1"	H-10784W	6/24	22
1 1/4"	H-10785W	6/12	18
1 1/2"	H-10786W	6/12	23
2"	H-10787W	6/12	33
F1960 PEX			
1/2"	H-10732W	10/100	33
3/4"	H-10733W	10/60	32
1"	H-10734W	10/40	34
1 1/4"	H-10735W	6/24	26
F1807 PEX			
1/2"	H-10712W	10/100	31
3/4"	H-10713W	10/60	20
1"	H-10714W	10/40	20
1 1/4"	H-10715W	6/24	19



IDEAL FOR RECIRCULATION LOOPS

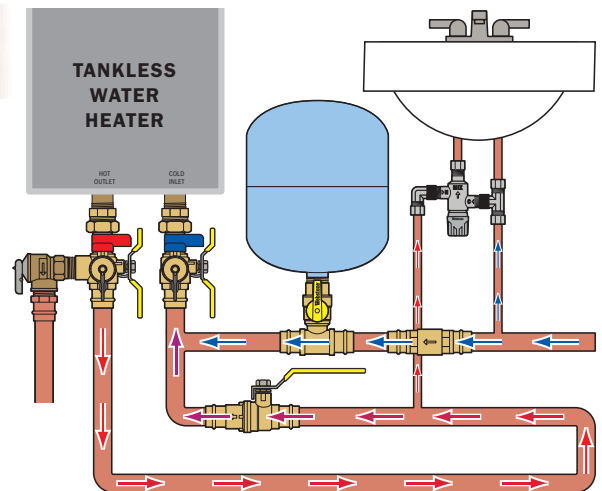

PROPUSH™ CHECK

PRO-CONNECT
PROPUSH
FOR USE
W/ COPPER,
CPVC, & PEX



PROPUSH IN-LINE SPRING CHECK VALVE

Forged DZR Brass Fitting

SIZE	ITEM#	LEAD-FREE BRASS	
		CTN/CASE	CASE WT
H-2699 Series			
Push		200 PSI CWP Max/200°F Max	
1/2"	H-26992W-B	6/120	20
3/4"	H-26993W	12/120	39
1"	H-26994W-B	3/45	25

TRANSITION FITTINGS

- Lead-free brass construction
- Eliminate multiple fittings and adapters
- Save space and eliminate leak paths
- Press connections compatible with popular press tools
- PEX connections available with F1960 Cold Expansion or F1807 Crimp/Clamp connections
- FIP and MIP connections easily transition between copper and threaded pipe

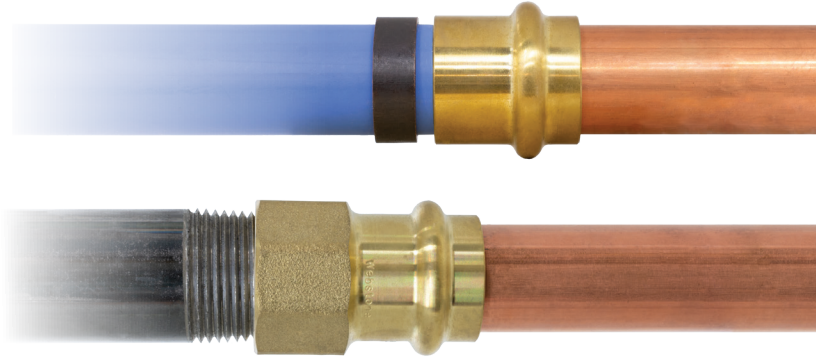

FORGED DZR BRASS TRANSITION FITTING			
		LEAD-FREE BRASS	
SIZE	ITEM#	CTN/CASE	CASE WT
H-x680 Series			
Press x F1960 PEX		250 PSI CWP Max/250°F Max	
1/2"	H-36802W	30/120	12
3/4"	H-36803W	30/120	20
3/4" x 1/2"	H-36803W-R	30/120	17
3/4" x 5/8"	H-36803W-R58	30/120	18
3/4" x 1"	H-36804W-RX	30/120	26
1"	H-36804W	30/120	29
1" x 3/4"	H-36804W-R	30/120	23
1 1/4"	H-36805W	20/80	32
1 1/2"	H-36806W	20/80	46
2"	H-36807W	9/27	29
Press x F1807 PEX			
1/2"	H-16802W	30/120	10
3/4"	H-16803W	30/120	16
3/4" x 1/2"	H-16803W-R	30/120	15
3/4" x 5/8"	H-16803W-R58	30/120	15
3/4" x 1"	H-16804W-RX	30/120	20
1"	H-16804W	30/120	21
1" x 3/4"	H-16804W-R	30/120	20
1 1/4"	H-16805W	20/80	21
1 1/2"	H-16806W	20/80	35
2"	H-16807W	9/27	15



FORGED DZR BRASS TRANSITION FITTING			
		LEAD-FREE BRASS	
SIZE	ITEM#	CTN/CASE	CASE WT
H-86x0 Series			
Press x FIP		250 PSI CWP Max/250°F Max	
1/2"	H-86402W	30/120	14
1/2" x 3/8"	H-86402W-R	30/120	11
1/2" x 3/4"	H-86402W-RX	30/120	18
3/4"	H-86403W	30/120	23
3/4" x 1/2"	H-86403W-R	30/120	18
3/4" x 1"	H-86403W-RX	30/120	30
1"	H-86404W	30/120	31
1" x 3/4"	H-86404W-R	30/120	26
Press x MIP			
1/2"	H-86202W	30/120	13
1/2" x 3/8"	H-86202W-R	30/120	11
1/2" x 3/4"	H-86202W-RX	30/120	18
3/4"	H-86203W	30/120	22
3/4" x 1/2"	H-86203W-R	30/120	18
3/4" x 1"	H-86203W-RX	30/120	33
1"	H-86204W	22/88	34
1" x 3/4"	H-86204W-R	30/120	23

MORE TRANSITION SOLUTIONS FOR ANY INSTALLATION

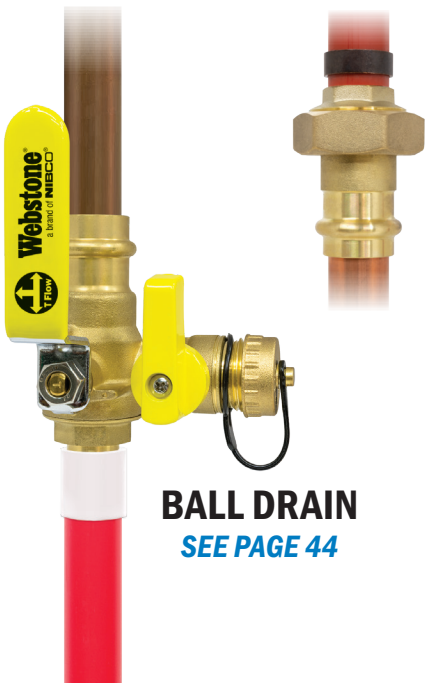

BALL DRAIN
SEE PAGE 44



UNIONS
SEE PAGE 17

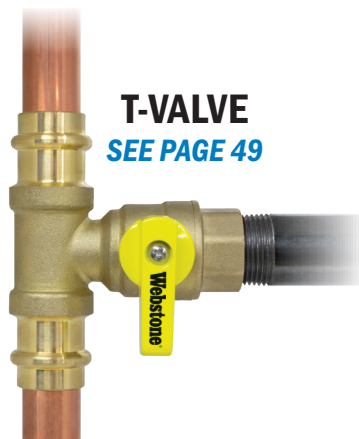

T-VALVE
SEE PAGE 49

BALL VALVES
SEE PAGE 63



Create nearly 500 different combinations from a single body

SEE PAGE 4

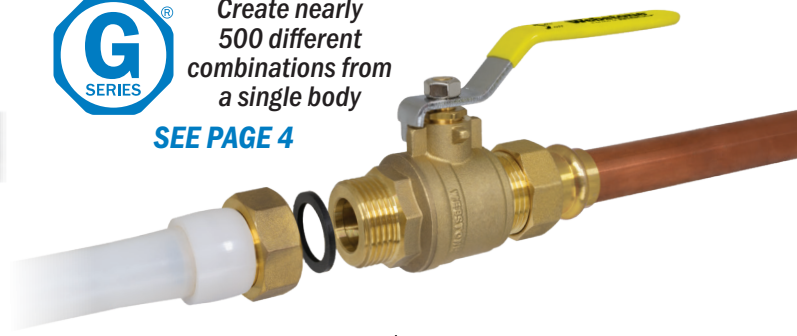

TRANSITION ELBOWS

PATENTED TECHNOLOGY

FORGED DZR BRASS 90° TRANSITION ELBOW

LEAD-FREE BRASS			
SIZE	ITEM#	CTN/CASE	CASE WT
H-x684 Series			
Press x F1960 PEX		250 PSI CWP Max/250°F Max	
1/2"	H-36842W	32/128	16
3/4"	H-36843W	32/128	33
3/4" x 1/2"	H-36843W-R	32/128	24
3/4" x 5/8"	H-36843W-R58	32/128	30
3/4" x 1"	H-36844W-RX	32/128	35
1"	H-36844W	32/128	53
1" x 3/4"	H-36844W-R	32/128	41
1 1/4"	H-36845W	18/54	40
1 1/2"	H-36846W	18/54	49
2"	H-36847W	8/16	17
Press x F1807 PEX			
1/2"	H-16842W	10/130	14
3/4"	H-16843W	32/128	28
3/4" x 1/2"	H-16843W-R	32/128	22
3/4" x 5/8"	H-16843W-R58	32/128	26
3/4" x 1"	H-16844W-RX	32/128	26
1"	H-16844W	32/128	46
1" x 3/4"	H-16844W-R	32/128	38
1 1/4"	H-16845W	18/54	36
1 1/2"	H-16846W	18/54	120
2"	H-16847W	8/16	26

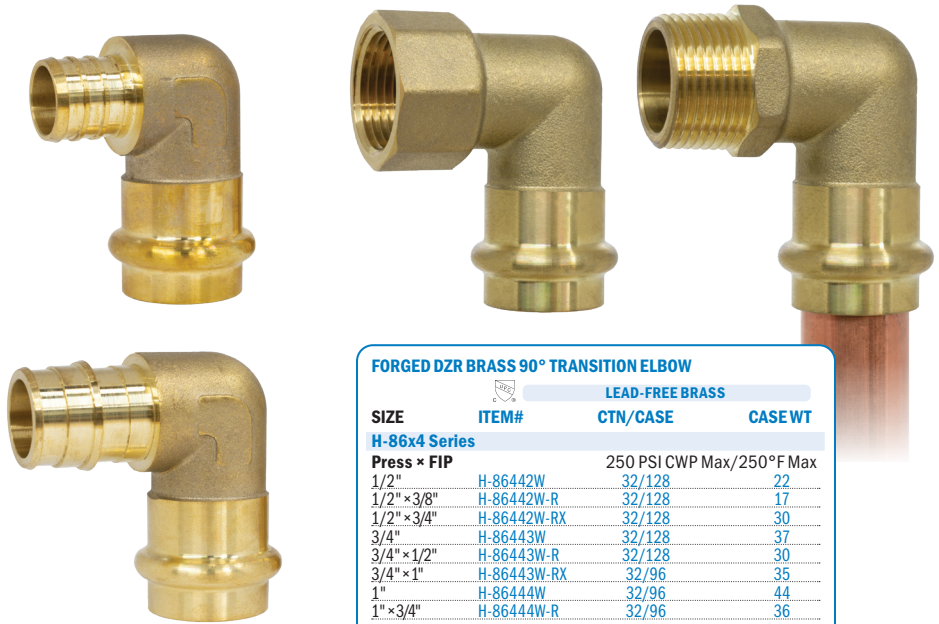

FORGED DZR BRASS 90° TRANSITION ELBOW

LEAD-FREE BRASS			
SIZE	ITEM#	CTN/CASE	CASE WT
H-86x4 Series			
Press x FIP		250 PSI CWP Max/250°F Max	
1/2"	H-86442W	32/128	22
1/2" x 3/8"	H-86442W-R	32/128	17
1/2" x 3/4"	H-86442W-RX	32/128	30
3/4"	H-86443W	32/128	37
3/4" x 1/2"	H-86443W-R	32/128	30
3/4" x 1"	H-86443W-RX	32/96	35
1"	H-86444W	32/96	44
1" x 3/4"	H-86444W-R	32/96	36
Press x MIP			
1/2"	H-86242W	32/128	21
1/2" x 3/8"	H-86242W-R	32/128	18
1/2" x 3/4"	H-86242W-RX	32/128	28
3/4"	H-86243W	32/128	37
3/4" x 1/2"	H-86243W-R	32/128	31
3/4" x 1"	H-86243W-RX	32/96	36
1"	H-86244W	32/96	44
1" x 3/4"	H-86244W-R	32/128	44

DUAL VENT TRANSITION ELBOW

- For use with the 1/8" NPT vent of your choice
- Includes stiffener for copper finned tube press connections

FORGED DZR BRASS DUAL VENT TRANSITION ELBOW

w/ 3/4" Copper Finned Tube Stiffener & 1/8" NPT Plug

LEAD-FREE BRASS			
SIZE	ITEM#	CTN/CASE	CASE WT
H-x683 Series			
Press x F1960 PEX		250 PSI CWP Max/250°F Max	
3/4"	H-36833W	32/128	34
3/4" x 1/2"	H-36833W-R	32/128	27
3/4" x 5/8"	H-36833W-R58	32/128	38
Press x F1807 PEX			
3/4"	H-16833W	32/128	30
3/4" x 1/2"	H-16833W-R	32/128	25
3/4" x 5/8"	H-16833W-R58	32/128	34

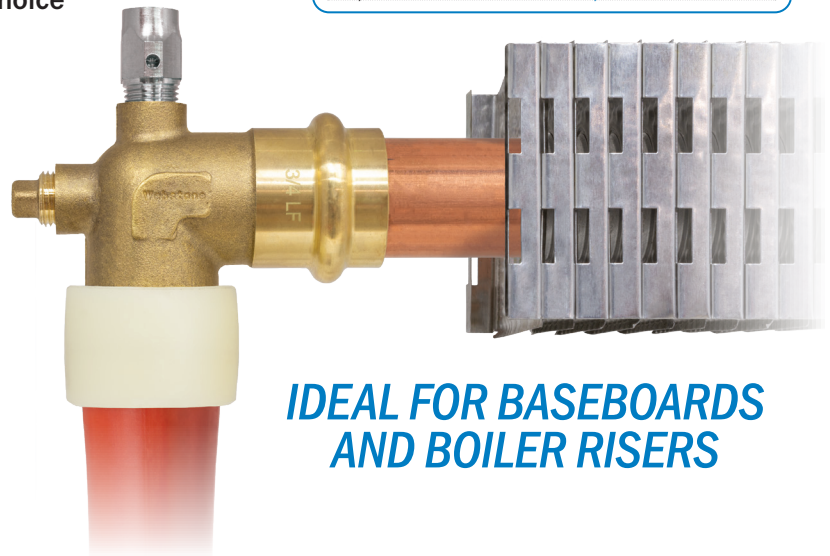

IDEAL FOR BASEBOARDS AND BOILER RISERS

TRANSITION ELBOW W/ BASEBOARD STIFFENER

FORGED DZR BRASS TRANSITION ELBOW

w/ 3/4" Copper Finned Tube Stiffener

LEAD-FREE BRASS			
SIZE	ITEM#	CTN/CASE	CASE WT
H-x682 Series			
Press x F1960 PEX		250 PSI CWP Max/250°F Max	
3/4"	H-36823W	32/128	41
3/4" x 1/2"	H-36823W-R	32/128	28
3/4" x 5/8"	H-36823W-R58	32/128	32
3/4" x 1"	H-36824W-RX	32/128	40
Press x F1807 PEX			
3/4"	H-16823W	32/128	30
3/4" x 1/2"	H-16823W-R	32/128	26
3/4" x 5/8"	H-16823W-R58	32/128	26
3/4" x 1"	H-16824W-RX	32/128	29

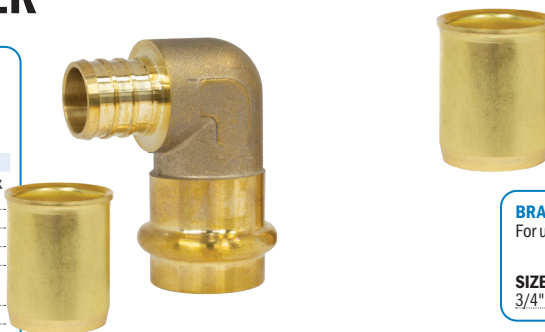

PRESS STIFFENER

- Required for making copper finned tube press connections

BRASS STIFFENER

For use with Copper Finned Tube

LEAD-FREE BRASS			
SIZE	ITEM#	CTN/CASE	CASE WT
3/4"	H-28303W	100/400	13

TRANSITION TEES

FORGED DZR BRASS TRANSITION TEE

LEAD-FREE BRASS			
SIZE	ITEM#	CTN/CASE	CASE WT
H-86x5 Series			
Press × Press × F1960 PEX		250 PSI CWP Max/250°F Max	
1/2"	H-86352W	25/100	18
3/4"	H-86353W	20/80	27
3/4" × 3/4" × 1/2"	H-86353W-R	20/80	22
1"	H-86354W	20/80	45
1" × 1" × 3/4"	H-86354W-R	20/80	37
1 1/4"	H-86355W	4/16	16
1 1/2"	H-86356W	2/8	11
2"	H-86357W	2/8	24
Press × Press × F1807 PEX		250 PSI CWP Max/250°F Max	
1/2"	H-86152W	25/100	17
3/4"	H-86153W	20/80	25
3/4" × 3/4" × 1/2"	H-86153W-R	20/80	21
1"	H-86154W	20/80	40
1" × 1" × 3/4"	H-86154W-R	20/80	35
1 1/4"	H-86155W	4/16	15
3/4" × 3/4" × 1/2"	H-86153W-R	20/80	21
1" × 1" × 3/4"	H-86154W-R	20/80	35

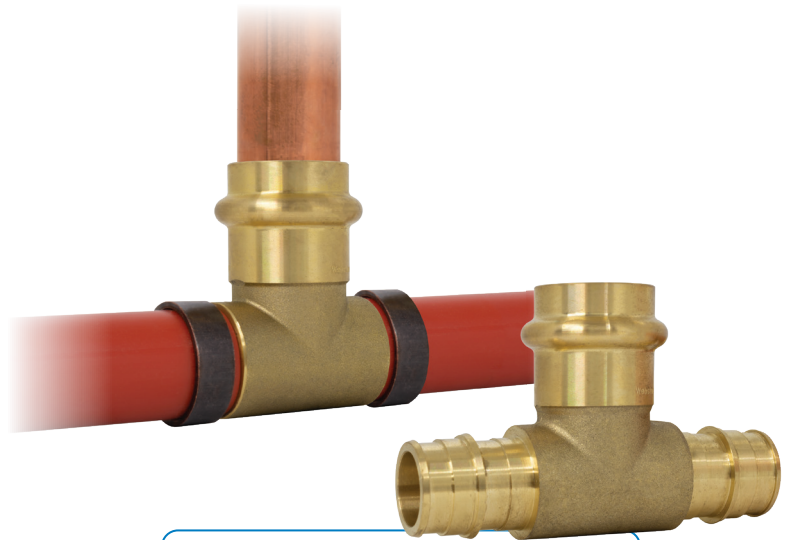

FORGED DZR BRASS TRANSITION TEE

LEAD-FREE BRASS			
SIZE	ITEM#	CTN/CASE	CASE WT
H-x685 Series			
F1960 PEX × F1960 PEX × Press		250 PSI CWP Max/250°F Max	
1/2"	H-36852W	25/100	21
1/2" × 1/2" × 3/4"	H-36852W-BH	20/80	21
3/4"	H-36853W	20/80	29
3/4" × 3/4" × 1"	H-36853W-BH	16/64	29
1"	H-36854W	20/80	49
1 1/4"	H-36855W	6/24	28
1 1/2"	H-36856W	2/8	12
2"	H-36857W	2/8	29
F1807 PEX × F1807 PEX × Press		250 PSI CWP Max/250°F Max	
1/2"	H-16852W	25/100	18
1/2" × 1/2" × 3/4"	H-16852W-BH	20/80	20
3/4"	H-16853W	20/80	26
3/4" × 3/4" × 1"	H-16853W-BH	16/64	27
1"	H-16854W	20/80	42
1 1/4"	H-16855W	6/24	21

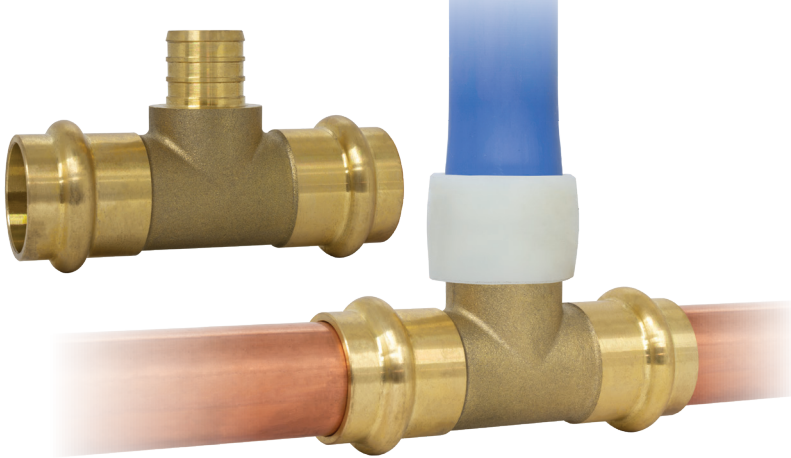

PRESS × PRESS × FIP TRANSITION TEE

- Ideal for branch or device connections in tight locations

FORGED DZR BRASS TRANSITION TEE

LEAD-FREE BRASS			
SIZE	ITEM#	CTN/CASE	CASE WT
H-86x5 Series			
Press × Press × FIP		250 PSI CWP Max/250°F Max	
1/2"	H-86452W	10/80	19
1/2" × 1/2" × 1/4"	H-86452W-R	25/100	17
3/4"	H-86453W	10/80	33
3/4" × 3/4" × 1/4"	H-86453W-R14	20/80	20
3/4" × 3/4" × 1/2"	H-86453W-R	20/80	27
1" × 1" × 1/2"	H-86454W-R12	20/80	38

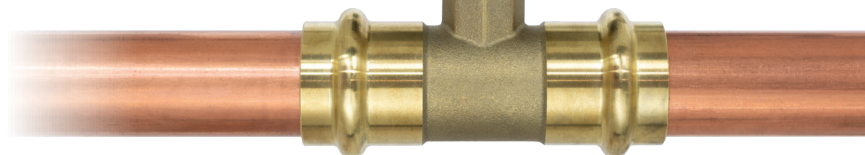
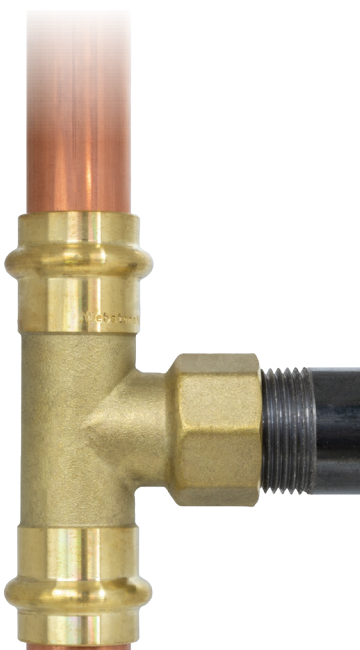



MULTI-PORT TRANSITION TEES

PATENTED TECHNOLOGY

- Eliminates installing gangs of tees
- Conveniently drain a system run and branches, or terminate the line
- Compact design is suitable for a variety of water distribution needs
- Durable heavy-duty forged DZR brass construction
- Press run with your choice of PEX connections

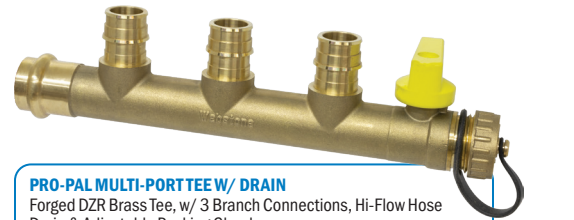

PRO-PAL MULTI-PORT TEE W/ DRAIN

Forged DZR Brass Tee, w/ 3 Branch Connections, Hi-Flow Hose Drain & Adjustable Packing Gland

SIZE	ITEM#	LEAD-FREE BRASS	
		CTN/CASE	CASE WT
H-86x7 Series			
Press Run × F1960 PEX		250 PSI CWP/250°F Max	
3/4"	H-86373W	4/24	28
3/4" × 1/2"	H-86373W-R	4/24	28
1" × 3/4"	H-86374W-R	4/24	33
Press Run × F1807 PEX			
3/4"	H-86173W	4/24	27
3/4" × 1/2"	H-86173W-R	4/24	31
1" × 3/4"	H-86174W-R	4/24	31

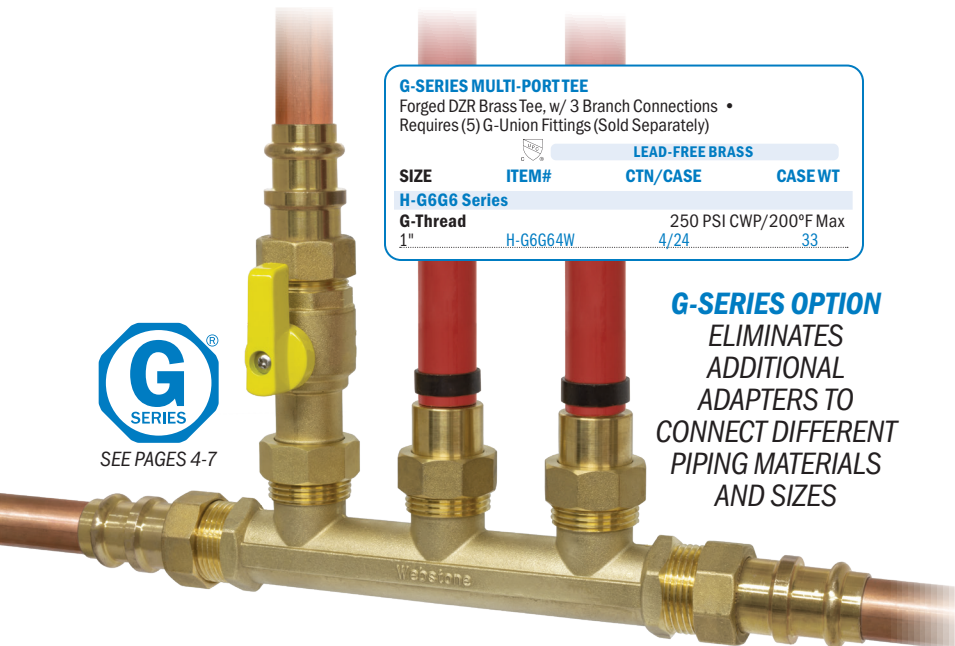

G-SERIES MULTI-PORT TEE
Forged DZR Brass Tee, w/ 3 Branch Connections • Requires (5) G-Union Fittings (Sold Separately)

SIZE	ITEM#	LEAD-FREE BRASS	
		CTN/CASE	CASE WT
H-G666 Series			
G-Thread		250 PSI CWP/200°F Max	
1"	H-G6664W	4/24	33

G-SERIES OPTION
ELIMINATES
ADDITIONAL
ADAPTERS TO
CONNECT DIFFERENT
PIPING MATERIALS
AND SIZES



PRO-PAL MULTI-PORT TEE

Forged DZR Brass Tee, w/ 3 Branch Connections & Press Port Plug

SIZE	ITEM#	LEAD-FREE BRASS	
		CTN/CASE	CASE WT
H-86x6 Series			
Press Run × F1960 PEX		250 PSI CWP/250°F Max	
3/4"	H-86363W	4/24	23
3/4" × 1/2"	H-86363W-R	4/24	23
1" × 3/4"	H-86364W-R	4/24	28
Press Run × F1807 PEX			
3/4"	H-86163W	4/24	21
3/4" × 1/2"	H-86163W-R	4/24	22
1" × 3/4"	H-86164W-R	4/24	26



SEE PAGES 4-7

G-SERIES END CAP
TERMINATES RUN OR
RESERVES PORTS FOR
FUTURE NEEDS



G-SERIES END CAP
Forged DZR Brass

SIZE	ITEM#	LEAD-FREE BRASS	
		CTN/CASE	CASE WT
H-7-x60 Series			
G-Thread		200 PSI CWP Max/200°F Max	
1"	H-7-B604W	15/150	19
1 1/2"	H-7-B606W	10/100	26
2"	H-7-B607W	8/80	28

PRESS PORT PLUG
QUICKLY TERMINATES
A PRESS END



PRESS PORT PLUG

SIZE	ITEM#	LEAD-FREE BRASS	
		CTN/CASE	CASE WT
H-x660 Series			
FTG		250 PSI CWP/250°F Max	
3/4"	H-86603W	1/120	13
1"	H-86604W	1/120	13

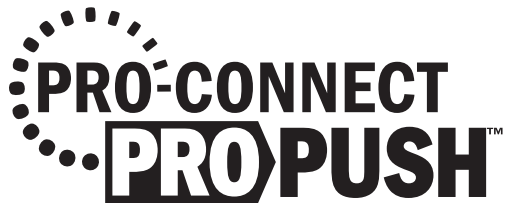

PRO PERFORMANCE PUSH CONVENIENCE

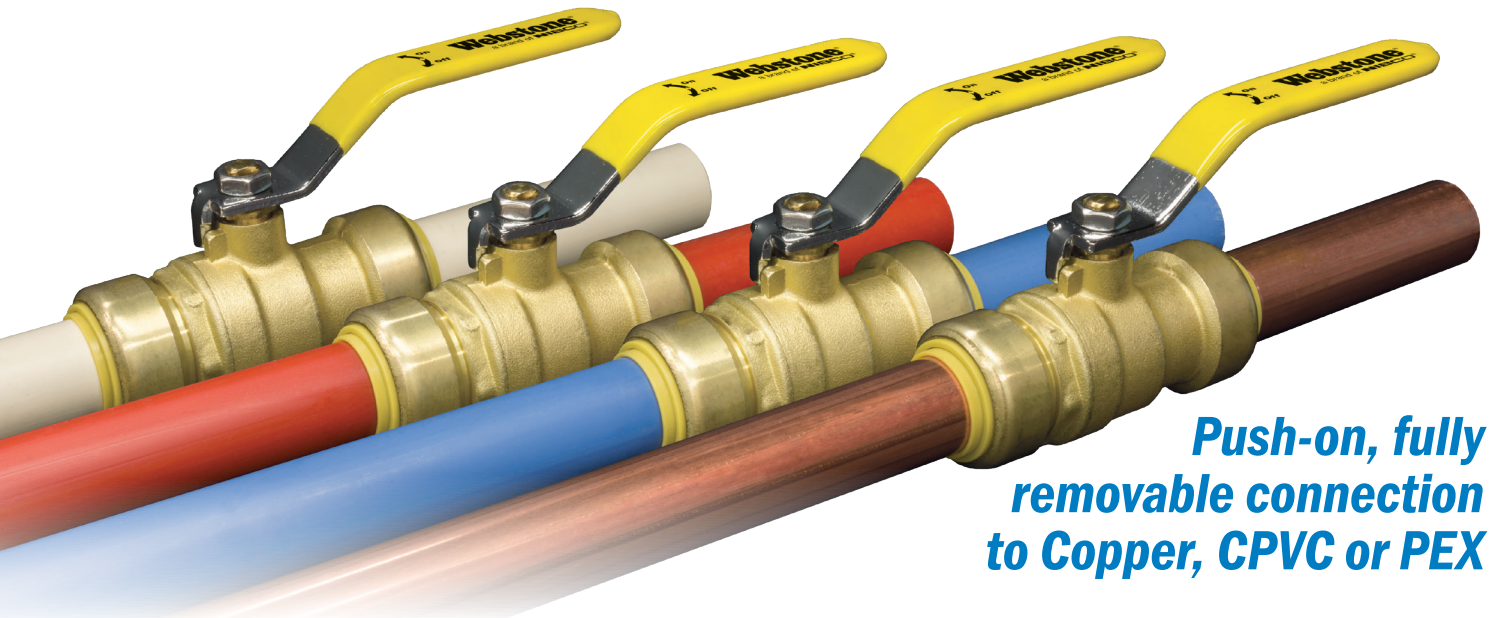

Push-on, fully removable connection to Copper, CPVC or PEX



PRO-PUSH BALL VALVE

Full Port Forged DZR Brass w/ Adjustable Packing Gland • For Connection to Copper, CPVC, or PEX

SIZE	ITEM#	LEAD-FREE BRASS	
		CTN/CASE	CASE WT
H-6270 Series			
Push		200 PSI CWP Max/200°F Max	
1/2"	H-62702W	10/100	46
3/4"	H-62703W	10/100	65
1"	H-62704W	5/50	60



PRO-PUSH 90 DEGREE ELBOW

Forged DZR Brass Fitting • For Connection to Copper, CPVC or PEX

SIZE	ITEM#	LEAD-FREE BRASS	
		CTN/CASE	CASE WT
H-2640 Series			
Push		200 PSI CWP Max/200°F Max	
1/2"	H-26402W	20/200	32
1/2"×3/8"	H-26421W-B	1/180	27
3/4"	H-26403W	12/120	33
3/4"×1/2"	H-26432W	12/120	27
1"	H-26404W	10/100	49
1"×3/4"	H-26443W-B	1/60	24
Push × FIP			
1/2"	H-26422W	20/200	37
Push × MIP			
1/2"	H-26222W	20/200	37
3/4"	H-26233W-B	1/90	27



PRO-PUSH STRAIGHT COUPLING

Forged DZR Brass Fitting • For Connection to Copper, CPVC or PEX

SIZE	ITEM#	LEAD-FREE BRASS	
		CTN/CASE	CASE WT
H-2610 Series			
Push		200 PSI CWP Max/200°F Max	
1/2"	H-26102W	25/250	33
3/4"	H-26103W	10/100	19
3/4"×1/2"	H-26132W	15/150	27
1"×3/4"	H-26143W	9/90	25
1"	H-26104W	9/90	29
Push × FIP			
1/2"	H-26202W	20/200	27
1/2"×3/4"	H-26223W	20/200	34
3/4"	H-26203W	12/120	24
3/4"×1/2"	H-26232W-B	1/180	24
3/4"×1"	H-26234W-B	1/90	22
1"	H-26204W	9/90	26
Push × MIP			
1/2"	H-26302W	20/200	24
1/2"×3/4"	H-26323W	20/200	34
3/4"	H-26303W	15/150	29
3/4"×1/2"	H-26332W-B	1/150	21
3/4"×1"	H-26334W-B	1/90	24
1"×3/4"	H-26343W	9/90	21
1"	H-26304W	9/90	24



PRO-PUSH TEE

Forged DZR Brass Fitting • For Connection to Copper, CPVC or PEX

SIZE	ITEM#	LEAD-FREE BRASS	
		CTN/CASE	CASE WT
H-2650 Series			
Push × Push × Push		200 PSI CWP Max/200°F Max	
1/2"	H-26502W	12/120	24
3/4"	H-26503W	12/120	44
3/4"×1/2"×1/2"	H-26522W	18/180	44
3/4"×3/4"×1/2"	H-26532W	15/150	49
3/4"×1/2"×3/4"	H-26533W	12/120	42
1"×1"×3/4"	H-26543W	6/60	32
1"	H-26504W	6/60	39



PROPUSH FLEXIBLE WATER HEATER CONNECTOR

Braided Stainless Steel • For Connection to Copper, CPVC or PEX

LEAD-FREE BRASS				
SIZE	LENGTH	ITEM#	CTN/CASE	CASE WT
H-2603 Series				
Push × FIP 200 PSI CWP Max/200°F Max				
1/2" × 3/4"	12"	H-26023W-12-B	12/60	27
3/4"	12"	H-26033W-12	1/50	31
1/2" × 3/4"	15"	H-26023W-15-B	12/60	27
3/4"	15"	H-26033W-15	12/48	33
1/2" × 3/4"	18"	H-26023W-18	1/50	23
3/4"	18"	H-26033W-18	1/50	43
1/2" × 3/4"	24"	H-26023W-24-B	12/60	27
3/4"	24"	H-26033W-24	1/50	49
H-6202 Series				
w/ Full Port Forged DZR Brass Ball Valve				
1/2" × 3/4"	18"	H-62023W-18	1/25	21
3/4"	18"	H-62033W-18	1/25	34

WEBSTONE EXCLUSIVES AVAILABLE W/PUSH CONNECTIONS

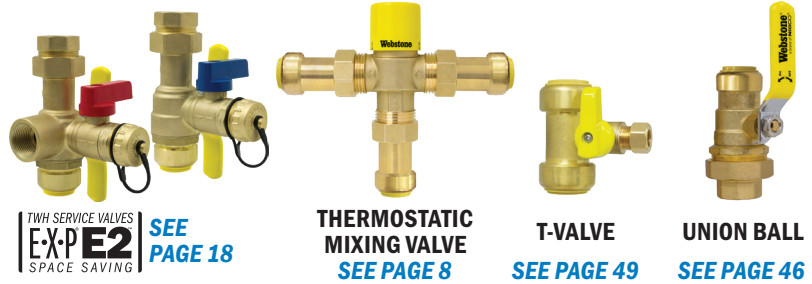

TWH SERVICE VALVES
EXP E2
SPACE SAVING SEE PAGE 18

THERMOSTATIC MIXING VALVE
SEE PAGE 8

T-VALVE
SEE PAGE 49

UNION BALL
SEE PAGE 46



PROPUSH IN-LINE SPRING CHECK VALVE

Forged DZR Brass Fitting • For Connection to Copper, CPVC or PEX

LEAD-FREE BRASS			
SIZE	ITEM#	CTN/CASE	CASE WT
H-2699 Series			
Push 200 PSI CWP Max/200°F Max			
1/2"	H-26992W-B	6/120	20
3/4"	H-26993W	12/120	39
1"	H-26994W-B	3/45	25



PROPUSH 90 DEGREE DROP EAR ELBOW

Forged DZR Brass Fitting • For Connection to Copper, CPVC or PEX

LEAD-FREE BRASS			
SIZE	ITEM#	CTN/CASE	CASE WT
H-2640 Series			
Push × FIP 200 PSI CWP Max/200°F Max			
1/2"	H-26412W	9/90	21



PROPUSH 1/4 TURN SUPPLY STOP

Chrome-Plated DZR Brass • For Connection to Copper, CPVC or PEX

LEAD-FREE BRASS			
SIZE	ITEM#	CTN/CASE	CASE WT
H-26x2 Series			
Angled			
Push × Compression			
1/2" × 1/4"	H-26820W	20/200	54
1/2" × 3/8"	H-26821W	20/200	55
Straight			
Push × Compression			
1/2" × 1/4"	H-26920W	20/200	51
1/2" × 3/8"	H-26921W	20/200	52



PROPUSH 90 DEGREE HY-EAR ELBOW

Forged DZR Brass Fitting • For Connection to Copper, CPVC or PEX

LEAD-FREE BRASS			
SIZE	ITEM#	CTN/CASE	CASE WT
H-2640 Series			
Push × FIP 200 PSI CWP Max/200°F Max			
1/2"	H-26412WHE-B	6/120	32



PROPUSH SLIP COUPLING

Forged DZR Brass Fitting • For Connection to Copper, CPVC or PEX

LEAD-FREE BRASS			
SIZE	ITEM#	CTN/CASE	CASE WT
H-2670 Series			
Push 200 PSI CWP Max/200°F Max			
1/2"	H-26122W	15/150	36
3/4"	H-26133W	5/50	20
1"	H-26144W	5/50	25

PROPUSH REPAIR TEE

Forged DZR Brass Fitting • For Connection to Copper, CPVC or PEX

LEAD-FREE BRASS			
SIZE	ITEM#	CTN/CASE	CASE WT
H-2670 Series			
Push 200 PSI CWP Max/200°F Max			
1/2"	H-26702W	8/80	26
3/4"	H-26703W	6/60	34



PROPUSH REMOVAL TOOL

SIZE	ITEM#	CTN/CASE	CASE WT
H-2811 Series			
1/4"	H-28110-B	24/1200	25
3/8"	H-28111-B	24/1200	25
1/2"	H-28112	1/300	3
3/4"	H-28113	1/300	6
1"	H-28114	1/250	7
1 1/4"	H-28115-B	1/50	26
1 1/2"	H-28116-B	1/50	16
2"	H-28117-B	1/50	21

PROPUSH END CAP

Forged DZR Brass Fitting • For Connection to Copper, CPVC or PEX

LEAD-FREE BRASS			
SIZE	ITEM#	CTN/CASE	CASE WT
H-2660 Series			
Push 200 PSI CWP Max/200°F Max			
1/2"	H-26602W	30/300	22
3/4"	H-26603W	20/200	26
1"	H-26604W	12/120	25

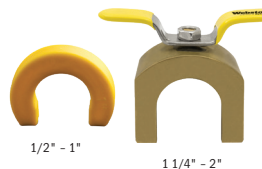

PROPUSH DEBURR & GAUGETOOL

SIZE	ITEM#	BAG/CASE	CASE WT
H-2800 Series			
1/4" - 1"	H-28000-B	1/50	7



PROPUSH PEX ADAPTER SET

SIZE	ITEM#	CTN/CASE	CASE WT
H-2821 Series			
1/2"	H-28212	1/300	2
3/4"	H-28213	1/300	1
1"	H-28214	1/250	2
1 1/4"	H-28215-B	1/100	5
1 1/2"	H-28216-B	1/100	8
2"	H-28217-B	1/100	13

PRO-CONNECT PP-R PRO™

INNOVATIVE VALVES FOR ANY PP-R PIPE

PATENTED TECHNOLOGY

- Permanent leak-free heat fused connections made in seconds
- PP-RCT sockets compatible with all PP-R & PP-RCT piping systems†
- Safe, clean, long-lasting, high performance materials
- Suitable for potable applications
- Available in female metric socket nominal sizes 1/2" to 2"
- G-Series PP-RCT union fittings add PP-R-CT connections to any Webstone G-Series body
- Saves labor, space & leak paths



SEE PAGES 4-7



FULL PORT FORGED BRASS BALL VALVE
w/ Adjustable Packing Gland • Compatible with PP-R & PP-RCT Piping Systems

SIZE	LEAD-FREE BRASS			
	SOCKET I.D.	ITEM#	CTN/CASE	CASE WT
H-1014x Series				
Female PP-RCT Metric Socket				
3/4"	25 mm	H-101403WHV	1/20	600 PSI*
1"	32 mm	H-101404WHV	1/10	32
1 1/4"	40 mm	H-101405WHV	1/20	43
1 1/2"	50 mm	H-101406WHV	1/10	58
2"	63 mm	H-101407WHV	1/20	38
				45

FULL PORT FORGED BRASS BALL VALVE
w/ Adjustable Packing Gland • Compatible with PP-R & PP-RCT Piping Systems

SIZE	LEAD-FREE BRASS			
	SOCKET I.D.	ITEM#	CTN/CASE	CASE WT
H-10x70 Series				
Female PP-RCT Metric Socket				
1/2"	20 mm	H-101702W	5/50	600 PSI*
3/4"	25 mm	H-101703W	5/40	30
1"	32 mm	H-101704W	4/20	35
1 1/4"	40 mm	H-101705W	5/20	33
1 1/2"	50 mm	H-101706W	4/16	43
2"	63 mm	H-101707W	2/8	55
				42
Female PP-RCT Metric Socket x FIP				
1/2"	20 mm	H-104702W	5/50	600 PSI*
3/4"	25 mm	H-104703W	5/40	28
1"	32 mm	H-104704W	4/20	33
1 1/4"	40 mm	H-104705W	5/20	29
1 1/2"	50 mm	H-104706W	4/16	42
2"	63 mm	H-104707W	2/8	50
				35



ADD PP-RCT CONNECTIONS TO ANY WEBSTONE G-SERIES BODY

SEE PAGES 4-7



IDEAL FOR USE WITH G-SERIES BALL DRAIN - SEE PAGE 4



G-SERIES UNION FITTING
Forged DZR Brass w/ Overmolded PP-RCT Tailpiece • Compatible with PP-R & PP-RCT Piping Systems

SIZE	LEAD-FREE BRASS			
	SOCKET I.D.	ITEM#	CTN/CASE	CASE WT
H-7-910 Series				
G-Union x Female PP-RCT Metric Socket			200 PSI CWP Max/200°F Max	
1" x 1/2"	20 mm	H-7-9102W	10/100	29
1" x 3/4"	25 mm	H-7-9103W	10/100	35
1" x 1"	32 mm	H-7-9104W	6/60	33
1 1/2" x 1 1/4"	40 mm	H-7-9165W	4/40	35
1 1/2" x 1 1/2"	50 mm	H-7-9166W	4/32	34
2" x 2"	63 mm	H-7-9177W	4/16	26

STEM EXTENSION KIT

- Replaces existing handle
- Accommodates up to 2" of insulation
- Improves handle accessibility

STEM EXTENSION

VALVE SIZE	ITEM#	CTN/CASE	CASE WT
H-SE917 Series			
Fits H-10x70 & H-1014x Series			
1"	H-SE-91704	10/40	27
1 1/4"	H-SE-91705	8/32	24
1 1/2"	H-SE-91706	6/24	28
2"	H-SE-91707	6/24	28

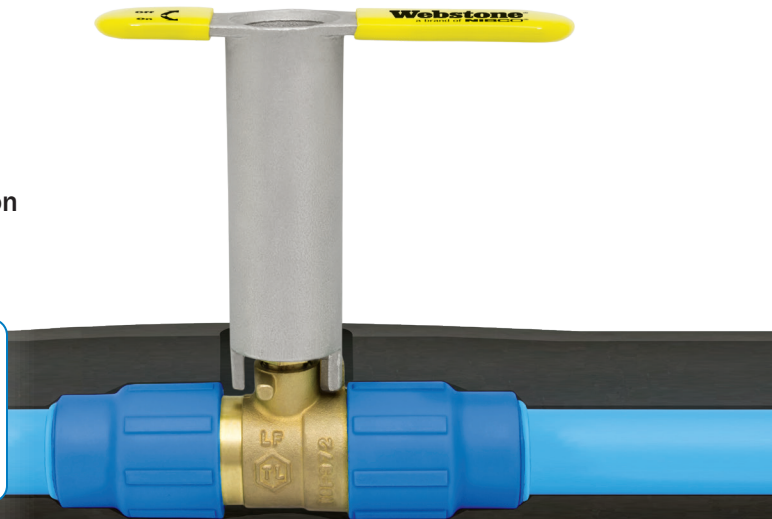

*Valve seat/body maximum pressure rating at 100° F. Overall valve pressure rating is determined by intended operating conditions and limitations specific to the system design.

BALL VALVES



FULL PORT FORGED BRASS BALL VALVE w/ Adjustable Packing Gland

SIZE	ITEM#	CTN/CASE	CASE WT
H-x170 Series			
FIP 600 PSI CWP Max/200°F Max			
1/2"	H-40702	18/72	34
3/4"	H-40703	12/48	34
1"	H-40704	6/24	28
1 1/4"	H-40705	4/16	27
1 1/2"	H-40706	2/8	21
2"	H-40707	2/8	29



SIZE	ITEM#	CTN/CASE	CASE WT
SWT 600 PSI CWP Max/200°F Max			
1/2"	H-50702	18/72	31
3/4"	H-50703	12/48	32
1"	H-50704	6/36	42
1 1/4"	H-50705	4/24	36
1 1/2"	H-50706	2/16	34
2"	H-50707	2/12	44

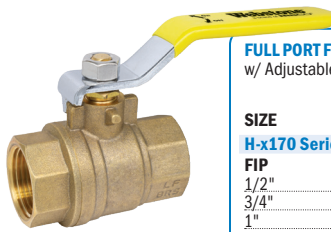

FULL PORT FORGED DZR BRASS BALL VALVE w/ Adjustable Packing Gland

SIZE	ITEM#	CTN/CASE	CASE WT
H-x170 Series			
FIP 600 PSI CWP Max/200°F Max			
1/2"	H-40702W	18/72	34
3/4"	H-40703W	12/48	34
1"	H-40704W	6/24	28
1 1/4"	H-40705W	4/16	31
1 1/2"	H-40706W	2/8	22
2"	H-40707W	2/8	30

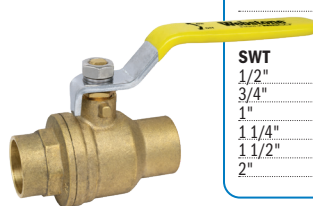

SIZE	ITEM#	CTN/CASE	CASE WT
SWT 600 PSI CWP Max/200°F Max			
1/2"	H-50702W	18/72	31
3/4"	H-50703W	12/48	32
1"	H-50704W	6/36	44
1 1/4"	H-50705W	4/24	35
1 1/2"	H-50706W	2/16	38
2"	H-50707W	2/12	47



2 1/2" - 4" SIZES
FEATURE PRESS XLC
CONNECTIONS

FULL PORT FORGED BRASS BALL VALVE w/ Adjustable Packing Gland

SIZE	ITEM#	CTN/CASE	CASE WT
H-x170 Series			
Press 250 PSI CWP Max/250°F Max			
1/2"	H-81702W	5/50	27
3/4"	H-81703W	5/40	33
1"	H-81704W	4/20	26
1 1/4"	H-81705W	5/20	38
1 1/2"	H-81706W	4/16	43
2"	H-81707W	2/8	34
2 1/2"	H-81708W	1/1	8
3"	H-81709W	1/1	12
4"	H-81710W	1/1	21



FULL FLOW FORGED DZR BRASS BALL VALVE w/ Stainless Steel Wing Style "T" Handle & Adjustable Packing Gland

SIZE	ITEM#	CTN/CASE	CASE WT
H-x170 Series			
F1960 PEX 400 PSI CWP Max/250°F Max			
1/2"	H-31702WSSW	10/80	28
3/4"	H-31703WSSW	10/60	29
1"	H-31704WSSW	6/36	31
1 1/4"	H-31705WSSW	5/25	32
1 1/2"	H-31706WSSW	5/25	46
2"	H-31707WSSW	2/12	38
F1807 PEX			
1/2"	H-11702WSSW	10/80	27
3/4"	H-11703WSSW	10/60	21
1"	H-11704WSSW	6/36	30

FULL PORT FORGED DZR BRASS BALL VALVE w/ Stainless Steel Wing Handle & Adjustable Packing Gland

SIZE	ITEM#	CTN/CASE	CASE WT
H-x170 Series			
FIP 600 PSI CWP Max/200°F Max			
1/2"	H-40702WSSW	18/72	38
3/4"	H-40703WSSW	12/48	37
1"	H-40704WSSW	6/24	29



PROPUSH BALL VALVE

Full Port Forged DZR Brass w/ Adjustable Packing Gland • For Connection to Copper, CPVC, or PEX

SIZE	ITEM#	CTN/CASE	CASE WT
H-6270 Series			
Push 200 PSI CWP Max/200°F Max			
1/2"	H-62702W	10/100	46
3/4"	H-62703W	10/100	65
1"	H-62704W	5/50	60



FORGED BRASS BALL VALVE & Adjustable Packing Gland

SIZE	ITEM#	CTN/CASE	CASE WT
H-x170 Series			
Compression 600 PSI CWP Max/150 WSP			
1/2"	H-40632W	25/100	60
3/4"	H-40633W	15/60	55
1"	H-40634W	10/40	56





SAVE SPACE IN THE FIELD AND IN THE TRUCK

- Create over 250 different combinations from a single G-Series ball valve body
- Connect different piping types and sizes, right at the valve, without the need for additional adapters

G-SERIES BALL VALVE

Full Flow Forged DZR Brass Ball Valve w/ Adjustable Packing Gland

SIZE	ITEM#	CTN/CASE	CASE WT
LEAD-FREE BRASS			
H-G170 Series			
Body Only - Install w/ (2) G-Union Fittings			
G-Thread		200 PSI CWP Max/200°F Max	
1"	H-G1704W	1/16	19
1 1/2"	H-G1706W	1/8	23
1 1/2" x 1"	H-G1706W-R	1/12	15
2"	H-G1707W	1/6	26
2" x 1 1/2"	H-G1707W-R	1/6	18



SEE PAGES 4-7

G-SERIES BALL VALVE

Full Flow Forged DZR Brass Ball Valve w/ Reversible Handle & Adjustable Packing Gland

SIZE	ITEM#	CTN/CASE	CASE WT
LEAD-FREE BRASS			
H-G-x170 Series			
Body Only - Install w/ (1) G-Union Fitting			
G-Thread x Press		200 PSI CWP Max/200°F Max	
1"	H-G-81704W	1/16	28
1" x 1/2"	H-G-81704W-R12	1/16	18
1" x 3/4"	H-G-81704W-R	1/16	22
1 1/2"	H-G-81706W	1/8	29
1 1/2" x 1 1/4"	H-G-81706W-R	1/8	25
2"	H-G-81707W	1/4	23
2" x 1 1/2"	H-G-81707W-R	1/8	32



FULL PORT FORGED DZR BRASS BALL VALVE

w/ Adjustable Packing Gland

SIZE	ITEM#	CTN/CASE	CASE WT
LEAD-FREE BRASS			
H-80x3 Series			
Press x F1960 PEX		250 PSI CWP Max/250°F Max	
1/2"	H-80332W	5/50	26
3/4"	H-80333W	5/40	21
1"	H-80334W	4/20	11
1 1/4"	H-80335W	5/20	46
1 1/2"	H-80336W	4/16	44
2"	H-80337W	2/8	40
Press x F1807 PEX			
1/2"	H-80132W	5/50	26
3/4"	H-80133W	5/40	21
1"	H-80134W	4/20	11
1 1/4"	H-80135W	5/20	44
1 1/2"	H-80136W	4/16	42
2"	H-80137W	2/8	36



FULL PORT FORGED DZR BRASS BALL VALVE

w/ Reversible Handle & Adjustable Packing Gland

SIZE	ITEM#	CTN/CASE	CASE WT
LEAD-FREE BRASS			
H-8x70 Series			
Press x FIP		250 PSI CWP Max/250°F Max	
1/2"	H-84702W	5/50	26
3/4"	H-84703W	5/40	31
1"	H-84704W	4/24	30
1 1/4"	H-84705W	5/20	41
1 1/2"	H-84706W	4/16	39
2"	H-84707W	2/8	32
Press x MIP			
1/2"	H-82702W	5/50	27
3/4"	H-82703W	5/40	34
1"	H-82704W	4/24	33
1 1/4"	H-82705W	5/20	44
1 1/2"	H-82706W	4/16	41
2"	H-82707W	2/8	35



FULL FLOW FORGED DZR BRASS BALL VALVE

w/ Stainless Steel Wing Style "T" Handle & Adjustable Packing Gland

SIZE	ITEM#	CTN/CASE	CASE WT
LEAD-FREE BRASS			
H-x170 Series			
F1960 PEX x FIP		400 PSI CWP Max/250°F Max	
1/2"	H-34702WSSW	10/80	28
3/4"	H-34703WSSW	10/60	30
1"	H-34704WSSW	6/36	32
F1807 PEX x FIP			
1/2"	H-14702WSSW	10/80	28
3/4"	H-14703WSSW	10/60	21
1"	H-14704WSSW	6/36	30



FULL PORT FORGED BRASS BALL VALVE

w/ Reversible Handle & Adjustable Packing Gland

SIZE	ITEM#	CTN/CASE	CASE WT
LEAD-FREE BRASS			
H-x053 Series			
MIP x FIP		600 PSI CWP Max/150 WSP	
1/4"	H-40530W	12/96	36
3/8"	H-40531W	12/96	34
1/2"	H-40532W	12/96	47
3/4"	H-40533W	10/60	47
1"	H-40534W	6/48	60

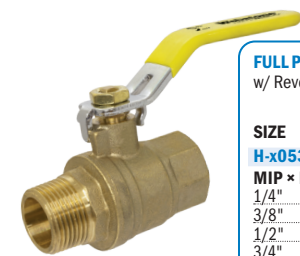

FULL FLOW FORGED BRASS BALL VALVE

w/ Wing Handle

SIZE	ITEM#	CTN/CASE	CASE WT
STANDARD BRASS			
H-x068 Series			
F1807 PEX x SWT		160 PSI CWP Max	
1/2"	H-50682	10/100	27



FULL PORT FORGED BRASS BALL VALVE

Pet Cock Style

SIZE	ITEM#	CTN/CASE	CASE WT
STANDARD BRASS			
H-x168 Series			
FIP x MIP		600 PSI CWP Max/125 WSP	
1/8"	H-41685	10/100	19
1/4" x 1/8"	H-41686	10/100	18
1/4"	H-41687	10/100	18
FIP			
1/8"	H-41698	10/100	19
1/4"	H-41699	10/100	17

SPECIALTY VALVES



FORGED BRASS GAS BALL VALVE

SIZE	STANDARD BRASS		
	ITEM#	CTN/CASE	CASE WT
H-2256 Series			
FIP		UPTO 5 PSI CWP Max	
3/8"	H-22561	12/144	34
1/2"	H-22562	12/144	52
3/4"	H-22563	12/144	76
1"	H-22564	6/72	64

FULL PORT FORGED DZR BRASS BALL VALVE

w/ Bleeder, Reversible Handle & Adjustable Packing Gland

SIZE	LEAD-FREE BRASS		
	ITEM#	CTN/CASE	CASE WT
H-x062 Series			
FIP		600 PSI CWP Max/150 WSP/250°F Max	
1/2"	H-40622W	15/120	63
3/4"	H-40623W	12/48	39
1"	H-40624W	8/32	41
SWT			
1/2"	H-50622W	25/100	53
3/4"	H-50623W	10/40	33
1"	H-50624W	6/24	31
LEAD-FREE BRASS			
Press		250 PSI CWP Max/250°F Max	
1/2"	H-80622W	4/40	24
3/4"	H-80623W	4/32	29
1"	H-80624W	3/15	21



FULL PORT FORGED BRASS BALL VALVE

w/ 1/4" Threaded Gauge Hole (Plugged), Reversible Handle & Adjustable Packing Gland

SIZE	STANDARD BRASS		
	ITEM#	CTN/CASE	CASE WT
H-x172 Series			
FIP		600 PSI CWP Max/150 WSP	
1/2"	H-41722	10/80	44
3/4"	H-41723	10/60	48
1"	H-41724	6/48	59
1 1/4"	H-41725	4/32	59
1 1/2"	H-41726	2/24	68
2"	H-41727	2/16	64



FULL PORT FORGED BRASS BALL VALVE

3 Way L-Port w/ Reversible Handle & Adjustable Packing Gland

SIZE	STANDARD BRASS		
	ITEM#	CTN/CASE	CASE WT
H-4064 Series			
FIP		600 PSI CWP Max/150 WSP	
1/2"	H-40642	15/60	35
3/4"	H-40643	10/40	36
1"	H-40644	6/24	36



CHROME-PLATED EXTRUDED BRASS MINI BALL VALVE

Hex Body

SIZE	STANDARD BRASS		
	ITEM#	CTN/CASE	CASE WT
H-x078 Series			
F1807 PEX		110 PSI CWP Max NON-SHOCK	
1/2"	H-40782	30/300	62

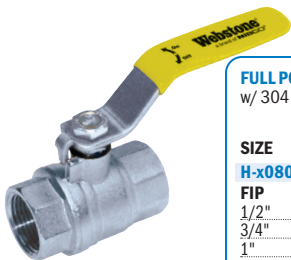

FULL PORT NICKEL-PLATED FORGED BRASS BALL VALVE

w/ 304 Stainless Steel Lever Handle & Adjustable Packing Gland

SIZE	LEAD-FREE BRASS		
	ITEM#	CTN/CASE	CASE WT
H-x080 Series			
FIP		600 PSI CWP Max/150 WSP	
1/2"	H-40802W	20/120	56
3/4"	H-40803W	14/84	61
1"	H-40804W	8/48	56
1 1/4"	H-40805W	6/36	60
1 1/2"	H-40806W	4/24	64
2"	H-40807W	2/16	57



FULL PORT 316 STAINLESS STEEL BALL VALVE

2-Piece Investment Cast w/ 304 Stainless Steel Locking Handle & Adjustable Packing Gland

SIZE	STANDARD BRASS		
	ITEM#	CTN/CASE	CASE WT
H-x372 Series			
FIP		1000 PSI CWP Max/150 WSP	
1/4"	H-43720	2/80	43
3/8"	H-43721	2/80	39
1/2"	H-43722	2/60	45
3/4"	H-43723	2/40	45
1"	H-43724	2/40	68
1 1/4"	H-43725	2/30	80
1 1/2"	H-43726	2/16	64
2"	H-43727	2/10	52
H-x372 Series			
w/ 304 Stainless Steel Oval Handle			
FIP		1000 PSI CWP Max/150 WSP	
1/2"	H-43722-0H	1/40	35
3/4"	H-43723-0H	1/30	37
1"	H-43724-0H	1/20	37



FORGED BRASS GATE VALVE

Hard Seat

SIZE	LEAD-FREE BRASS		
	ITEM#	CTN/CASE	CASE WT
H-1013 Series			
FIP		200 PSI CWP Max/125 WSP	
1/2"	H-10132W	10/100	53
3/4"	H-10133W	10/100	72
1"	H-10134W	5/50	48
1 1/4"	H-10135W	5/30	52
1 1/2"	H-10136W	2/30	65
2"	H-10137W	2/20	59

ITEM #	PAGE	ITEM #	PAGE	ITEM #	PAGE	ITEM #	PAGE
H-4CC4-NBHK	26	H-7-8204W WP	10	H-86x7 Series	57	H-10615W	44
H-4CCL54-54Y	26	H-7-9102W	5, 61	H-107x Series	53	H-10616W	44
H-4FK4-WIF	26	H-7-9103W	5, 61	H-108G4W	5, 6, 7, 52	H-10617W	44
H-5CC4-NBHK	26	H-7-9104W	5, 61	H-108G6W	6, 7, 52	H-10622W	52
H-5CCL54-54Y	26	H-7-9165W	5, 61	H-108G Series	6, 52	H-10623W	52
H-5FK4-WIF	26	H-7-9166W	5, 61	H-108x Series	52	H-10624W	52
H-7-7x20-C7 Series	11	H-7-9177W	5, 61	H-806x Series	44	H-10625W	52
H-7-710 Series	6	H-7-A104W	5	H-1013 Series	64	H-10626W	52
H-7-910 Series	5, 61	H-7-A104W-R	5	H-1014x Series	61	H-10627W	52
H-7-1102W	5	H-7-A104W-R12	5	H-1054 Series	52	H-10671W-T12	49
H-7-1103W	5	H-7-A106W	5	H-01102W	17	H-10671W-T34	49
H-7-1104W	5	H-7-A106W-R	5	H-01103W	17	H-10712W	53
H-7-1202W WP	10	H-7-A107W	5	H-01104W	17	H-10713W	53
H-7-1203W WP	10	H-7-A107W-R	5	H-01105W	17	H-10714W	53
H-7-1204W WP	10	H-7-B604W	5, 6, 57	H-01106W	17	H-10715W	53
H-7-2102W	5	H-7-B606W	6, 57	H-01107W	17	H-10732W	53
H-7-2103W	5	H-7-B607W	6, 57	H-01132W	17	H-10733W	53
H-7-2104W	5	H-7G00 Series	30	H-1370 Series	43	H-10734W	53
H-7-2164W WP	5	H-7G004	7, 30	H-2071 Series	21	H-10735W	53
H-7-2165W WP	5	H-7G006	7, 30	H-2244x-24 Series	23	H-10741W	53
H-7-2166W WP	5	H-7G007	7, 30	H-2244x Series	23	H-10742W	53
H-7-2177W WP	5	H-7-G134WY	10	H-2256 Series	64	H-10743W	53
H-7-2202W WP	10	H-7-G134WY-A	10	H-2603 Series	59	H-10744W	53
H-7-2203W WP	10	H-7-G144-A Series	6	H-2610 Series	14, 58	H-10745W	53
H-7-2204W WP	10	H-7-G144W-A	6	H-2640 Series	58, 59	H-10746W	53
H-7-3102W	5	H-7-G170 Series	6	H-2650 Series	58	H-10747W	53
H-7-3103W	5	H-7-G234 Series	10	H-2660 Series	59	H-10751W	53
H-7-3104W	5	H-7-G234WB	10	H-2670 Series	59	H-10752W	53
H-7-3202W WP	10	H-7-G234WB-A	10	H-2699 Series	53, 59	H-10753W	53
H-7-3203W WP	10	H-7-G234WR	10	H-2800 Series	59	H-10754W	53
H-7-3204W WP	10	H-7-G234WR-A	10	H-2811 Series	59	H-10755W	53
H-7-4102W	5	H-7-G304W-60	7	H-2821 Series	59	H-10756W	53
H-7-4103W	5	H-7-G304W-140	7	H-3100-BTM Series	33	H-10757W	53
H-7-4104W	5	H-7-G306W-60	7	H-3200 Series	7	H-10782W	53
H-7-4164W WP	5	H-7-G306W-140	7	H-4064 Series	64	H-10783W	53
H-7-4165W WP	5	H-7G406	7, 28	H-6202 Series	59	H-10784W	53
H-7-4166W WP	5	H-7-G1704W	6	H-6270 Series	58, 62	H-10785W	53
H-7-4177W WP	5	H-7-G1706W	6	H-7000-CAN Series	9, 11	H-10786W	53
H-7-4202W WP	10	H-7-G1707W	6	H-7000 Series	9, 11	H-10787W	53
H-7-4203W WP	10	H-7x00-RVA Series	31	H-7000-Y Series	9, 10	H-10812W	52
H-7-4204W WP	10	H-7x00 Series	30	H-7006 Series	9, 11	H-10813W	52
H-7-5102W	5	H-7x00-V Series	31	H-7007 Series	9, 11	H-10814W	52
H-7-5103W	5	H-7-x10 Series	5	H-7007-Y Series	9, 10	H-10822W	52
H-7-5104W	5	H-7-x20 Series	10	H-7040 Series	28	H-10823W	52
H-7-5164W WP	5	H-7-x30 Series	7	H-7100-V Series	31	H-10824W	52
H-7-5165W WP	5	H-7x31 Series	13	H-8142 Series	43	H-10825W	52
H-7-5166W WP	5	H-7x32 Series	13	H-10132W	64	H-10826W	52
H-7-5177W WP	5	H-7x40 Series	28	H-10133W	64	H-10832W	52
H-7-5202W WP	10	H-7x50AB Series	29	H-10134W	64	H-10833W	52
H-7-5203W WP	10	H-7x50-A Series	29	H-10135W	64	H-10834W	52
H-7-5204W WP	10	H-7x50B Series	29	H-10136W	64	H-10842W	52
H-7-6102W	5	H-7x50 Series	29	H-10137W	64	H-10843W	52
H-7-6103W	5	H-7-x60 Series	6, 57	H-10422W	17, 46	H-10844W	52
H-7-6104W	5	H-7x60 Series	30	H-10423W	17, 46	H-10845W	52
H-7-6202W WP	10	H-7x61 Series	32	H-10423W-RB	21	H-10846W	52
H-7-6203W WP	10	H-7x70B Series	35	H-10424W	17, 46	H-10852W	52
H-7-7104W	6	H-7x70 Series	35	H-10432W	17, 45	H-10853W	52
H-7-7106W	6	H-7x70XLB Series	34	H-10433W	17, 45	H-10854W	52
H-7-7106W-R1	6	H-7x70XL Series	34	H-10434W	17, 45	H-10855W	52
H-7-7107W	6	H-7x71 Series	35	H-10435W	17, 45	H-10856W	52
H-7-7107W-R	6	H-8CC4-NBHK	26	H-10436W	17, 45	H-10882W	52
H-7-7211 Series	12	H-8CCL54-54Y	26	H-10437W	17, 45	H-10883W	52
H-7-7211W WP	12	H-8FK4-WIF	26	H-10540W	52	H-10884W	52
H-7-7610W-TG WP	12	H-8-G2443W	20, 21	H-10541W	52	H-10885W	52
H-7-7610W WP	12	H-8-G2443WPR	20, 21	H-10542W	52	H-10886W	52
H-7-8102W	5	H-8-G2443WPR-GST	22	H-10543W	52	H-11403W	40
H-7-8103W	5	H-8x70 Series	63	H-10544W	52	H-11403WHV	40
H-7-8104W	5	H-10x70 Series	61	H-10545W	52	H-11404W	40
H-7-8164W WP	5	H-26x2 Series	59	H-10546W	52	H-11404WHV	40
H-7-8165W WP	5	H-80x3 Series	63	H-10547W	52	H-11413W	40
H-7-8166W WP	5	H-86x0 Series	54	H-10549W	52	H-11413WHV	40
H-7-8177W WP	5	H-86x4 Series	55	H-10612W	44	H-11414W	40
H-7-8202W WP	10	H-86x5 Series	56	H-10613W	44	H-11414WHV	40
H-7-8203W WP	10	H-86x6 Series	57	H-10614W	44	H-11702WSSW	62

ITEM #	PAGE	ITEM #	PAGE	ITEM #	PAGE	ITEM #	PAGE
H-11703WSSW	62	H-22442	23	H-26921W	59	H-34444WPR	20, 21
H-11704WSSW	62	H-22442-24-FP	23	H-26992W-B	53, 59	H-34702WSSW	63
H-12443W	20, 21	H-22443	23	H-26993W	53, 59	H-34703WSSW	63
H-12443WPR	20, 21	H-22443-24-FP	23	H-26994W-B	53, 59	H-34704WSSW	63
H-12443WPR-GST	22	H-22561	64	H-28000-B	59	H-36802W	54
H-13703HV	43	H-22562	64	H-28023W	21	H-36803W	54
H-13706HV	43	H-22563	64	H-28110-B	59	H-36803W-R	54
H-14063W	21	H-22564	64	H-28111-B	59	H-36803W-R58	54
H-14443W	20, 21	H-22652W	15	H-28112	59	H-36804W	54
H-14443WPR	20, 21	H-22652W-VR	15	H-28113	59	H-36804W-R	54
H-14443WPR-GST	22	H-22653W	15	H-28114	59	H-36804W-RX	54
H-14444W	20, 21	H-22653W-BBV	16	H-28115-B	59	H-36805W	54
H-14444WPR	20, 21	H-22653W-BBV-VR	16	H-28116-B	59	H-36806W	54
H-14702WSSW	63	H-22653W-BTV	16	H-28117-B	59	H-36807W	54
H-14703WSSW	63	H-22653W-BTV-VR	16	H-28212	59	H-36823W	55
H-14704WSSW	63	H-22653W-VR	15	H-28213	59	H-36823W-R	55
H-16802W	54	H-22662W-VR	15	H-28214	59	H-36823W-R58	55
H-16803W	54	H-22663W-VR	15	H-28215-B	59	H-36824W-RX	55
H-16803W-R	54	H-26023W-12-B	59	H-28216-B	59	H-36833W	55
H-16803W-R58	54	H-26023W-15-B	59	H-28217-B	59	H-36833W-R	55
H-16804W	54	H-26023W-18	59	H-28303W	55	H-36833W-R58	55
H-16804W-R	54	H-26023W-24-B	59	H-30000-P Series	50	H-36842W	55
H-16804W-RX	54	H-26033W-12	59	H-30000W-TP	50	H-36843W	55
H-16805W	54	H-26033W-15	59	H-30202W	51	H-36843W-R	55
H-16806W	54	H-26033W-18	59	H-30203W	51	H-36843W-R58	55
H-16807W	54	H-26033W-24	59	H-30218W	51	H-36844W	55
H-16823W	55	H-26102W	58	H-30219W	51	H-36844W-R	55
H-16823W-R	55	H-26103W	58	H-30314W	51	H-36844W-RX	55
H-16823W-R58	55	H-26104W	58	H-30316W	51	H-36845W	55
H-16824W-RX	55	H-26122W	59	H-30422W	17, 46	H-36846W	55
H-16833W	55	H-26132W	58	H-30423W	17, 46	H-36847W	55
H-16833W-R	55	H-26133W	59	H-30423W-RB	21	H-36852W	56
H-16833W-R58	55	H-26143W	58	H-30424W	17, 46	H-36852W-BH	56
H-16842W	55	H-26144W	59	H-30432W	17, 45	H-36853W	56
H-16843W	55	H-26202W	58	H-30433W	17, 45	H-36853W-BH	56
H-16843W-R	55	H-26203W	58	H-30434W	17, 45	H-36854W	56
H-16843W-R58	55	H-26204W	58	H-30435W	17, 45	H-36855W	56
H-16844W	55	H-26222W	58	H-30436W	17, 45	H-36856W	56
H-16844W-R	55	H-26223W	58	H-30437W	17, 45	H-36857W	56
H-16844W-RX	55	H-26232W-B	58	H-30612W	44	H-38102W	17
H-16845W	55	H-26233W-B	58	H-30613W	44	H-38103W	17
H-16846W	55	H-26234W-B	58	H-30614W	44	H-38104W	17
H-16847W	55	H-26302W	58	H-30615W	44	H-40302W	51
H-16852W	56	H-26303W	58	H-30616W	44	H-40303W	51
H-16852W-BH	56	H-26304W	58	H-30617W	44	H-40304W	51
H-16853W	56	H-26323W	58	H-30671W-T12	49	H-40305W	51
H-16853W-BH	56	H-26332W-B	58	H-30671W-T34	49	H-40306W	51
H-16854W	56	H-26334W-B	58	H-31000-60BTM	33	H-40312W	51
H-16855W	56	H-26343W	58	H-31403W	40	H-40313W	51
H-18102W	17	H-26402W	58	H-31403WHV	40	H-40402	41
H-18103W	17	H-26403W	58	H-31404W	40	H-40403	41
H-18104W	17	H-26404W	58	H-31404WHV	40	H-40403HV	41
H-20302W	51	H-26412W	59	H-31413W	40	H-40404	41
H-20303W	51	H-26412WHE-B	59	H-31413WHV	40	H-40404HV	41
H-20304W	51	H-26421W-B	58	H-31414W	40	H-40405	41
H-20305W	51	H-26422W	58	H-31414WHV	40	H-40405HV	41
H-20306W	51	H-26432W	58	H-31702WSSW	62	H-40406	41
H-20713W	5, 21	H-26443W-B	58	H-31703WSSW	62	H-40406HV	41
H-20723-CN	21	H-26502W	58	H-31704WSSW	62	H-40407HV	41
H-20733W	21	H-26503W	58	H-31705WSSW	62	H-40413	41
H-21103W	17	H-26504W	58	H-31706WSSW	62	H-40413HV	41
H-21652W	15	H-26522W	58	H-31707WSSW	62	H-40413HVKIT	41
H-21652W-VR	15	H-26532W	58	H-32000W	7	H-40413KIT	41
H-21653W	15	H-26533W	58	H-32443W	20, 21	H-40414	41
H-21653W-DTV	16	H-26543W	58	H-32443WPR	20, 21	H-40414HV	41
H-21653W-DTV-VR	16	H-26602W	59	H-32443WPR-GST	22	H-40414HVKIT	41
H-21653W-DU	16	H-26603W	59	H-33000W	12	H-40414KIT	41
H-21653W-DU-BV	16	H-26604W	59	H-33202WSSL	51	H-40415	41
H-21653W-DU-BV-VR	16	H-26702W	59	H-34063W	21	H-40415HV	41
H-21653W-DU-VR	16	H-26703W	59	H-34443W	20, 21	H-40415HVKIT	41
H-21653W-VR	15	H-26820W	59	H-34443WPR	20, 21	H-40415KIT	41
H-21662W-VR	15	H-26821W	59	H-34443WPR-GST	20, 21	H-40416	41
H-21663W-VR	15	H-26920W	59	H-34444W	20, 21	H-40416HV	41

ITEM #	PAGE	ITEM #	PAGE	ITEM #	PAGE	ITEM #	PAGE
H-40417HV	41	H-41403W	40	H-42443WPR	20, 21	H-50415HVKIT	41
H-40422W	17, 46	H-41403WHV	40	H-42443WPR-GST	22	H-50415KIT	41
H-40423W	17, 46	H-41404	40	H-42652W	15	H-50416	41
H-40423W-RB	21	H-41404HV	40	H-42652W-VR	15	H-50416HV	41
H-40424W	17, 46	H-41404W	40	H-42653W	15	H-50417HV	41
H-40425W	17, 46	H-41404WHV	40	H-42653W-BUBV	16	H-50422W	17, 46
H-40426W	17, 46	H-41405	40	H-42653W-BUBV-VR	16	H-50423W	17, 46
H-40433	45	H-41405HV	40	H-42653W-VR	15	H-50423W-RB	21
H-40433W	17, 45	H-41405W	40	H-42662W-VR	15	H-50424W	17, 46
H-40434	45	H-41405WHV	40	H-42663W-VR	15	H-50425W	17, 46
H-40434W	17, 45	H-41406	40	H-43672	33	H-50426W	17, 46
H-40435	45	H-41406HV	40	H-43720	64	H-50433	45
H-40435W	17, 45	H-41406HV-RF375	42	H-43721	64	H-50433W	17, 45
H-40436	45	H-41406W	40	H-43722	64	H-50434	45
H-40436W	17, 45	H-41406WHV	40	H-43722-0H	64	H-50434W	17, 45
H-40443W	20, 21	H-41407HV-RF400	42	H-43723	64	H-50435	45
H-40443WPR	20, 21	H-41407WHV	40	H-43723-0H	64	H-50435W	17, 45
H-40530W	63	H-41413	40	H-43724	64	H-50436	45
H-40531W	63	H-41413HV	40	H-43724-0H	64	H-50436W	17, 45
H-40532W	63	H-41413HVKIT	41	H-43725	64	H-50443W	20, 21
H-40533W	63	H-41413KIT	41	H-43726	64	H-50443WPR	20, 21
H-40534W	63	H-41413W	40	H-43727	64	H-50562W	38
H-40562W	38	H-41413WHV	40	H-44063W	21	H-50563W	38
H-40563W	38	H-41413WHVKIT	41	H-44443W	20, 21	H-50564W	38
H-40564W	38	H-41413WKIT	41	H-44443WPR	20, 21	H-50565W	38
H-40565W	38	H-41414	40	H-44443WPR-GST	22	H-50566W	38
H-40566W	38	H-41414HV	40	H-44444	27	H-50567W	38
H-40567W	38	H-41414HVKIT	41	H-44444PR3	27	H-50612	44
H-40612	44	H-41414KIT	41	H-44444W	20, 21, 27	H-50612W	44
H-40612W	44	H-41414W	40	H-44444WPR	20, 21	H-50613	44
H-40613	44	H-41414WHV	40	H-44444WPR3	27	H-50613W	44
H-40613W	44	H-41414WHVKIT	41	H-44672	33	H-50614	44
H-40614	44	H-41414WKIT	41	H-45443WPR	20, 21	H-50614W	44
H-40614W	44	H-41415	40	H-45443WPR-LH	20, 21	H-50615	44
H-40615	44	H-41415HV	40	H-48354-43	26	H-50615W	44
H-40615W	44	H-41415HVKIT	41	H-48354-44	26	H-50616	44
H-40616	44	H-41415KIT	41	H-48613	50	H-50616W	44
H-40616W	44	H-41415W	40	H-48614	50	H-50617	44
H-40617	44	H-41415WHV	40	H-48615	50	H-50617W	44
H-40617W	44	H-41415WHVKIT	41	H-48616	50	H-50622W	64
H-40622W	64	H-41415WKIT	41	H-48754-43	26	H-50623W	64
H-40623W	64	H-41416	40	H-48754-44	26	H-50624W	64
H-40624W	64	H-41416HV	40	H-48765-45	26	H-50672W	50
H-40632W	62	H-41416HV-RF375	42	H-48854-43	26	H-50673W	50
H-40633W	62	H-41416W	40	H-48854-44	26	H-50674W	50
H-40634W	62	H-41416WHV	40	H-48865-45	26	H-50675W	50
H-40642	64	H-41417HV-RF475	42	H-50302W	51	H-50676W	50
H-40643	64	H-41417WHV	40	H-50303W	51	H-50677W	50
H-40644	64	H-41562W	39	H-50304W	51	H-50682	63
H-40702	62	H-41563W	39	H-50305W	51	H-50702	62
H-40702W	62	H-41564W	39	H-50306W	51	H-50702W	62
H-40702WSSW	62	H-41565W	39	H-50312W	51	H-50703	62
H-40703	62	H-41652W	15	H-50313W	51	H-50703W	62
H-40703W	62	H-41652W-VR	15	H-50402	41	H-50704	62
H-40703WSSW	62	H-41653W	15	H-50403	41	H-50704W	62
H-40704	62	H-41653W-DU-BV	16	H-50403HV	41	H-50705	62
H-40704W	62	H-41653W-DU-BV-VR	16	H-50404	41	H-50705W	62
H-40704WSSW	62	H-41653W-VR	15	H-50404HV	41	H-50706	62
H-40705	62	H-41662W-VR	15	H-50405	41	H-50706W	62
H-40705W	62	H-41663W-VR	15	H-50405HV	41	H-50707	62
H-40706	62	H-41672	33	H-50406	41	H-50707W	62
H-40706W	62	H-41685	63	H-50406HV	41	H-51403	40
H-40707	62	H-41686	63	H-50407HV	41	H-51403HV	40
H-40707W	62	H-41687	63	H-50413	41	H-51403W	40
H-40782	64	H-41698	63	H-50413HV	41	H-51403WHV	40
H-40802W	64	H-41699	63	H-50413HVKIT	41	H-51404	40
H-40803W	64	H-41722	64	H-50413KIT	41	H-51404HV	40
H-40804W	64	H-41723	64	H-50414	41	H-51404W	40
H-40805W	64	H-41724	64	H-50414HV	41	H-51404WHV	40
H-40806W	64	H-41725	64	H-50414HVKIT	41	H-51405	40
H-40807W	64	H-41726	64	H-50414KIT	41	H-51405HV	40
H-41403	40	H-41727	64	H-50415	41	H-51405W	40
H-41403HV	40	H-42443W	20, 21	H-50415HV	41	H-51405WHV	40

ITEM #	PAGE	ITEM #	PAGE	ITEM #	PAGE	ITEM #	PAGE
H-51406	40	H-54614W	44	H-71273W-Y-TG	10	H-74262W	11
H-51406HV	40	H-55443WPR	20, 21	H-72003-V	31	H-74263W	11
H-51406HV-RF375	42	H-55443WPR-LH	20, 21	H-72004-V	31	H-74264W	11
H-51406W	40	H-58354-53	26	H-72202W	11	H-74272W	11
H-51406WHV	40	H-58354-54	26	H-72202W-CAN	11	H-74272W-Y	10
H-51407HV-RF400	42	H-58613	50	H-72202W-Y	10	H-74272W-Y-TG	10
H-51407HV-RF475	42	H-58614	50	H-72202W-Y-TG	10	H-74273W	11
H-51407WHV	40	H-58615	50	H-72203W	11	H-74273W-Y	10
H-51413	40	H-58616	50	H-72203W-CAN	11	H-74273W-Y-TG	10
H-51413HV	40	H-58643	29	H-72203W-Y	10	H-74274W	11
H-51413HVKIT	41	H-58644	29	H-72203W-Y-TG	10	H-74274W-Y	10
H-51413KIT	41	H-58653	29	H-72204W	11	H-74274W-Y-TG	10
H-51413W	40	H-58654	29	H-72204W-CAN	11	H-74313W	13
H-51413WHV	40	H-58655	29	H-72204W-Y	10	H-74323W	13
H-51413WHVKIT	41	H-58754-53	26	H-72204W-Y-TG	10	H-74404	28
H-51413WKIT	41	H-58754-54	26	H-72262W	11	H-74405	28
H-51414	40	H-58765-55	26	H-72263W	11	H-74406	28
H-51414HV	40	H-58854-53	26	H-72264W	11	H-74533	29
H-51414HVKIT	41	H-58854-54	26	H-72272W	11	H-74533-A	29
H-51414KIT	41	H-58865-55	26	H-72272W-Y	10	H-74544	29
H-51414W	40	H-60422W	17, 46	H-72272W-Y-TG	10	H-74544-A	29
H-51414WHV	40	H-60423W	17, 46	H-72273W	11	H-74600	30
H-51414WHVKIT	41	H-60424W	17, 46	H-72273W-Y	10	H-74601	30
H-51414WKIT	41	H-60670W-T12	49	H-72273W-Y-TG	10	H-74602	30
H-51415	40	H-60670W-T34	49	H-72274W	11	H-74613	32
H-51415HV	40	H-60671W-T12	49	H-72274W-Y	10	H-74703	35
H-51415HVKIT	41	H-60671W-T34	49	H-72274W-Y-TG	10	H-74704	35
H-51415KIT	41	H-61652W	15	H-72404	28	H-74705	34
H-51415W	40	H-61652W-VR	15	H-72405	28	H-74706	34
H-51415WHV	40	H-61653W	15	H-72406	28	H-74713	35
H-51415WHVKIT	41	H-61653W-VR	15	H-72533	29	H-74714	35
H-51415WKIT	41	H-61662W-VR	15	H-72533-A	29	H-75003	30
H-51416	40	H-61663W-VR	15	H-72544	29	H-75003-V	31
H-51416HV	40	H-62023W-18	59	H-72544-A	29	H-75004	30
H-51416HV-RF375	42	H-62033W-18	59	H-72703	35	H-75004-V	31
H-51416W	40	H-62652W	15	H-72704	35	H-75005	30
H-51416WHV	40	H-62652W-VR	15	H-72705	34	H-75006	30
H-51416WHVKIT	41	H-62653W	15	H-72706	34	H-75007	30
H-51417WHV	40	H-62653W-VR	15	H-72713	35	H-75202W	11
H-51417WHVKIT	41	H-62662W-VR	15	H-72714	35	H-75202W-CAN	11
H-51652W	15	H-62663W-VR	15	H-73202W-CE	11	H-75202W-Y	10
H-51652W-VR	15	H-62702W	58, 62	H-73202W-CE-CAN	11	H-75202W-Y-TG	10
H-51653W	15	H-62703W	58, 62	H-73202W-Y	10	H-75203W	11
H-51653W-DU	16	H-62704W	58, 62	H-73202W-Y-TG	10	H-75203W-CAN	11
H-51653W-DU-BV	16	H-64063W	21	H-73203W-CE	11	H-75203W-Y	10
H-51653W-DU-BV-VR	16	H-64443W	20, 21	H-73203W-CE-CAN	11	H-75203W-Y-TG	10
H-51653W-DU-VR	16	H-64443WPR	20, 21	H-73203W-Y	10	H-75204W	11
H-51653W-VR	15	H-64443WPR-GST	22	H-73203W-Y-TG	10	H-75204W-CAN	11
H-51662W-VR	15	H-70000W	11	H-73272W	11	H-75204W-Y	10
H-51663W-VR	15	H-70000W-CAN	11	H-73272W-Y	10	H-75204W-Y-TG	10
H-52443W	20, 21	H-70000W-Y	10	H-73272W-Y-TG	10	H-75262W	11
H-52443WPR	20, 21	H-70060W	11	H-73273W	11	H-75263W	11
H-52443WPR-GST	22	H-70070W	11	H-73273W-Y	10	H-75264W	11
H-52652W	15	H-70070W-Y	10	H-73273W-Y-TG	10	H-75272W	11
H-52652W-VR	15	H-70530	7, 29	H-74000	31	H-75272W-Y	10
H-52653W	15	H-70530-A	7, 29	H-74003	30	H-75272W-Y-TG	10
H-52653W-BUBV	16	H-70540	7, 29	H-74003-V	31	H-75273W	11
H-52653W-BUBV-VR	16	H-70540-A	7, 29	H-74004	30	H-75273W-Y	10
H-52653W-VR	15	H-70700	7, 35	H-74004-V	31	H-75273W-Y-TG	10
H-52662W-VR	15	H-70706	7, 34	H-74005	30	H-75274W	11
H-52663W-VR	15	H-71000-V	7, 31	H-74006	30	H-75274W-Y	10
H-54063W	21	H-71202W	11	H-74007	30	H-75274W-Y-TG	10
H-54103W	17	H-71202W-CAN	11	H-74202W	11	H-75404	28
H-54443W	20, 21	H-71202W-Y	10	H-74202W-CAN	11	H-75405	28
H-54443WPR	20, 21	H-71202W-Y-TG	10	H-74202W-Y	10	H-75406	28
H-54443WPR-GST	22	H-71203W	11	H-74202W-Y-TG	10	H-75533	29
H-54444W	20, 21, 27	H-71203W-CAN	11	H-74203W	11	H-75533-A	29
H-54444WPR	20, 21	H-71203W-Y	10	H-74203W-CAN	11	H-75544	29
H-54444WPR3	27	H-71203W-Y-TG	10	H-74203W-Y	10	H-75544-A	29
H-54612	44	H-71272W	11	H-74203W-Y-TG	10	H-75703	35
H-54612W	44	H-71272W-Y	10	H-74204W	11	H-75704	35
H-54613	44	H-71272W-Y-TG	10	H-74204W-CAN	11	H-75705	34
H-54613W	44	H-71273W	11	H-74204W-Y	10	H-75706	34
H-54614	44	H-71273W-Y	10	H-74204W-Y-TG	10	H-75713	35

ITEM #	PAGE	ITEM #	PAGE	ITEM #	PAGE	ITEM #	PAGE
H-75714	35	H-80304W	51	H-81105W	17	H-81653W-DUBV-VR	16
H-76202W	11	H-80305W	51	H-81106W	17	H-81653W-DU-VR	16
H-76202W-CAN	11	H-80306W	51	H-81107W	17	H-81653W-VR	15
H-76202W-Y	10	H-80312W	51	H-81112W	17	H-81662W-VR	15
H-76202W-Y-TG	10	H-80313W	51	H-81113W	17	H-81663W-VR	15
H-76203W	11	H-80332W	63	H-81114W	17	H-81702W	62
H-76203W-CAN	11	H-80333W	63	H-81115W	17	H-81703W	62
H-76203W-Y	10	H-80334W	63	H-81116W	17	H-81704W	62
H-76203W-Y-TG	10	H-80335W	63	H-81117W	17	H-81705W	62
H-77201W	12	H-80336W	63	H-81122W	17	H-81706W	62
H-77201W-T	12	H-80337W	63	H-81123W	17	H-81707W	62
H-77201W-TG	12	H-80422W	17, 46	H-81124W	17	H-81708W	62
H-77211W	12	H-80423W	17, 46	H-81125W	17	H-81709W	62
H-77211W-TG	12	H-80423W-RB	21	H-81126W	17	H-81710W	62
H-77401W	12	H-80424W	17, 46	H-81127W	17	H-82652W	15
H-77401W-TG	12	H-80425W	17, 46	H-81403	40	H-82652W-VR	15
H-77411W	12	H-80426W	17, 46	H-81403HV	40	H-82653W	15
H-77411W-TG	12	H-80433W	17, 45	H-81403W	40	H-82653W-BTV	16
H-77610W	12	H-80434W	17, 45	H-81403WHV	40	H-82653W-BTV-VR	16
H-77610W-TG	12	H-80435W	17, 45	H-81404	40	H-82653W-BUBV	16
H-78003	30	H-80436W	17, 45	H-81404HV	40	H-82653W-BUBV-VR	16
H-78003-V	31	H-80562W	38	H-81404W	40	H-82653W-VR	15
H-78004	30	H-80563W	38	H-81404WHV	40	H-82662W-VR	15
H-78004-V	31	H-80564W	38	H-81405	40	H-82663W-VR	15
H-78005	30	H-80565W	38	H-81405HV	40	H-82672W	49
H-78006	30	H-80566W	38	H-81405W	40	H-82672W-T34	49
H-78007	30	H-80567W	38	H-81405WHV	40	H-82673W	49
H-78202W	11	H-80612	44	H-81406	40	H-82673W-T12	49
H-78202W-CAN	11	H-80612W	44	H-81406HV	40	H-82674W	49
H-78202W-Y	10	H-80613	44	H-81406W	40	H-82674W-T114	49
H-78202W-Y-TG	10	H-80613W	44	H-81406WHV	40	H-82675W	49
H-78203W	11	H-80614	44	H-81407HV	40	H-82702W	63
H-78203W-CAN	11	H-80614W	44	H-81407HV-RF400	42	H-82703W	63
H-78203W-Y	10	H-80615	44	H-81407WHV	40	H-82704W	63
H-78203W-Y-TG	10	H-80615W	44	H-81413	40	H-82705W	63
H-78204W	11	H-80616	44	H-81413HV	40	H-82706W	63
H-78204W-CAN	11	H-80616W	44	H-81413HVKIT	41	H-82707W	63
H-78204W-Y	10	H-80617	44	H-81413W	40	H-82712W	47
H-78204W-Y-TG	10	H-80617W	44	H-81413WHV	40	H-82713W	47
H-78262W	11	H-80622W	64	H-81414	40	H-82714W	47
H-78263W	11	H-80623W	64	H-81414HV	40	H-83612W	44
H-78264W	11	H-80624W	64	H-81414HVKIT	41	H-83613W	44
H-78272W	11	H-80633W-T114	46	H-81414W	40	H-83614W	44
H-78272W-Y	10	H-80634W-T112	46	H-81414WHV	40	H-83615W	44
H-78272W-Y-TG	10	H-80634W-T114	46	H-81415	40	H-83616W	44
H-78273W	11	H-80635W-T112	46	H-81415HV	40	H-83617W	44
H-78273W-Y	10	H-80642W	48	H-81415HVKIT	41	H-83712W	47
H-78273W-Y-TG	10	H-80643W	48	H-81415W	40	H-83713W	47
H-78274W	11	H-80644W	48	H-81415WHV	40	H-83713W-T114	47
H-78274W-Y	10	H-80645W	48	H-81416	40	H-83714W	47
H-78274W-Y-TG	10	H-80646W	48	H-81416HV	40	H-83714W-T112	47
H-78313W	13	H-80647W	48	H-81416HV-RF375	42	H-83714W-T114	47
H-78323W	13	H-80670W-T12	49	H-81416W	40	H-83715W-T112	47
H-78404	28	H-80670W-T34	49	H-81416WHV	40	H-84063W	21
H-78405	28	H-80671W-T12	49	H-81417HV	40	H-84443W	20, 21
H-78406	28	H-80671W-T34	49	H-81417WHV	40	H-84443WPR	20, 21
H-78533	29	H-80672W	50	H-81424HV	43	H-84443WPR-GST	22
H-78533-A	29	H-80673W	50	H-81562W	39	H-84444W	20, 21, 27
H-78544	29	H-80674W	50	H-81563W	39	H-84444WPR	20, 21
H-78544-A	29	H-80675W	50	H-81564W	39	H-84444WPR3	27
H-78703	35	H-80692W	53	H-81565W	39	H-84613	44
H-78704	35	H-80693W	53	H-81612W	44	H-84614	44
H-78705	34	H-80694W	53	H-81613W	44	H-84702W	63
H-78706	34	H-80695W	53	H-81614W	44	H-84703W	63
H-78713	35	H-80696W	53	H-81615W	44	H-84704W	63
H-78714	35	H-80742W	48	H-81616W	44	H-84705W	63
H-80132W	63	H-80743W	48	H-81617W	44	H-84706W	63
H-80133W	63	H-80744W	48	H-81652W	15	H-84707W	63
H-80134W	63	H-80745W	48	H-81652W-VR	15	H-85443WPR	20, 21
H-80135W	63	H-80746W	48	H-81653W	15	H-85443WPR-LH	20, 21
H-80136W	63	H-80747W	48	H-81653W-DTV	16	H-86152W	56
H-80137W	63	H-81102W	17	H-81653W-DTV-VR	16	H-86153W	56
H-80302W	51	H-81103W	17	H-81653W-DU	16	H-86153W-R	56
H-80303W	51	H-81104W	17	H-81653W-DUBV	16	H-86154W	56

ITEM #	PAGE	ITEM #	PAGE	ITEM #	PAGE	ITEM #	PAGE
H-86154W-R	56	H-88654	29	H-G7676W	7, 49	H-x053 Series	63
H-86155W	56	H-88655	29	H-G9203W-R	14	H-x056 Series	38
H-86163W	57	H-88754-43	26	H-G-80612W	6, 7, 45	H-x061 Series	44
H-86163W-R	57	H-88754-44	26	H-G-80613W	6, 7, 45	H-x062 Series	64
H-86164W-R	57	H-88765-45	26	H-G-80614W	6, 7, 45	H-x063 Series	46
H-86173W	57	H-88854-43	26	H-G-80616W	6, 7, 45	H-x064 Series	48
H-86173W-R	57	H-88854-44	26	H-G-80616W-R	6, 7, 45	H-x067 Series	50
H-86174W-R	57	H-88865-45	26	H-G-80617W	6, 7, 45	H-x068 Series	63
H-86202W	54	H-101403WHV	61	H-G-81704W	6, 7, 63	H-x069 Series	53
H-86202W-R	54	H-101404WHV	61	H-G-81704W-R	6, 7, 63	H-x074 Series	48
H-86202W-RX	54	H-101405WHV	61	H-G-81704W-R12	6, 7, 63	H-x078 Series	64
H-86203W	54	H-101406WHV	61	H-G-81706W	6, 7, 63	H-x080 Series	64
H-86203W-R	54	H-101407WHV	61	H-G-81706W-R	6, 7, 63	H-x110 Series	17
H-86203W-RX	54	H-101702W	61	H-G-81707W	6, 7, 63	H-x111 Series	17
H-86204W	54	H-101703W	61	H-G-81707W-R	6, 7, 63	H-x112 Series	17
H-86204W-R	54	H-101704W	61	H-GKIT1 Series	5	H-x140-RF Series	42
H-86242W	55	H-101705W	61	H-GKIT1W	5	H-x140 Series	40
H-86242W-R	55	H-101706W	61	H-GX56-RS Series	38	H-x141KIT Series	41
H-86242W-RX	55	H-101707W	61	H-G-x061 Series	6, 45	H-x141-RF Series	42
H-86243W	55	H-104702W	61	H-G-x170 Series	6, 63	H-x141 Series	40
H-86243W-R	55	H-104703W	61	H-GX562W-40M	38	H-x156 Series	39
H-86243W-RX	55	H-104704W	61	H-GX563W-40M	38	H-x165-DTV Series	16
H-86244W	55	H-104705W	61	H-GX565W-40M	38	H-x165-DTV-VR Series	16
H-86244W-R	55	H-104706W	61	H-GX566W-40M	38	H-x165-DU-BV Series	16
H-86352W	56	H-104707W	61	H-GX567W-40M	38	H-x165-DUBV Series	16
H-86353W	56	H-C7-203	11	H-HC-CNBPK Series	26	H-x165-DU-BV-VR Series	16
H-86353W-R	56	H-C7-303	11	H-HCE4-43	27	H-x165-DUBV-VR Series	16
H-86354W	56	H-FSTR4-54	38	H-HCE4-44	27	H-x165-DU Series	16
H-86354W-R	56	H-G6G6 Series	57	H-HCE4-53	27	H-x165-DU-VR Series	16
H-86355W	56	H-G6G64W	7, 57	H-HCE4-54	27	H-x165 Series	15, 25
H-86356W	56	H-G14x Series	6	H-HCE4-63	27	H-x165-VR Series	15
H-86357W	56	H-G030 Series	51	H-HCE4-64	27	H-x166-VR Series	15
H-86363W	57	H-G056 Series	38	H-HCE4-74	27	H-x167 Series	33
H-86363W-R	57	H-G061 Series	6, 45	H-HCE4-94	27	H-x168 Series	63
H-86364W-R	57	H-G067 Series	13	H-HCE5-44	27	H-x170 Series	62, 63
H-86373W	57	H-G156 Series	39	H-HCE5-45	27	H-x172 Series	64
H-86373W-R	57	H-G165 Series	15	H-HCE5-54	27	H-x244-GST Series	22
H-86374W-R	57	H-G166 Series	15	H-HCE5-55	27	H-x244PR Series	20
H-86402W	54	H-G170 Series	6, 63	H-HCE5-74	27	H-x244 Series	20
H-86402W-R	54	H-G244-GST Series	22	H-HCE5-75	27	H-x265-BBV Series	16
H-86402W-RX	54	H-G244 Series	20	H-HCE-PUMP Series	38	H-x265-BBV-VR Series	16
H-86403W	54	H-G265 Series	15	H-HCM-DBD Series	26	H-x265-BTV Series	16
H-86403W-R	54	H-G266 Series	15	H-HCM-LEFT Series	26	H-x265-BTV-VR Series	16
H-86403W-RX	54	H-G0304W	7, 51	H-HCM-RGHT Series	26	H-x265-BUBV Series	16
H-86404W	54	H-G0306W	7, 51	H-HC-UN Series	27	H-x265-BUBV-VR Series	16
H-86404W-R	54	H-G0564W	7, 38	H-Hosebibb Series	51	H-x265 Series	15
H-86442W	55	H-G0566W	7, 38	H-LV02489-02	38	H-x265-VR Series	15
H-86442W-R	55	H-G0614W	5, 6, 7, 45	H-LV02490-02	38	H-x266-VR Series	15
H-86442W-RX	55	H-G0616W	6, 7, 45	H-LV02492-02	38	H-x267 Series	49
H-86443W	55	H-G0616W-R	6, 7, 45	H-LV02493-02	38	H-x271 Series	47
H-86443W-R	55	H-G0617W	6, 7, 45	H-LV02494-02	38	H-x367 Series	33
H-86443W-RX	55	H-G0617W-R	6, 7, 45	H-SE917 Series	61	H-x371 Series	47
H-86444W	55	H-G0673W	13	H-SE-91704	61	H-x372 Series	64
H-86444W-R	55	H-G767 Series	49	H-SE-91705	61	H-x406 Series	21
H-86452W	56	H-G1404W	6	H-SE-91706	61	H-x410 Series	17
H-86452W-R	56	H-G1404WHV	6	H-SE-91707	61	H-x444-GST Series	22
H-86453W	56	H-G1414W	6	H-Sillcock Series	51	H-x444PR3 Series	27
H-86453W-R	56	H-1414WHV	6	H-TMV-120 Series	9, 11	H-x444PR Series	20
H-86453W-R14	56	H-G1564W	7, 39	H-TMV-131 Series	9, 11	H-x444 Series	20, 27
H-86454W-R12	56	H-G1566W	7, 39	H-TMV-131-Y Series	9, 10	H-x461 Series	44
H-86603W	57	H-G1653W	7, 15	H-TMV-131-Y-TG Series	9, 10	H-x544-LH Series	20
H-86604W	57	H-G1663W	7, 15	H-TMV-176 Series	9, 11	H-x544 Series	20
H-88343-2	25	H-G1704W	5, 6, 7, 63	H-TMV-176-Y Series	9, 10	H-x660 Series	57
H-88344-2	25	H-G1706W	6, 7, 63	H-TMV-176-Y-TG Series	9, 10	H-x680 Series	54
H-88354-2	25	H-G1706W-R	6, 7, 63	H-TMV-230F Input Series	9, 11	H-x682 Series	55
H-88354-43	26	H-G1707W	6, 7, 63	H-x030 Series	51	H-x683 Series	55
H-88354-44	26	H-G1707W-R	6, 7, 63	H-x031 Series	51	H-x684 Series	55
H-88355-2	25	H-G2444W-R	7, 20, 21	H-x040 Series	41	H-x685 Series	56
H-88613	50	H-G2444W-RPR	7, 20, 21	H-x041KIT Series	41	H-x810 Series	17
H-88614	50	H-G2444W-R-PR-GST	7, 22	H-x041 Series	41	H-x861 Series	50
H-88615	50	H-G2653W	7, 15	H-x042-RB Series	21	H-x864 Series	29
H-88616	50	H-G2663W	7, 15	H-x042 Series	17, 46	H-x-G244-GST Series	22
H-88643	29	H-G7674W	7, 49	H-x043 Series	17, 45	H-x-G244 Series	20
H-88644	29	H-G7674W-T112	7, 49	H-x044 Series	20		

Terms and Conditions of Sale

All NIBCO INC. ("NIBCO") products are sold or otherwise furnished in accordance with these Terms and Conditions of Sale. Any provision of a purchase order or other documentation submitted by customer that conflicts with these Terms and Conditions shall not be binding upon NIBCO. These Terms and Conditions supersede all prior terms and conditions.

NIBCO reserves the right to change, without notice, all list prices or discount schedules. All prices are effective at the time of order unless otherwise stated in writing by NIBCO and except in cases of tariffs or other unexpected events substantially affecting the cost of the products being sold. Sales, use, excise and other federal, state or local taxes relating to goods sold and delivered are the responsibility of the customer/buyer. A fuel surcharge may be applied to all orders contingent upon NIBCO discretion and fuel costs. All orders, including direct shipments, must be shipped in NIBCO determined box quantities.

A finance charge of 1.5% per month or the maximum allowable under the applicable state law will be charged for overdue accounts. NIBCO reserves the right at any time to suspend credit or to change credit terms provided herein, when, in NIBCO's sole opinion, customers financial condition so warrants such suspension and/or change of terms, unless NIBCO determines otherwise. The failure of customer to pay invoices at maturity date shall cause all subsequent invoices immediately due and payable irrespective of terms. Further NIBCO may withhold all subsequent deliveries until the full account is settled and NIBCO shall not, in such event, be liable for nonperformance of contract in whole or in part.

Product Returns

Warranty Returns/Wrong Goods Shipped (NIBCO Responsible). In the event that a NIBCO product is being returned under the applicable NIBCO limited warranty or because NIBCO shipped the wrong product(s), then a NIBCO Return Goods Authorization (RGA) form is required. If NIBCO determines that the wrong product was shipped, then a full credit for the purchase price of the product will be issued. NIBCO shall have the option to field destroy any such product(s).

Customer Request. Products may be returned at the discretion of NIBCO by customer subject to the following conditions: (i) all returns must be made within 12 months from shipment; (ii) NIBCO Return Goods Authorization (RGA) paperwork is required for all product returns; (iii) any NIBCO product that a customer requests to return must be of current design, in clean, resalable condition in original packaging and in NIBCO determined box quantities. NIBCO may request to inspect any products prior to their return to NIBCO. NIBCO will not accept returns of obsolete or discontinued products.

Product returns will not be granted in the months of November and December of any year unless such return is being made as a warranty return or in the event that a NIBCO error was made in the processing or fulfillment of the original order.

Purchase order or invoice numbers are required for all returns. Credit will be issued for product returns acceptable to NIBCO minus a 20% inspection and handling surcharge for stocked material, 30% inspection and handling surcharge for assembled-to-order material. In the event that NIBCO chooses to accept a returned product without a purchase order or invoice, then NIBCO, in its sole discretion, shall determine the value of the products returned. Freight prepaid by customer on all product returns. No return of non-stock or Made-to-Order product will be allowed. No product returns less than \$100 will be allowed.

Shipping Claims. All claims for shipping damages, shortages or inaccuracies on a NIBCO shipment shall be waived, unless made in writing and delivered to NIBCO within five (5) days after customer's receipt of material. Any discrepancies or damage to a NIBCO shipment must be noted on the delivery receipt before the driver leaves customer's facility. Signing "free and clear" of any type of damage or missing skid(s) means you have accepted the shipment as being complete. For Collect Shipments, shipping charges being paid by the customer, all lost in transit and damaged shipment claims shall be made directly with the carrier.

Made-to-Order Items. Orders for Made-to-Order items may not be canceled. Made-to-Order products may not be returned. Delivery of Made-to-Order products is based upon quoted estimated manufacturing lead-time.

The shipping basis is FOB NIBCO's manufacturing or distribution center and the Bill of Lading signed for by the carrier will be conclusive evidence as to the shipment of the property as described therein, on the date of signature. For Alaska and Hawaii ship to destinations the shipping basis is FOB customers designated freight forwarder. NIBCO is not responsible for freight charges from the U.S. port to the end destination. Freight, transportation and shipping charges shall be paid by customer unless minimum NIBCO threshold limit is met; please consult with NIBCO Customer Service regarding applicable minimum threshold shipping limits. Alaska and Hawaii ship to destinations that exceed the minimum NIBCO threshold limit, shipping basis is FOB final destination in Alaska or in Hawaii.

Disclaimer of Warranties. NIBCO products are covered by their respective limited warranties, copies of which are published in NIBCO's sales materials and will be made available to any customer upon request. NIBCO's limited warranties for all of its products are available on NIBCO's website at www.nibco.com. NIBCO MAKES NO OTHER WARRANTIES, EXPRESS OR IMPLIED, AND, TO THE EXTENT PERMITTED BY LAW, EXCLUDES ANY WARRANTY OF MERCHANTABILITY AND FITNESS FOR A PARTICULAR PURPOSE. NO PERSON IS AUTHORIZED TO EXTEND ADDITIONAL WARRANTIES ON NIBCO'S BEHALF.

Limitation of Liability. IN NO EVENT SHALL NIBCO BE LIABLE FOR ANY INDIRECT, SPECIAL, INCIDENTAL, EXEMPLARY, PUNITIVE OR CONSEQUENTIAL DAMAGES, INCLUDING LOST PROFITS OR OTHER ECONOMIC LOSS.

Force Majeure. NIBCO is not liable for any loss or damage resulting from failure to deliver or delay caused by acts of God, transportation delays, accidents, fire, strike, civil or military authority, or any other cause which is unforeseen or beyond NIBCO's control, including tariffs. Customer waives any obligation of NIBCO to notify it of any such delay.

Customer Service. For quality assurance purposes NIBCO records all inbound and outbound Customer Service calls.

NIBCO's Terms and Conditions of Sale, including the quoted price, are subject to modification at any time, and for any reason, in NIBCO's sole discretion. A modification may be either on an individual or channel basis, as necessary to meet NIBCO's business needs.

Revised January 31, 2024

Third Party Approvals and Standards Organizations



CSA Group
www.csagroup.org

IAPMO R&T
www.iapmort.org



Unless otherwise designated, lead-free certification (NSF/ANSI/CAN 61 & 372) was performed by ALS Group USA, Corp - Truesdail Laboratories.
www.truesdail.com



Certified to the Uniform Plumbing Code

Note:

Third Party Approval Agencies often can approve products to a wide variety of standards; some of the standards may be under the responsibility of another agency. For example, IAPMO can issue approvals to NSF/ANSI 61 standard, as can ALS, CSA, etc.

Product identified as being constructed of Lead-Free Brass have a maximum weighted average lead content of 0.25% of the wetted surface of the product in accordance with the requirements of the Reduction of Lead in Drinking Water Act.

Product identified as being constructed of standard brass have a lead content in excess of the 0.25% limit and are not to be used in potable water systems.

Pressure Relief Valve capacity ratings listed are the ASME National Board value.

Definition of Terms

CWP: Cold Working Pressure: This designates the maximum non-shock operating pressure of the product. The "Cold" is defined as temperatures in the range from above freezing to 100°F. Above 100°F the maximum allowable pressure decreases as listed in the product specification sheet.

WSP: Working Steam Pressure: Indicates the maximum steam pressure of the product. This rating is independent from the CWP rating. The WSP rating is lower than the CWP rating.

Webstone[®]

a brand of **NIBCO[®]**

WORK SMARTER

www.webstonevalves.com
webstone@nibco.com

